

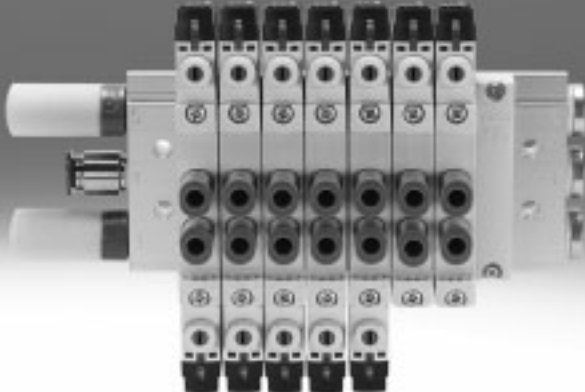

Solenoid valves VUVG/valve terminals VTUG



 **New**
VUVG-LK, VUVG-BK

Solenoid valves VUVG

Key features

FESTO

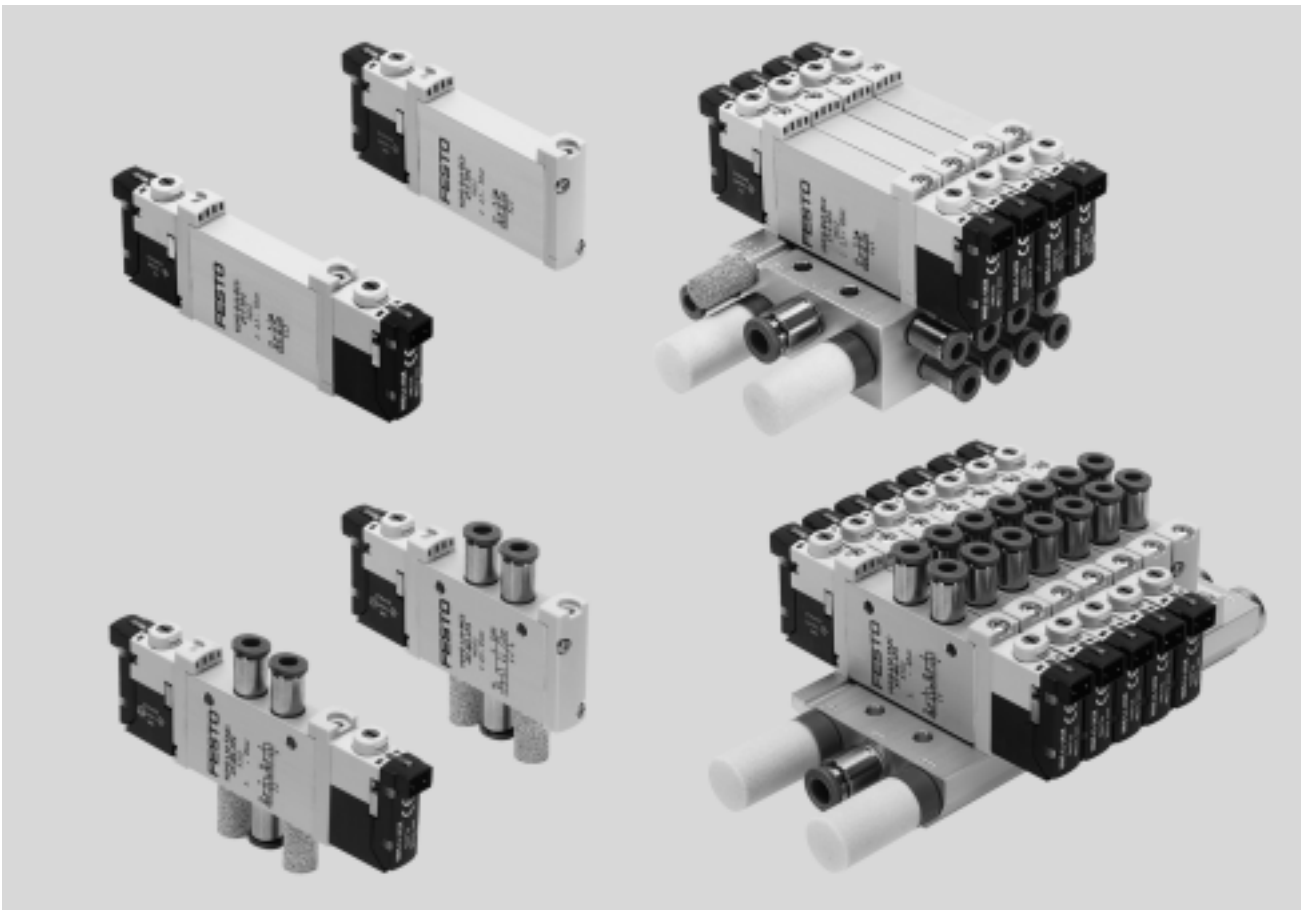

Innovative

- Can be set to internal or external pilot air supply for manifolds with sub-base valves
- Connection technology easy to change via the electrical connection box
- Maximum pressure 10 bar
- Design principle:
 - Piston spool with sealing cartridge (VUVG-L, VUVG-B)
 - Piston spool with sealing ring (VUVG-LK, VUVG-BK)

Versatile

- Wide range of valve functions
- Choice of quick plug connectors
- In-line valves can be used as individual valves or manifold valves
- M5 and M7 in-line valves can be combined on one manifold rail
- Identical sub-base valves for M5 or M7 manifold rail
- Manifolds with pressure zones
- IP40, IP65

Reliable

- Sturdy and durable metal components
 - Valves
 - Manifold rails
- Fast troubleshooting thanks to 360° LED display
- Convenient servicing thanks to valves that can be replaced quickly and easily
- Choice of manual override: non-detenting, covered, non-detenting/detenting or detenting (without accessories)

Easy to install

- Secure mounting on wall or H-rail
- Easy mounting thanks to captive screws and seal
- Connection technology easy to change via the electrical connection box
- Inscription label holder for labelling the valves

Valve terminal configurator

A valve terminal configurator is available to help you select a suitable valve terminal VTUG. This makes it much easier to order the right product. Valve terminals VTUG are ordered via an ident. code.

All valve terminals are supplied fully assembled and individually tested. This reduces assembly and installation time to a minimum.

Ordering system for valve terminal VTUG

➔ Internet: vtug

Download CAD data ➔ www.festo.com

Solenoid valves VUVG

Key features – Pneumatic components

Individual valves and valve manifolds

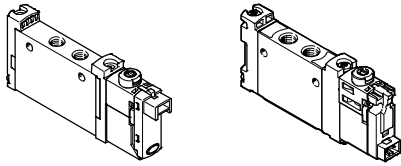

In-line valve VUVG-L/VUVG-LK as individual valve

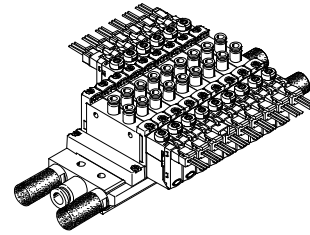

Valve manifold VTUG consisting of in-line valves VUVG-S

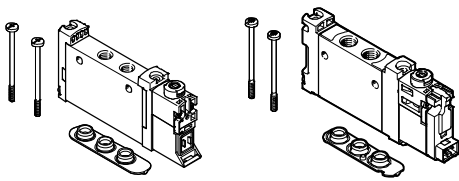

In-line valve VUVG-S/VUVG-SK, VUVG-LK for manifold assembly

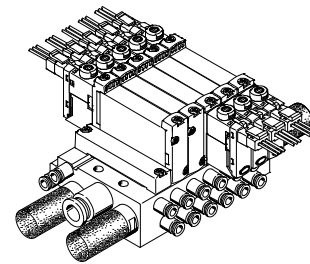

Valve manifold VTUG consisting of Sub-base valves VUVG-B

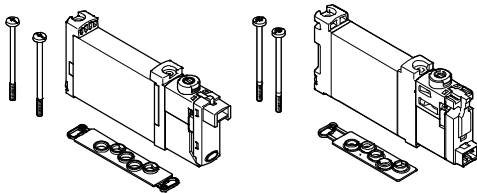

Sub-base valve VUVG-B/VUVG-BK for manifold assembly

Basic valves VUVG

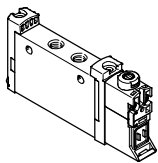

- Valve size 10 mm, 14 mm and 18 mm
- In-line valves
- Sub-base valves
- 2x3/2-way, 5/2-way and 5/3-way valves

Electrical connection boxes

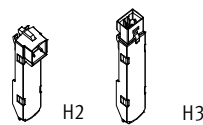

- 5, 12 and 24 V DC
- With or without holding current reduction
- LED

Basic valve and electrical connection box combinations

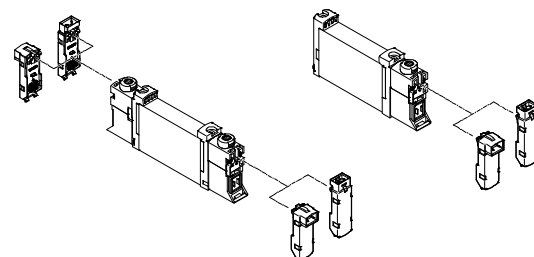
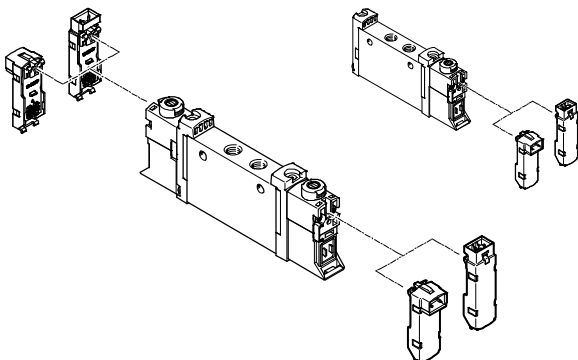

Note
More electrical connection boxes
→ page 103

Solenoid valves VUVG

Key features – Pneumatic components

Cover caps for manual override

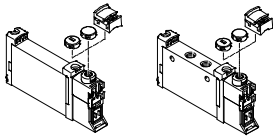

- Closed cover cap, covered manual override
- Slotted cover cap, non-detenting manual override
- Cover, detenting manual override

Inscription label holder

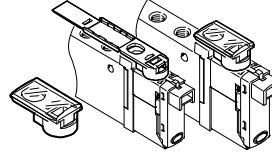

- The inscription label holder is mounted in the same way as a cover cap for manual override
- The hinged inscription label holder covers the mounting screw and the manual override

Valve terminal configurator

Download CAD data → www.festo.com

A valve terminal configurator is available to help you select a suitable valve terminal VTUG. This makes it much easier to order the right product. Valve terminals VTUG are ordered via an ident. code.

All valve terminals are supplied fully assembled and individually tested. This reduces assembly and installation time to a minimum.

Ordering system for valve terminal VTUG

→ Internet: vtug

Manifold rail for in-line valves

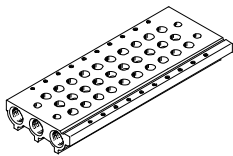

- For in-line valves M3, M5, M7, G $\frac{3}{8}$ and G $\frac{1}{4}$
- For 2x3/2-way, 5/2-way and 5/3-way valves
- 2 to 10 and 12, 14, 16 valve positions

Manifold rail for sub-base valves

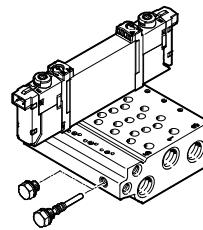

- For sub-base valves 10A, 10, 14 and 18
- Manifold rail with M5, M7, G $\frac{3}{8}$ and G $\frac{1}{4}$ working ports
- For 2x3/2-way, 5/2-way and 5/3-way valves
- 2 to 10, 12, 14 and 16 valve positions
- The sub-base valves always have external pilot air. The pilot air is set via the manifold rail. A short and a long blanking plug are included in the scope of delivery of the manifold rail for this purpose.

-  - Note

Pressurisation and exhaust at both ends is recommended for an optimised flow rate in cases where multiple valves switch simultaneously.

Blanking plate for vacant position



Vacant position cover

Supply plate



For additional air supply and exhaust via a valve position

Separator for pressure zones



For creating multiple pressure zones in a valve manifold

Solenoid valves VUVG

Key features – Pneumatic components

Vertical pressure supply plate

For semi in-line valves M5/M7 and G1/8

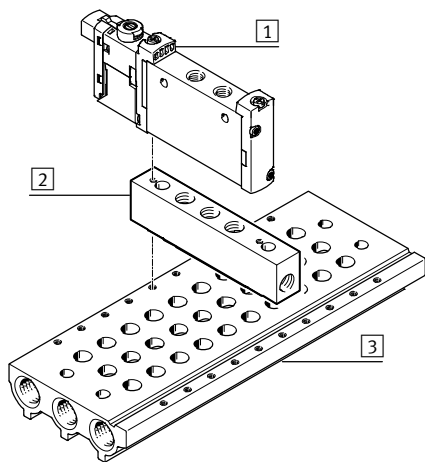

- 1 Semi in-line valve VUVG
- 2 Vertical pressure supply plate
- 3 Manifold rail

The vertical pressure supply plate enables the valve mounted on it to be pressurised and exhausted separately.
If two vertical pressure supply plates are mounted one on top of the other, the valve can be supplied with compressed air and exhausted completely independently of the valve terminal (terminal code CS).

Code	Type	For semi in-line valves		Description
		M5/M7	G1/8	
ZU	VABF-L1-P3A	■	■	Plate with port 1 for supplying an individual operating pressure or separate exhausting (reverse operation) for a valve position.
ZV	VABF-L1-P7A	■	■	Plate with ports 3 and 5 for exhausting the valve or supplying an individual operating pressure (reverse operation) for a valve position.

Flow control

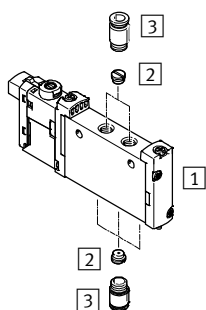

- 1 Valves VUVG with individual electrical connection
- 2 Flow control
- 3 Fitting

Semi in-line valve, individual electrical connection: flow control can be fitted in port 1, 3, 5 and/or in port 2, 4.

Sub-base valve, individual electrical connection: flow control can be fitted in port 2, 4.

Solenoid valves VUVG

Key features – Pneumatic components

Creating pressure zones and separating exhaust air

Compressed air is supplied and exhausted via the manifold rail and via supply plates.

The position of the supply plates and duct separations can be freely selected with the VUVG.

Pressure zones are created by isolating the internal supply ducts between the manifold sub-bases by means of appropriate duct separation.

Pressure zone separation can be used for the following ducts:

- Duct 1
- Duct 3
- Duct 5

Note

- Use a separator if the exhaust air pressures are high
- Use at least one supply plate/supply for each pressure zone
- Pressure zone separation is not possible in duct 12/14 (pilot air supply)

Duct separation	Description
	<p>The pressure zones can be freely configured with the VUVG. The following duct separations are possible:</p> <p>Duct 1 closed</p> <p>Duct 1, 3, 5 closed</p> <p>Duct 3, 5 closed</p>
	<p>The number of pressure zones with the VUVG is only limited by the number of valve positions on the manifold rail. Note that each supply plate occupies one valve position.</p>

Separator VABD

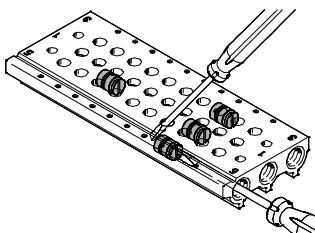

Note

As the separators are fitted from only one side using a slotted screwdriver, several pressure zones can be created in one profile.

Solenoid valves VUVG

Key features – Pneumatic components

Pilot air supply port

Internal pilot air supply

Internal pilot air supply can be chosen with an operating pressure in the range 1.5 ... 8 bar, 2.5 ... 8 bar or 3 ... 8 bar (depending on the valve used).

The pilot air supply is branched from duct 1 (compressed air supply) using an internal connection.

External pilot air supply

External pilot air supply is required for vacuum operation. The port for external pilot air supply (port 12/14) is located on the valve in the case of in-line valves and on the manifold rail in the case of sub-base valves.

Pilot exhaust air port

With in-line valves, the pilot exhaust air escapes via exhaust holes. With sub-base valves, the pilot air is exhausted via duct 82/84 of the manifold rail.

Pilot air supply with in-line and semi in-line valves

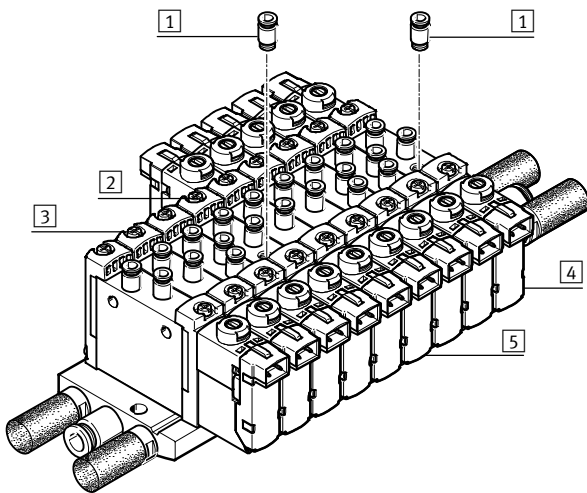

- 1 Push-in fitting for external pilot air supply at port 12/14
- 2 Single solenoid valve with external pilot air supply
- 3 Single solenoid valve with internal pilot air supply
- 4 Double solenoid valve with external pilot air supply
- 5 Double solenoid valve with internal pilot air supply

The internal pilot air is branched from port 1 in the valve body. The external pilot air (port 12/14) is supplied individually at each valve housing.

 Note
Semi in-line valves cannot be supplied centrally with pilot air via the manifold rail.

Pilot air supply with sub-base valves

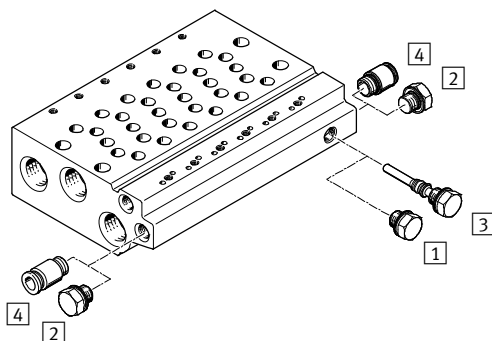

- 1 Short blanking plug with internal pilot air
- 2 Blanking plug for duct 12/14 with internal pilot air
- 3 Blanking plug, long, with external pilot air
- 4 Push-in fitting in duct 12/14 with external pilot air

The manifold rails for sub-base valves have an internal conduit between duct 12/14 and duct 1. Internal or external pilot air supply is selected by inserting a blanking plug into this conduit.

Solenoid valves VUVG

Key features – Pneumatic components

Operation with different pressures

Vacuum operation

Points to note with 3/2-way valves
The 3/2-way valves are available in a design with two valves in one valve body and with pneumatic spring return. With these valves, the force for the return movement is obtained from port 1.

Vacuum operation is therefore only possible at port 3 and 5, not at port 1.

With external pilot air supply, vacuum can be connected at port 1, 3, 5 of the 5/2-way and 5/3-way valves.

Reverse operation

The 3/2-way valves with pneumatic spring are not suitable for reverse operation, since at least the minimum pilot pressure must be present in duct 1.

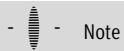

Note

Pressure must be present at port 1.

Pressure deflector (internal pilot air)

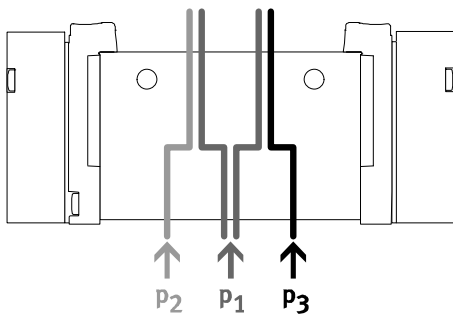

- If two different pressures are required.

- Different pressures can be supplied at duct 1, 3 and 5.



Note

- With internal pilot air supply, the minimum pilot pressure must be adhered to in duct 1

- With 2x3/2-way valves without spring return, the minimum pilot pressure must always be adhered to in duct 1

Benefits

Any pressure or vacuum can be connected at duct 3 and 5 both with external and internal pilot air

Vacuum, ejector pulse and normal position

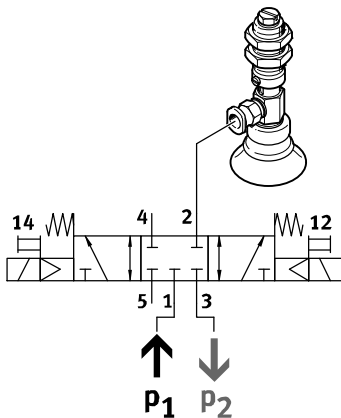

Vacuum, ejector pulse and normal position can be achieved as follows:

- Internal pilot air supply
- Vacuum in duct 3
- Pressure for the ejector pulse in duct 1

Solenoid valves VUVG

Product range overview

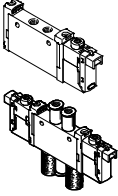
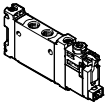
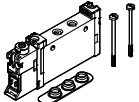
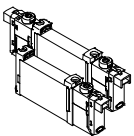
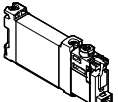
Design	Working port	Type Code	Functions and flow rate [l/min]												→ Page/ Internet
			T32C	T32U	T32H	T32C/M	T32U/M	T32H/M	M52	M52/M	B52	P53C	P53U	P53E	
In-line valve as individual valve, solenoid valve VUVG-L															
	M3	10A	-	-	-	-	-	-	100	80	100	90	90	90	18
	M5	10	■	■	■	■	■	■	■	■	■	■	■	■	30
	M7	10	150	150	150	135	125	125	220	190	220	210	210	210	38
	G1/8	14	■	■	■	■	■	■	■	■	■	■	■	■	49
	G1/4	18	■	■	■	■	■	■	■	■	■	■	■	■	57
In-line valve as individual valve, solenoid valve VUVG-LK															
	M5	10	■	-	-	-	-	-	■	-	■	-	-	-	26
	M7	10	180	-	-	-	-	-	■	-	■	-	-	-	34
	G1/8	14	■	-	-	-	-	-	■	-	■	-	-	-	46
In-line valve for manifold assembly, solenoid valve VUVG-S															
	M3	10A	-	-	-	-	-	-	100	80	100	90	90	90	18
	M5	10	■	■	■	■	■	■	■	■	■	■	■	■	30
	M7	10	150	150	150	135	125	125	220	190	220	210	210	210	38
	G1/8	14	■	■	■	■	■	■	■	■	■	■	■	■	49
	G1/4	18	■	■	■	■	■	■	■	■	■	■	■	■	57
Sub-base valve, solenoid valve VUVG-B															
	M5	10A	-	-	-	-	-	-	■	■	■	■	■	■	65
	M5	10	■	■	■	■	■	■	■	■	■	■	■	■	75
	M7	10	150	150	150	130	120	120	210	180	210	200	200	200	75
	G1/8	14	■	■	■	■	■	■	■	■	■	■	■	■	83
	G1/4	18	■	■	■	■	■	■	■	■	■	■	■	■	94
Sub-base valve, solenoid valve VUVG-BK															
	M5	10	■	-	-	-	-	-	■	-	■	-	-	-	72
	M7	10	160	-	-	-	-	-	■	-	■	-	-	-	72
	G1/8	14	■	-	-	-	-	-	■	-	■	-	-	-	83

Solenoid valves VUVG

Product range overview

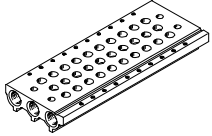
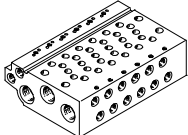
Design	Type code	Description	→ Page/ Internet
Manifold rail VABM- ... -S- ..., for in-line valves (manifold assembly)			
	10AS	Size M3	vabm
	10S	Size M5, M7	
	14S	Size G1/8	
	18S	Size G1/4	
Manifold rail VABM, for sub-base valves			
	10AW	Size M3	vabm
	10W	Size M5	
	10HW	Size M7	
	14W	Size G1/8	
	18W	Size G1/4	

Solenoid valves VUVG

Overview of valve functions

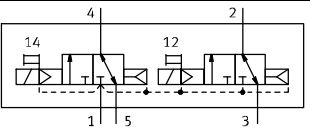
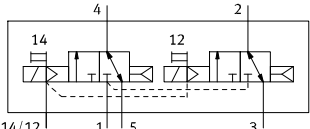
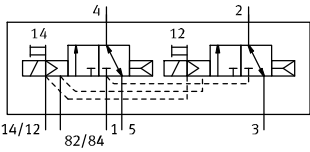
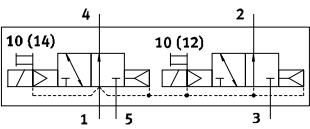
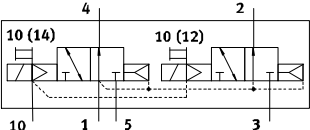
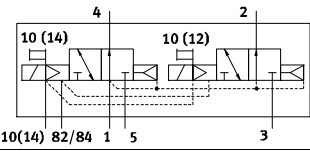
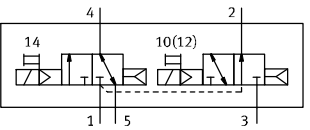
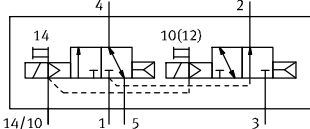
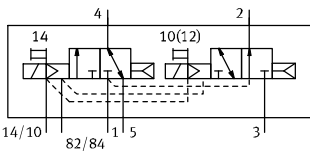
Valve	Valve code	Description	Order code ¹⁾	VUVG-L, VUVG-B				VUVG-LK, VUVG-BK	
				Size				Size	
				M3	M5/M7	G1/8	G1/4	M5/M7	G1/8
2x3/2-way valve, normally closed, pneumatic spring									
	T32C-A	In-line valve, internal pilot air supply	K	-	■	■	■	■	■
		In-line valve, external pilot air supply		-	■	■	■	-	-
		Sub-base valve, external pilot air supply		-	■	■	■	-	-
2x3/2-way valve, normally open, pneumatic spring									
	T32U-A	In-line valve, internal pilot air supply	N	-	■	■	■	-	-
		In-line valve, external pilot air supply		-	■	■	■	-	-
		Sub-base valve, external pilot air supply		-	■	■	■	-	-
2x3/2-way valve, 1x normally open, 1x normally closed, pneumatic spring									
	T32H-A	In-line valve, internal pilot air supply	H	-	■	■	■	-	-
		In-line valve, external pilot air supply		-	■	■	■	-	-
		Sub-base valve, external pilot air supply		-	■	■	■	-	-

1) Valve terminal/position function order code

New
VUVG-LK, VUVG-BK



Solenoid valves VUVG

Overview of valve functions

Valve	Valve code	Description	Order ¹⁾ code	VUVG-L, VUVG-B				VUVG-LK, VUVG-BK	
				Size				Size	
				M3	M5/M7	G1/8	G1/4	M5/M7	G1/8
2x3/2-way valve, normally closed, mechanical spring									
	T32C-M	In-line valve, internal pilot air supply	VK	-	■	■	■	-	-
		In-line valve, external pilot air supply		-	■	■	■	-	-
		Sub-base valve, external pilot air supply		-	■	■	■	-	-
2x3/2-way valve, normally open, mechanical spring									
	T32U-M	In-line valve, internal pilot air supply	VN	-	■	■	■	-	-
		In-line valve, external pilot air supply		-	■	■	■	-	-
		Sub-base valve, external pilot air supply		-	■	■	■	-	-
2x3/2-way valve, 1x normally open, 1x normally closed, mechanical spring									
	T32H-M	In-line valve, internal pilot air supply	VH	-	■	■	■	-	-
		In-line valve, external pilot air supply		-	■	■	■	-	-
		Sub-base valve, external pilot air supply		-	■	■	■	-	-

1) Valve terminal/position function order code

Solenoid valves VUVG

Overview of valve functions

Valve	Valve code	Description	Order code ¹⁾	VUVG-L, VUVG-B				VUVG-LK, VUVG-BK	
				Size				Size	
				M3	M5/M7	G1/8	G1/4	M5/M7	G1/8
5/2-way valve, double solenoid									
	B52	In-line valve, internal pilot air supply	J	■	■	■	■	■	■
		In-line valve, external pilot air supply		■	■	■	■	-	-
		Sub-base valve, external pilot air supply		■	■	■	■	-	-
5/2-way valve, single solenoid, pneumatic spring									
	M52-A	In-line valve, internal pilot air supply	M	-	-	■	-	■	■
		In-line valve, external pilot air supply		-	-	■	-	-	-
		Sub-base valve, external pilot air supply		-	-	■	-	-	-
5/2-way valve, single solenoid, mechanical spring									
	M52-M	In-line valve, internal pilot air supply	A	■	■	■	■	-	-
		In-line valve, external pilot air supply		■	■	■	■	-	-
		Sub-base valve, external pilot air supply		■	■	■	■	-	-
5/2-way valve, single solenoid, pneumatic/mechanical spring									
	M52-R	In-line valve, internal pilot air supply	P	■	■	-	■	-	-
		In-line valve, external pilot air supply		■	■	-	■	-	-
		Sub-base valve, external pilot air supply		■	■	-	■	-	-

1) Valve terminal/position function order code

New
VUVG-LK, VUVG-BK

FESTO

Solenoid valves VUVG

Overview of valve functions

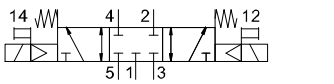
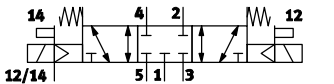
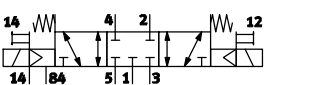
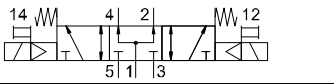
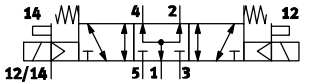
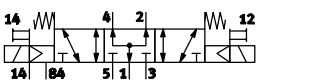
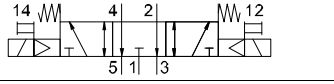
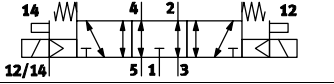
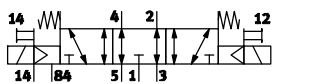
Valve	Valve code	Description	Order code ¹⁾	VUVG-L, VUVG-B				VUVG-LK, VUVG-BK	
				Size				Size	
				M3	M5/M7	G1/8	G1/4	M5/M7	G1/8
5/3-way valve, mid-position closed									
	P53C	In-line valve, internal pilot air supply	G	■	■	■	■	-	-
		In-line valve, external pilot air supply		■	■	■	■	-	-
		Sub-base valve, external pilot air supply		■	■	■	■	-	-
5/3-way valve, mid-position pressurised									
	P53U	In-line valve, internal pilot air supply	B	■	■	■	■	-	-
		In-line valve, external pilot air supply		■	■	■	■	-	-
		Sub-base valve, external pilot air supply		■	■	■	■	-	-
5/3-way valve, mid-position exhausted									
	P53E	In-line valve, internal pilot air supply	E	■	■	■	■	-	-
		In-line valve, external pilot air supply		■	■	■	■	-	-
		Sub-base valve, external pilot air supply		■	■	■	■	-	-

1) Valve terminal/position function order code

Solenoid valves VUVG

Sample system overview – In-line valves M5/M7

Manifold assembly

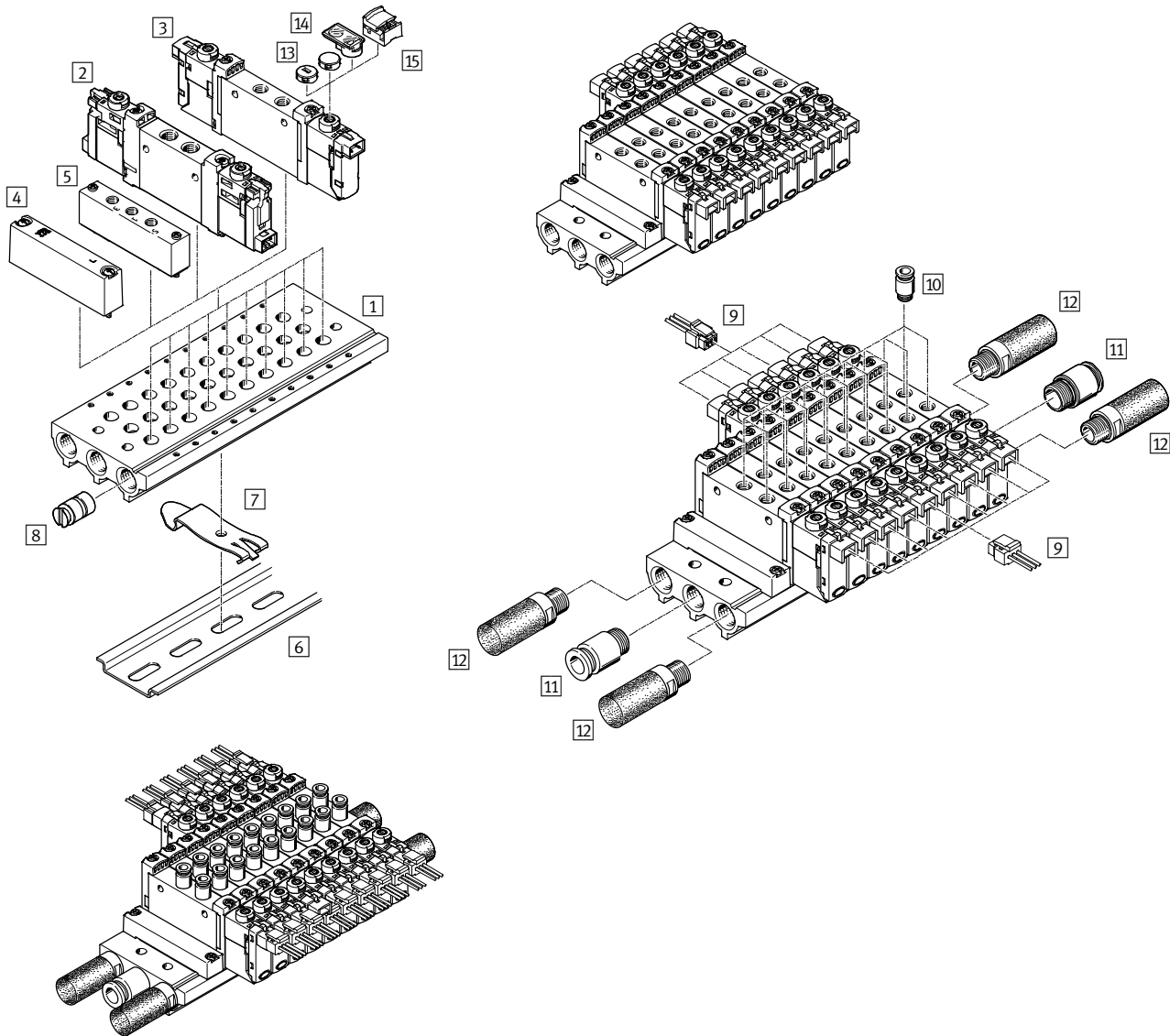

Manifold assembly and accessories

	Type	Brief description	→ Page/Internet	
1	Manifold rail	VABM-L1-10S-G18-...	For 2 to 10, 12, 14 and 16 valve positions	43
2	Solenoid valve	VUVG-LK ...	In-line valve 2x3/2-way, 5/2-way and 5/3-way	25
3	Solenoid valve	VUVG-L ...	In-line valve 2x3/2-way, 5/2-way and 5/3-way	25
4	Blanking plate	VABB-L1-10-S	For covering an unused valve position	43
5	Supply plate	VABF-L1-10-P3A4- ...	For air supply at duct 1 and duct 3 and 5	43
6	H-rail	NRH-35-2000	For mounting the valve manifold	107
7	H-rail mounting	VAME-T-M4	2 pieces for fitting the valve manifold on an H-rail	107
8	Separator	VABD-...	For creating pressure zones	43
9	Plug socket with cable	NEBV-H1G2-...-LE2	For electrical connection box H2 and H3	105
10	Push-in fitting	QS...	Push-in fitting for duct 2 and 4	106
11	Push-in fitting	QS...	Push-in fitting for air supply at duct 1	106
12	Silencer	U...	For duct 3 and 5	106
13	Cover cap	VMPA-HB...-B	For manual override	107
14	Inscription label holder	ASLR-D	For labelling the valves, covering the mounting screw and the manual override	107
15	Cover	VAMC	For manual override	107

Solenoid valves VUVG

Sample system overview, sub-base valves M5/M7



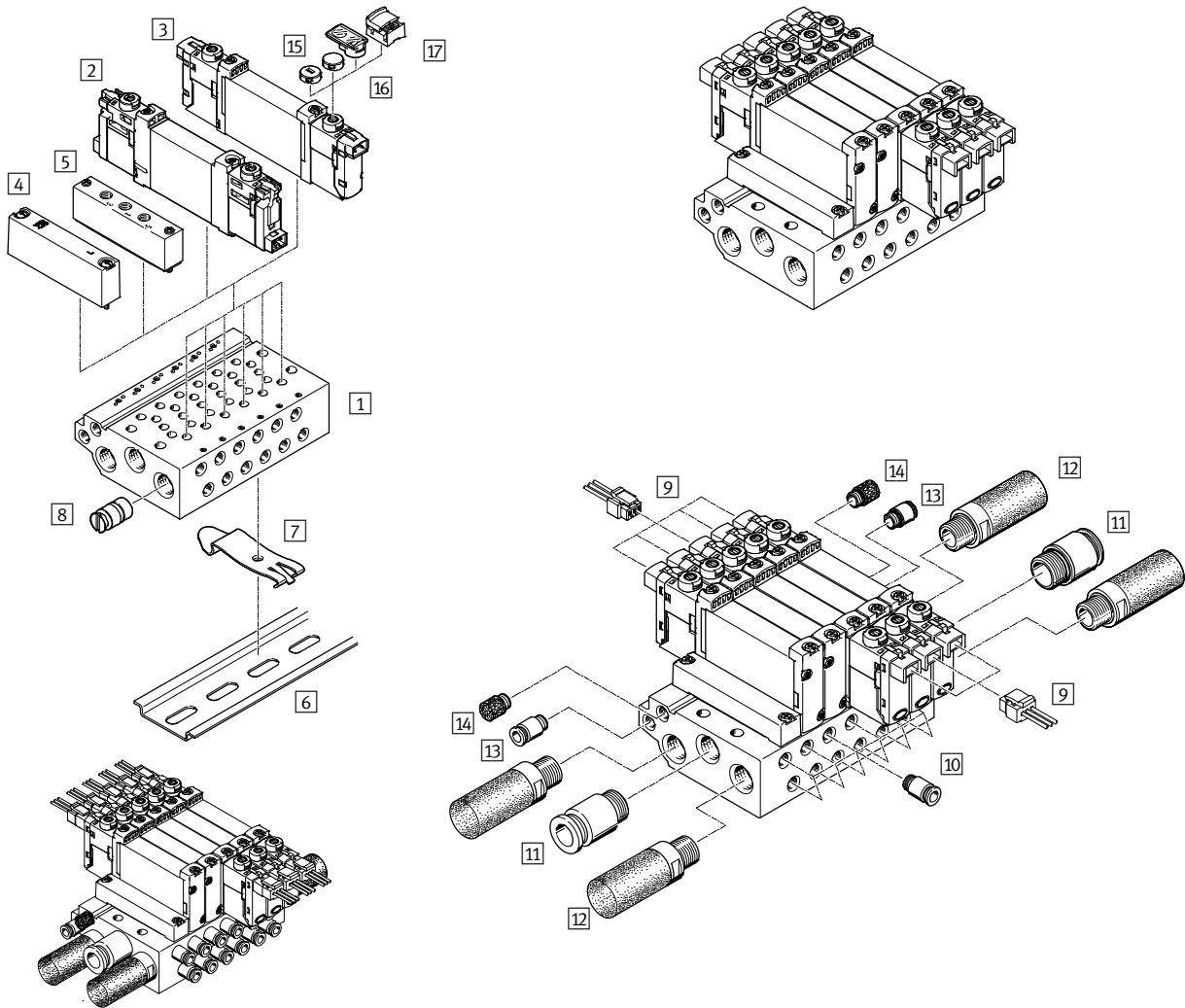

Manifold assembly

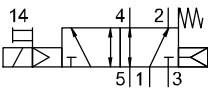
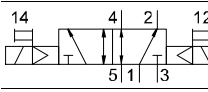
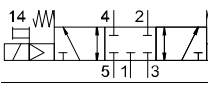
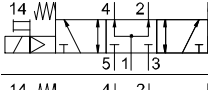
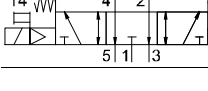

Manifold assembly and accessories		Type	Brief description	→ Page/Internet
1	Manifold rail	VABM-L1-10 ...-G18- ...	For 2 to 10, 12, 14 and 16 valve positions	80
2	Solenoid valve	VUVG-BK ...	Sub-base valve 2x3/2-way, 5/2-way and 5/3-way	71
3	Solenoid valve	VUVG-B ...	Sub-base valve 2x3/2-way, 5/2-way and 5/3-way	71
4	Blanking plate	VABB-L1-10-W	For covering an unused valve position	81
5	Supply plate	VABF-L1-10-P3A4- ...	For air supply at duct 1 and duct 3 and 5	81
6	H-rail	NRH-35-2000	For mounting the valve manifold	107
7	H-rail mounting	VAME-T-M4	2 pieces for fitting the valve manifold on an H-rail	107
8	Separator	VABD- ...	For creating pressure zones	81
9	Plug socket with cable	NEBV-H1G2-KN-...-LE2	For electrical connection box H2 and H3	105
10	Push-in fitting	QS...	Push-in fitting for duct 2 and 4	106
11	Push-in fitting	QS...	Push-in fitting for air supply at duct 1	106
12	Silencer	U...	For duct 3 and 5	106
13	Push-in fitting	QS...	Push-in fitting for pilot air supply at duct 12/14	106
14	Silencer	U...	Silencer for pilot air outlet at duct 82/84	106
15	Cover cap	VMPA-HB...-B	For manual override	107
16	Inscription label holder	ASLR-D	For labelling the valves, covering the mounting screw and the manual override	107
17	Cover	VAMC	For manual override	107

Solenoid valves VUVG, in-line valves M3

Order code

VUVG	-	10A	-	-	-	-
Valve type						
In-line, individual valve	L					
In-line valve, manifold valve incl. seal and screws	S					
Design principle						
Piston spool with sealing cartridge	-					
Valve size						
10 mm		10A				
Valve functions						
					M52	
					B52	
					P53C	
					P53U	
					P53E	
Reset method						
Mechanical spring with M52					M	
Pneumatic/mechanical spring with M52					R	
With B52 and P53					-	
Pilot air supply port						
Internal					-	
External					Z	
Manual override						
 Non-detenting					H	
 Covered					S	
- Non-detenting, detenting					T	
 Detenting, without accessories					Y	

					L	-
Connecting cables						
W1...4					Not	Sheathed
C1...4					Sheathed	
WS1...4					Not	Sheathed
S1...4					Sheathed	
N1...4					M8x1, 3-pin	
N5...8					M8x1, 4-pin	
Display						
L					LED	
Protective circuit						
-					Without holding current reduction (HCR)	
R					With holding current reduction (HCR)	
Electrical connection box						
H2					Connection pattern H, horizontal plug connector	
H3					Connection pattern H, vertical plug connector	
S2					Connection pattern S, horizontal plug connector	
S3					Connection pattern S, vertical plug connector	
L1...4					With 2x flying leads L: 1 = 0.5 m, 2 = 1 m, 3 = 2.5 m, 4 = 5 m	
K6...9					Cable: K6 = 0.5 m, K7 = 1 m, K8 = 2.5 m, K9 = 5 m	
R1					Individual plug connector M8, 4-pin	
R8					Individual plug connector M8, 3-pin	
P3					Without electrical connection box	
Operating voltage						
1					24 V DC	
5					12 V DC	
4					5 V DC	
Exhausting with VUVG-L						
QN					Push-in fitting	
U					Silencer	
-					M3 thread	
Pneumatic connection						
M3					M3 thread	
T18					Push-in connector 1/8"	
T532					Push-in connector 3/32"	
Q3					Push-in connector 3 mm/M3	
Q4					Push-in connector 4 mm/M3	

Solenoid valves VUVG-L10A and VUVG-S10A, in-line valves M3





Technical data

Function

5/2-way, single solenoid
5/2-way, double solenoid
5/3C, 5/3U, 5/3E

Circuit symbol → page 11

-  - Width 10 mm
-  - Flow rate
90 ... 100 l/min
-  - Voltage
5, 12 and 24 V DC

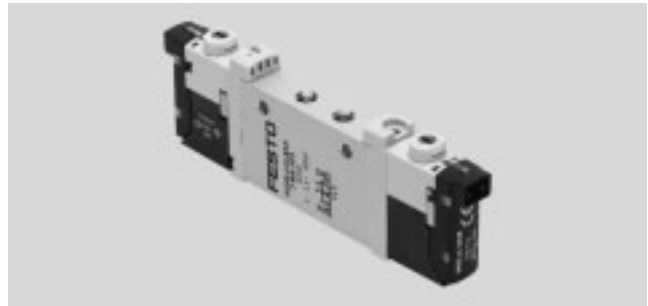

General technical data						
Valve function	M52-R	B52	M52-M	P53		
Normal position	–	–	–	C ¹⁾	U ²⁾	E ³⁾
Stable position	Single solenoid	Double solenoid	Single solenoid	Single solenoid		
Reset method: pneumatic spring	Yes ⁴⁾	–	No	No		
Reset method: mechanical spring	Yes ⁴⁾	–	Yes	Yes		
Vacuum operation at port 1	Only with external pilot air supply					
Design	Piston spool valve					
Sealing principle	Soft					
Actuation type	Electrical					
Type of control	Piloted					
Pilot air supply	Internal or external					
Exhaust function	With flow control					
Manual override	Choice of non-detenting, covered, non-detenting/detenting or detenting					
Type of mounting	Optionally via through-holes ⁵⁾ or on manifold rail					
Mounting position	Any					
Nominal size	[mm]	2	1.4	2		
Nominal flow rate	[l/min]	100	80	90		
Flow rate on manifold rail	[l/min]	100	80	90		
Switching time on/off	[ms]	7/15	–	7/21	8/25	
Changeover time	[ms]	–	5	–	14	
Width	[mm]	10				
Port	1, 2, 3, 4, 5; 12/14	M3				
Product weight	[g]	38	49	37		
Approval	c UL us - Recognized (OL) c CSA us (OL)					
CE marking (see declaration of conformity)	To EU EMC Directive ⁶⁾					
Corrosion resistance class CRC ⁷⁾	2					

1) C=Normally closed/mid-position closed

2) U=Normally open/mid-position pressurised

3) E=Mid-position exhausted

4) Combined reset method

5) If several valves are to be screwed together via the through-holes to form a block, a minimum distance of 0.3 mm must be ensured by placing spacer discs between them.

6) For information about the applicability of the component see the manufacturer's EC declaration of conformity at: www.festo.com/sp → Certificates.

If the component is subject to restrictions on usage in residential, office or commercial environments or small businesses, further measures to reduce the emitted interference may be necessary.

7) Corrosion resistance class 2 according to Festo standard 940 070

Components subject to moderate corrosion stress. Externally visible parts with primarily decorative surface requirements which are in direct contact with a normal industrial environment or media such as coolants or lubricating agents.

Solenoid valves VUVG-L10A and VUVG-S10A, in-line valves M3

Technical data

Operating and environmental conditions					
Valve function		M52-R ¹⁾	B52	M52-M ²⁾	P53
Operating medium		Compressed air in accordance with ISO 8573-2010 [7:4:4]			
Operating pressure	Internal	[bar]	2.5 ... 8	1.5 ... 8	3 ... 8
	External	[bar]	-0.9 ... 10		-0.9 ... 8
Pilot pressure ³⁾		[bar]	2.5 ... 8	1.5 ... 8	3 ... 8
Ambient temperature		[°C]	-5 ... +50, -5 ... +60 with holding current reduction		
Temperature of medium		[°C]	-5 ... +50, -5 ... +60 with holding current reduction		

1) Mixed, pneumatic/mechanical spring

2) Mechanical spring

3) Minimum pilot pressure 50% of operating pressure

Electrical data	
Electrical connection	Via E-box
Operating voltage	[V DC] 5, 12 and 24 ±10%
Power	[W] 1, reduced to 0.35 with holding current reduction
Duty cycle ED	[%] 100
Degree of protection to EN 60529	IP40 (with plug socket), IP65 (with M8)

Information on materials	
Housing	Wrought aluminium alloy
Seals	HNBR, NBR
Note on materials	RoHS compliant

Solenoid valves VUVG-L10A and VUVG-S10A, in-line valves M3

Technical data

Dimensions

Download CAD data → www.festo.com

5/2-way and 5/3-way valve

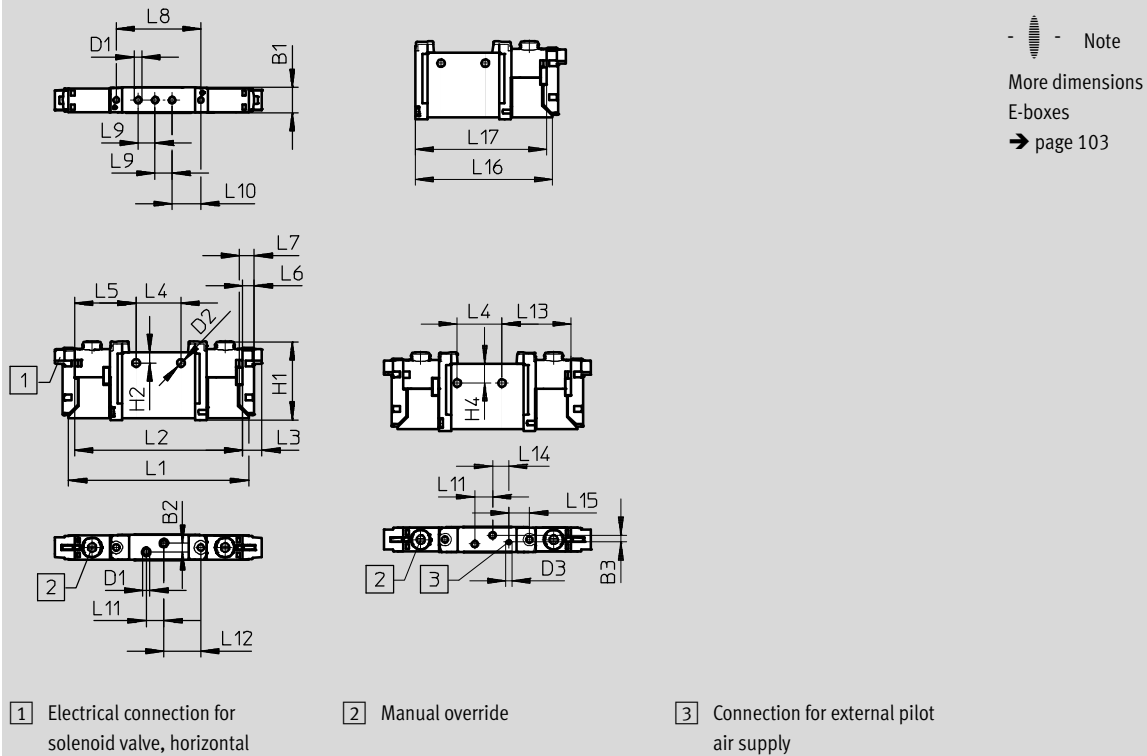

Type	B1	B2	B3	D1	D2	D3	H1	H2	L1	L2	L3	L4	L5
VUVG-L-10 -...-M3 ...	10.2	3.6	2.83	M3	3.2	M3	32.5	4.4	74.3	69.3	8	18.5	25.4
VUVG-S-10 -...-M3 ...													

Type	L6	L7	L8	L9	L10	L11	L12	L13	L14	L15	L16	L17
VUVG-L-10 -...-M3 ...	4.85	6.15	34.9	7	11.9	7.3	15.25	28.5	6.7	8.54	57.06	54.56
VUVG-S-10 -...-M3 ...												

Solenoid valves VUVG-L10A and VUVG-S10A, in-line valves M3

Ordering data

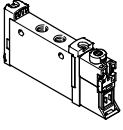
Ordering data				
	Description		Part No.	Type
In-line valve M3, without E-box				
	5/2-way valve, single solenoid			
	Internal pilot air supply	Reset method: pneumatic/mechanical spring	566437	VUVG-L10A-M52-RT-M3-1P3
		Reset method: mechanical spring	574345	VUVG-L10A-M52-MT-M3-1P3
	External pilot air supply	Reset method: pneumatic/mechanical spring	566443	VUVG-L10A-M52-RZT-M3-1P3
		Reset method: mechanical spring	574346	VUVG-L10A-M52-MZT-M3-1P3
	5/2-way valve, double solenoid			
	Internal pilot air supply		566438	VUVG-L10A-B52-T-M3-1P3
	External pilot air supply		566444	VUVG-L10A-B52-ZT-M3-1P3
	5/3-way valve			
	Internal pilot air supply	Mid-position closed	566439	VUVG-L10A-P53C-T-M3-1P3
		Mid-position exhausted	566440	VUVG-L10A-P53E-T-M3-1P3
		Mid-position pressurised	566441	VUVG-L10A-P53U-T-M3-1P3
	External pilot air supply	Mid-position closed	566445	VUVG-L10A-P53C-ZT-M3-1P3
		Mid-position exhausted	566446	VUVG-L10A-P53E-ZT-M3-1P3
Mid-position pressurised		566447	VUVG-L10A-P53U-ZT-M3-1P3	

Solenoid valves VUVG-S10A, in-line valves M3

Manifold assembly



In-line valves for manifold assembly



Dimensions

Download CAD data → www.festo.com

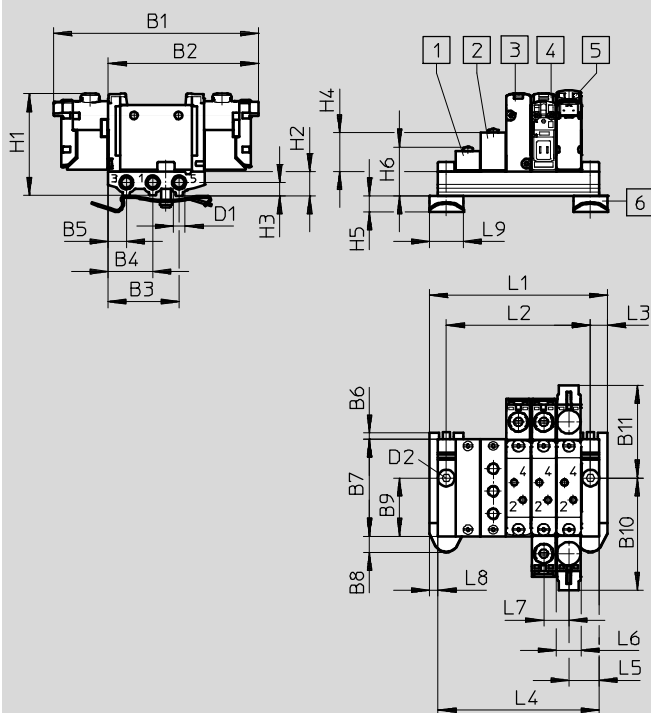

Note
More dimensions
E-boxes
→ page 103

- | | | |
|----------------------------------------|-------------------------------------------------------------|---------------------------------------------------------------------------|
| 1 Blanking plate | 4 Double solenoid valve, without E-box | 6 H-rail mounting (two M4x16 screws to DIN 912 are required for mounting) |
| 2 Supply plate | 5 Solenoid valve with E-box, vertical electrical connection | |
| 3 Single solenoid valve, without E-box | | |

Type	B1	B2	B3	B4	B5	B6	B7	B8	B9	B10	B11	D1
VUVG-S10A -...-M3 ...	85.3	62.6	29.7	18.7	7.7	3	40.3	6.8	24.2	46.7	38.6	M5

Type	D2	H1	H2	H3	H4	H5	H6	L3	L5	L6	L7	L8	L9
VUVG-S10A -...-M3 ...	∅ 4.5	43.8	10	5.5	16.2	6.8	20.3	7	12.5	10.3	10.5	3.5	14

Valve positions	2	3	4	5	6	7	8	9	10	12	14	16
L1 [mm]	42.5	53	63.5	74	84.5	95	105.5	116	126.5	147.5	168.5	189.5
L2 [mm]	28.5	39	49.5	60	70.5	81	91.5	102	112.5	133.5	154.5	175.5
L4 [mm]	35.5	46	56.5	67	77.5	88	98.5	109	119.5	140.5	161.5	182.5
VABM weight [g]	26	34	42	50	58	66	74	82	90	106	122	138

Solenoid valves VUVG-S10A, in-line valves M3

Ordering data

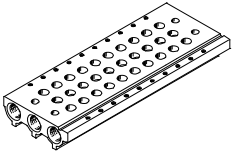
Technical data – Manifold rails							
	Port	CRC	Material ²⁾	Operating pressure [bar]	Max. tightening torque for assembly [Nm]		
	1, 3, 5				Valve	H-rail	Wall
	M5	2 ¹⁾	Wrought aluminium alloy	-0.9 ... 10	0.45	1.5	3

- 1) Corrosion resistance class 2 according to Festo standard 940070
Components subject to moderate corrosion stress. Externally visible parts with primarily decorative surface requirements which are in direct contact with a normal industrial environment or media such as coolants or lubricating agents.
- 2) Note on materials: RoHS-compliant.





Order code – Manifold rails

VABM	-	L1	-	10A	S	-	M5	-	
Valve manifold parts									Number of valve positions
Manifold rail		VABM							2 to 10, 12, 14 and 16
Valve series									Port 1, 3, 5
VUVG		L1					M5	M5 thread	
Valve width									
10 mm				10A					
Manifold rail with ports 1, 3, 5									
For M3 in-line valves					S				

Solenoid valves VUVG-S10A, in-line valves M3

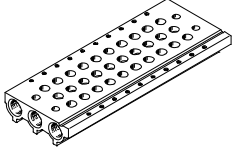
FESTO

Ordering data

Ordering data – Manifold rail			
	Description	Part No.	Type
Manifold rail for in-line valves (manifold assembly)			
	For valve size M3	2 valve positions	566522 VABM-L1-10AS-M5-2
		3 valve positions	566523 VABM-L1-10AS-M5-3
		4 valve positions	566524 VABM-L1-10AS-M5-4
		5 valve positions	566525 VABM-L1-10AS-M5-5
		6 valve positions	566526 VABM-L1-10AS-M5-6
		7 valve positions	566527 VABM-L1-10AS-M5-7
		8 valve positions	566528 VABM-L1-10AS-M5-8
		9 valve positions	566529 VABM-L1-10AS-M5-9
		10 valve positions	566530 VABM-L1-10AS-M5-10
		12 valve positions	566531 VABM-L1-10AS-M5-12
		14 valve positions	566532 VABM-L1-10AS-M5-14
16 valve positions	566533 VABM-L1-10AS-M5-16		
Blanking plate Technical data → Internet: vabb			
	For manifold rail for M3 in-line valves	Incl. screws and seal	569986 VABB-L1-10A
Separator Technical data → Internet: vabd			
	For manifold rail for M3 in-line valves	Separator for pressure zones	570872 VABD-4.2-B
Supply plate Technical data → Internet: vabf			
	For manifold rail for M3 in-line valves	Incl. screws and seal	569990 VABF-L1-10A-P3A4-M5
Seals for in-line valves Technical data → Internet: vabd			
	For M3 in-line valves	Delivery unit: 10 sets (each with 2 screws and 1 seal)	566670 VABD-L1-10AX-S-M3

Solenoid valves VUVG, in-line valves M5/M7

Order code

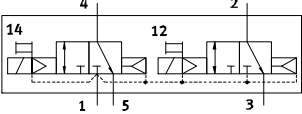
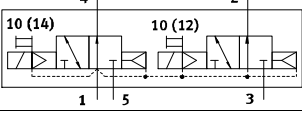
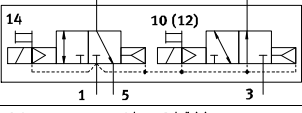
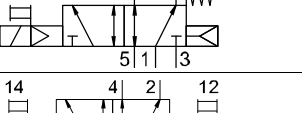
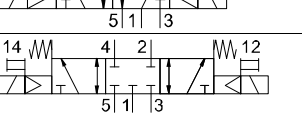
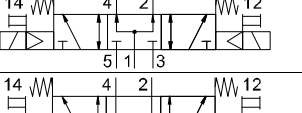
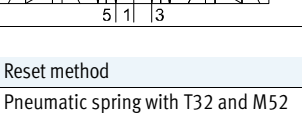
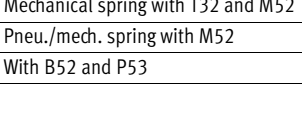
VUVG	-	10	-	-	-	-	-	-	-
Valve type									
In-line, individual valve		L							
In-line, manifold valve, including seal and screws		S							
Design principle									
Piston spool with sealing cartridge		-							
Piston spool with sealing ring		K							
Valve size									
10 mm		10							
Valve functions									
									T32C
									T32U
									T32H
									M52
									B52
									P53C
									P53U
									P53E
Reset method									
Pneumatic spring with T32 and M52									A
Mechanical spring with T32 and M52									M
Pneu./mech. spring with M52									R
With B52 and P53									-
Pilot air supply port									
Internal									-
External									Z
Manual override									
Non-detenting									H
Covered									S
Non-detenting, detenting									T
Detenting, without accessories									Y

									L	-	-	-	-	-	-	-	-	-	-
										Version									
										- Extended features									
										S Focused features									
										Connecting cables									
										W1...4 Not sheathed									
										C1...4 Sheathed									
										WS1...4 Not sheathed									
										S1...4 Sheathed									
										N1...4 M8x1, 3-pin									
										N5...8 M8x1, 4-pin									
										Display									
										L LED									
										Protective circuit									
										- Without holding current reduction (HCR)									
										R With holding current reduction (HCR)									
										Electrical connection box									
										H2 Connection pattern H, horiz. plug connector									
										H3 Connection pattern H, vert. plug connector									
										S2 Connection pattern S, horiz. plug connector									
										S3 Connection pattern S, vert. plug connector									
										L1...4 With 2x flying leads L: 1 = 0.5 m, 2 = 1 m, 3 = 2.5 m, 4 = 5 m									
										K6...9 Cable: K6 = 0.5 m, K7 = 1 m, K8 = 2.5 m, K9 = 5 m									
										R1 Individual plug connector M8, 4-pin									
										R8 Individual plug connector M8, 3-pin									
										P3 Without electrical connection box									
										Operating voltage									
										1 24 V DC									
										5 12 V DC									
										4 5 V DC									
										Exhausting with VUVG-L									
										QN Push-in fitting									
										U Silencer									
										- M5/M7 thread									
										Pneumatic connection									
										M5 M5 thread									
										M7 M7 thread									
										Q3 Push-in connector 3 mm/M5									
										Q4 Push-in connector 4 mm/M5									
										Q4H Push-in connector 4 mm/M7									
										Q6 Push-in connector 6 mm/M5									
										Q6H Push-in connector 6 mm/M7									
										T18 Push-in connector 1/8"									
										T532 Push-in connector 3/32"									
										T316 Push-in connector 3/16"									
										T316H Push-in connector 3/16", M7									
										T14 Push-in connector 1/4"									
										T14H Push-in connector 1/4", M7									

New
VUVG-LK, VUVG-BK

Solenoid valves VUVG-LK10, in-line valves M5

FESTO

Technical data

Function
2x3/2C
5/2-way, single solenoid
5/2-way, double solenoid

-  - Valve size 10 mm

-  - Flow rate
180 ... 195 l/min

-  - Voltage
24 V DC

Circuit symbol → page 11



General technical data VUVG-LK-M5			
Valve function	T32-A	M52-A	B52
Normal position	C ¹⁾	–	–
Stable positions	Monostable		Bistable
Reset method: pneumatic spring	Yes	Yes	–
Design	Piston spool		
Sealing principle	Soft		
Type of actuation	Electrical		
Type of piloting	Piloted		
Pilot air supply port	Internal		
Exhaust air function	With flow control		
Manual override	Detenting, non-detenting		
Type of mounting	Optionally via through-holes ²⁾ or on manifold rail		
Mounting position	Any		
Standard nominal flow rate	[l/min] 180	195	195
Switching time on/off	[ms] 12/14	14/17	–
Changeover time	[ms] –		7
Valve size	[mm] 10		
Port	2, 4	M5	
Product weight	[g] 55	45	57
Corrosion resistance class CRC ³⁾	2		

1) C=Normally closed.

2) If several valves are to be screwed together via the through-holes to form a block, a minimum distance of 0.3 mm must be ensured by placing spacer discs between them.

3) Corrosion resistance class 2 to Festo standard 940 070

Components subject to moderate corrosion stress. External visible parts with primarily decorative surface requirements which are in direct contact with the surrounding industrial environment or media such as coolants or lubricating agents.

Safety data	
Note on forced checking procedure	Switching frequency min. 1/week
Max. positive test pulse with 0 signal	[μs] 1600
Max. negative test pulse with 1 signal	[μs] 3000
Resistance to shocks	Shock test with severity level 1 to FN 942017-5 and EN 60068-2-27
Vibration resistance	Transport application test with severity level 1 to FN 942017-4 and EN 60068-2-6

Solenoid valves VUVG-LK10, in-line valves M5

Technical data

Operating and environmental conditions				
Valve function		T32-A ¹⁾	M52-A ¹⁾	B52
Operating medium		Compressed air in accordance with ISO 8573-2010 [7:4:4]		
Note on operating/pilot medium		Lubricated operation possible (in which case lubricated operation will always be required)		
Operating pressure	[bar]	1.5 ... 7	2.5 ... 7	1.5 ... 7
Ambient temperature	[°C]	-5 ... +50		
Temperature of medium	[°C]	-5 ... +50		

1) Pneumatic spring

Electrical data	
Electrical connection	Via connecting plate
Operating voltage	[V DC] 24 ±10%
Power	[W] 0.7
Duty cycle	[%] 100
Degree of protection to EN 60529	IP40 (with plug socket), IP65/IP67 (with M8)
Signal status display	LED
Maximum switching frequency	[Hz] 2

Information on materials	
Housing	Wrought aluminium alloy
Seals	HNBR, NBR
Note on materials	RoHS compliant
	Contains PWIS (paint-wetting impairment substances)

New
VUVG-LK, VUVG-BK

Solenoid valves VUVG-LK10, in-line valves M5

Technical data

FESTO

Dimensions

Download CAD data → www.festo.com

2x3/2-way, 5/2-way valve, double solenoid

5/2 way valve, single solenoid

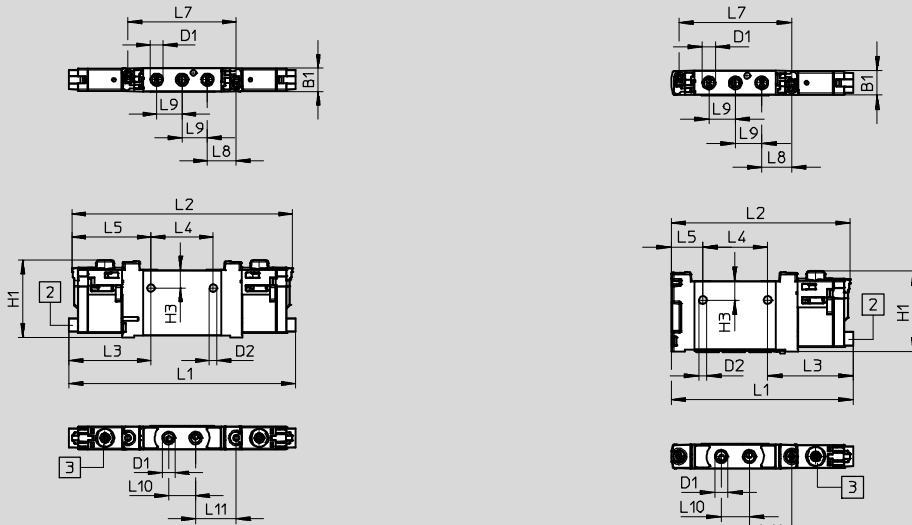

Note
 More dimensions for electrical connection boxes → page 103

2 Horizontal electrical connection 3 Manual override

Type	B1	D1	D2	H1	H3	L1	L2	L3	L4
VUVG-LK10-T32C-...-M5 ...	10.2	M5	3.3	33.6	7.8	98.3	95.8	35.7	27
VUVG-LK10-B52-...-M5 ...						75.9	74.6		
VUVG-LK10-M52-...-M5 ...									

Type	L5	L7	L8	L9	L10	L11
VUVG-LK10-T32C-...-M5 ...	34.4	47	12.5	11	11.7	17.7
VUVG-LK10-B52-...-M5 ...						
VUVG-LK10-M52-...-M5 ...	13.2					

Solenoid valves VUVG-LK10, in-line valves M5

Ordering data

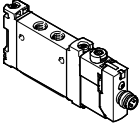
Ordering data			
	Description	Part No.	Type
In-line valve M5, with electrical connection box R8			
	2x3/2-way valve		
	Internal pilot air supply	Normally closed, reset method: pneumatic spring	8042542 VUVG-LK10-T32C-AT-M5-1R8L-S
	5/2-way valve, single solenoid		
	Internal pilot air supply	Reset method: pneumatic spring	8042543 VUVG-LK10-M52-AT-M5-1R8L-S
	5/2-way valve, double solenoid		
	Internal pilot air supply		8042544 VUVG-LK10-B52-T-M5-1R8L-S

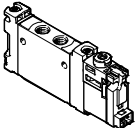
Ordering data			
	Description	Part No.	Type
In-line valve M5, with electrical connection box H2			
	2x3/2-way valve		
	Internal pilot air supply	Normally closed, reset method: pneumatic spring	8042538 VUVG-LK10-T32C-AT-M5-1H2L-S
	5/2-way valve, single solenoid		
	Internal pilot air supply	Reset method: pneumatic spring	8042539 VUVG-LK10-M52-AT-M5-1H2L-S
	5/2-way valve, double solenoid		
	Internal pilot air supply		8042540 VUVG-LK10-B52-T-M5-1H2L-S

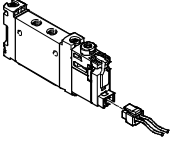
Ordering data			
	Description	Part No.	Type
In-line valve M5, with electrical connection box H2, connecting cable 0.5 m			
	2x3/2-way valve		
	Internal pilot air supply	Normally closed, reset method: pneumatic spring	589280 VUVG-LK10-T32C-AT-M5-1H2L-W1-S
	5/2-way valve, single solenoid		
	Internal pilot air supply	Reset method: pneumatic spring	589281 VUVG-LK10-M52-AT-M5-1H2L-W1-S
	5/2-way valve, double solenoid		
	Internal pilot air supply		589282 VUVG-LK10-B52-T-M5-1H2L-W1-S

Solenoid valves VUVG-L10 and VUVG-S10, in-line valves M5





Technical data

Function

2x3/2C, 2x3/2U, 2x3/2H
 5/2-way, single solenoid
 5/2-way, double solenoid
 5/3C, 5/3U, 5/3E

Circuit symbol → page 11

-  - Width 10 mm
-  - Flow rate
125 ... 220 l/min
-  - Voltage
5, 12 and 24 V DC

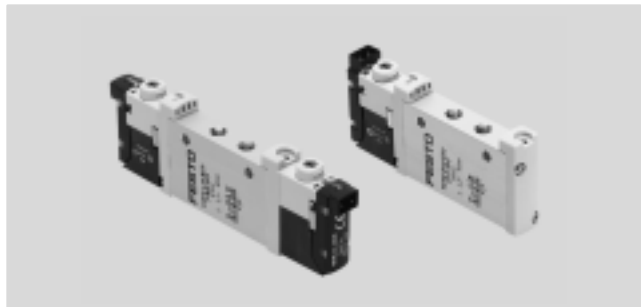

General technical data										
Valve function	T32-A			T32-M			M52-R	B52	M52-M	P53
Normal position	C ¹⁾	U ²⁾	H ⁴⁾	C ¹⁾	U ²⁾	H ⁴⁾	-	-	-	C ¹⁾ U ²⁾ E ³⁾
Stable position	Single solenoid							Double solenoid	Single solenoid	Single solenoid
Reset method: pneumatic spring	Yes			No			Yes ⁵⁾	-	No	No
Reset method: mechanical spring	No			Yes			Yes ⁵⁾	-	Yes	Yes
Vacuum operation at port 1	No			Only with external pilot air supply						
Design	Piston spool valve									
Sealing principle	Soft									
Actuation type	Electrical									
Type of control	Piloted									
Pilot air supply	Internal or external									
Exhaust function	With flow control									
Manual override	Choice of non-detenting, covered, non-detenting/detenting or detenting									
Type of mounting	Optionally via through-holes ⁶⁾ or on manifold rail									
Mounting position	Any									
Nominal size [mm]	2.7	1.9	1.8	3.2	2.2	3.2				
Nominal flow rate [l/min]	150	135	125	125	220	190	210			
Flow rate on manifold rail [l/min]	150	135	125	125	220	190	210			
Switching time on/off [ms]	6/16		8/11			7/19	-	8/24	10/30	
Changeover time [ms]	-							7	-	16
Width [mm]	10									
Port	1, 2, 3, 4, 5			M5						
	12/14			M3						
Product weight [g]	55			54			45	55	44	55
Approval	c UL us - Recognized(OL)									
	c CSA us (OL)									
CE marking (see declaration of conformity)	To EU EMC Directive ⁷⁾									
Corrosion resistance class CRC ⁸⁾	2									

1) C=Normally closed/mid-position closed

2) U=Normally open/mid-position pressurised

3) E=Mid-position exhausted

4) H=2x 3/2-way valve in one housing with 1x normally closed and 1x normally open

5) Combined reset method

6) If several valves are to be screwed together via the through-holes to form a block, a minimum distance of 0.3 mm must be ensured by placing spacer discs between them.

7) For information about the applicability of the component see the manufacturer's EC declaration of conformity at: www.festo.com/sp → Certificates.

If the component is subject to restrictions on usage in residential, office or commercial environments or small businesses, further measures to reduce the emitted interference may be necessary.

8) Corrosion resistance class 2 according to Festo standard 940 070

Components subject to moderate corrosion stress. Externally visible parts with primarily decorative surface requirements which are in direct contact with a normal industrial environment or media such as coolants or lubricating agents.

Solenoid valves VUVG-L10 and VUVG-S10, in-line valves M5

Technical data

Operating and environmental conditions								
Valve function			T32-A ¹⁾	T32-M ³⁾	M52-R ²⁾	B52	M52-M ³⁾	P53
Operating medium		Compressed air in accordance with ISO 8573-2010 [7:4:4]						
Operating pressure	Internal	[bar]	1.5 ... 8	2.5 ... 8	2.5 ... 8	1.5 ... 8	3 ... 8	3 ... 8
	External	[bar]	1.5 ... 10	-0.9 ... 10			-0.9 ... 8	-0.9 ... 10
Pilot pressure ⁴⁾		[bar]	1.5 ... 8	2 ... 8	2.5 ... 8	1.5 ... 8	3 ... 8	
Ambient temperature		[°C]	-5 ... +50, -5 ... +60 with holding current reduction					
Temperature of medium		[°C]	-5 ... +50, -5 ... +60 with holding current reduction					

- 1) Pneumatic spring
- 2) Mixed, pneumatic/mechanical spring
- 3) Mechanical spring
- 4) Minimum pilot pressure 50% of operating pressure

Electrical data	
Electrical connection	Via E-box
Operating voltage	[V DC] 5, 12 and 24 ±10%
Power	[W] 1, reduced to 0.35 with holding current reduction
Duty cycle ED	[%] 100
Degree of protection to EN 60529	IP40 (with plug socket), IP65 (with M8)

Information on materials	
Housing	Wrought aluminium alloy
Seals	HNBR, NBR
Note on materials	RoHS compliant

Dimensions Download CAD data → www.festo.com

2x3/2-way, 5/2-way and 5/3-way valve

⌀ - Note
More dimensions
E-boxes
→ page 103

1 Vertical electrical connection

2 Horizontal electrical connection

3 Manual override

4 Port for external pilot air supply

Type	B1	B2	D1	D2	D3	H1	H2	H3	L1	L2	L3	L4
VUVG-L-10 ...-M5 ...	10.2	-	M5	3.2	M3	32.5	3.6	4.4	86.5	81.5	8	27
VUVG-S-10 ...-M5 ...												

Type	L5	L6	L7	L8	L9	L10	L11	L12	L13	L14
VUVG-L-10 ...-M5 ...	4.85	6.15	47	14	11	12	19	-	69.2	66.7
VUVG-S-10 ...-M5 ...										

Solenoid valves VUVG-L10 and VUVG-S10, in-line valves M5

FESTO

Ordering data

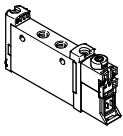
Ordering data					
Description		Part No.	Type		
In-line valve M5, without E-box					
	2x3/2-way valve				
	Internal pilot air supply	Normally closed, reset method: pneumatic spring	566454	VUVG-L10-T32C-AT-M5-1P3	
		Normally open, reset method: pneumatic spring	566455	VUVG-L10-T32U-AT-M5-1P3	
		1x normally open, 1x normally closed, reset method: pneumatic spring	566456	VUVG-L10-T32H-AT-M5-1P3	
		Normally closed, reset method: mechanical spring	574348	VUVG-L10-T32C-MT-M5-1P3	
		Normally open, reset method: mechanical spring	574349	VUVG-L10-T32U-MT-M5-1P3	
		1x normally open, 1x normally closed, reset method: mechanical spring	574350	VUVG-L10-T32H-MT-M5-1P3	
	External pilot air supply	Normally closed, reset method: pneumatic spring	566463	VUVG-L10-T32C-AZT-M5-1P3	
		Normally open, reset method: pneumatic spring	566464	VUVG-L10-T32U-AZT-M5-1P3	
		1x normally open, 1x normally closed, reset method: pneumatic spring	566465	VUVG-L10-T32H-AZT-M5-1P3	
		Normally closed, reset method: mechanical spring	574352	VUVG-L10-T32C-MZT-M5-1P3	
		Normally open, reset method: mechanical spring	574353	VUVG-L10-T32U-MZT-M5-1P3	
		1x normally open, 1x normally closed, reset method: mechanical spring	574354	VUVG-L10-T32H-MZT-M5-1P3	
	5/2-way valve, single solenoid				
	Internal pilot air supply	Reset method: pneumatic/mechanical spring	566457	VUVG-L10-M52-RT-M5-1P3	
		Reset method: mechanical spring	574351	VUVG-L10-M52-MT-M5-1P3	
	External pilot air supply	Reset method: pneumatic/mechanical spring	566466	VUVG-L10-M52-RZT-M5-1P3	
		Reset method: mechanical spring	574355	VUVG-L10-M52-MZT-M5-1P3	
	5/2-way valve, double solenoid				
	Internal pilot air supply		566458	VUVG-L10-B52-T-M5-1P3	
	External pilot air supply		566467	VUVG-L10-B52-ZT-M5-1P3	
5/3-way valve					
Internal pilot air supply	Mid-position closed	566459	VUVG-L10-P53C-T-M5-1P3		
	Mid-position exhausted	566460	VUVG-L10-P53E-T-M5-1P3		
	Mid-position pressurised	566461	VUVG-L10-P53U-T-M5-1P3		
External pilot air supply	Mid-position closed	566468	VUVG-L10-P53C-ZT-M5-1P3		
	Mid-position exhausted	566469	VUVG-L10-P53E-ZT-M5-1P3		
	Mid-position pressurised	566470	VUVG-L10-P53U-ZT-M5-1P3		

Solenoid valves VUVG-L10 and VUVG-S10, in-line valves M5

Ordering data

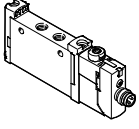
Ordering data					
	Description		Part No.	Type	
In-line valve M5, with E-box R8					
	2x3/2-way valve				
	Internal pilot air supply	Normally closed, reset method: pneumatic spring	577347	VUVG-L10-T32C-AT-M5-1R8L	
		Normally open, reset method: pneumatic spring	8031466	VUVG-L10-T32U-AT-M5-1R8L	
		1x normally open, 1x normally closed, reset method: pneumatic spring	8031467	VUVG-L10-T32H-AT-M5-1R8L	
		Normally closed, reset method: mechanical spring	8031468	VUVG-L10-T32C-MT-M5-1R8L	
		Normally open, reset method: mechanical spring	8031469	VUVG-L10-T32U-MT-M5-1R8L	
		1x normally open, 1x normally closed, reset method: mechanical spring	8031470	VUVG-L10-T32H-MT-M5-1R8L	
	5/2-way valve, single solenoid				
	Internal pilot air supply	Reset method: pneumatic/mechanical spring	572634	VUVG-L10-M52-RT-M5-1R8L	
		Reset method: mechanical spring	8031472	VUVG-L10-M52-MT-M5-1R8L	
	5/2-way valve, double solenoid				
	Internal pilot air supply		576664	VUVG-L10-B52-T-M5-1R8L	
5/3-way valve					
Internal pilot air supply	Mid-position closed	577346	VUVG-L10-P53C-T-M5-1R8L		
	Mid-position exhausted	8031475	VUVG-L10-P53E-T-M5-1R8L		
	Mid-position pressurised	8031476	VUVG-L10-P53U-T-M5-1R8L		

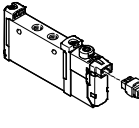
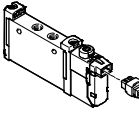
Ordering data					
	Description		Part No.	Type	
In-line valve M5, with E-box H2					
	2x3/2-way valve				
	Internal pilot air supply	Normally closed, reset method: pneumatic spring	578160	VUVG-L10-T32C-AT-M5-1H2L-W1	
		5/2-way valve, single solenoid			
	Internal pilot air supply	Reset method: pneumatic/mechanical spring	577316	VUVG-L10-M52-RT-M5-1H2L-W1	
		Reset method: mechanical spring	578162	VUVG-L10-M52-MT-M5-1H2L-W1	
	5/2-way valve, double solenoid				
	Internal pilot air supply		577317	VUVG-L10-B52-T-M5-1H2L-W1	
	5/3-way valve				
	Internal pilot air supply	Mid-position closed	577318	VUVG-L10-P53C-T-M5-1H2L-W1	
	In-line valve for manifold assembly M5, with E-box H2				
	2x3/2-way valve				
	Internal pilot air supply	Normally closed, reset method: pneumatic spring	577329	VUVG-S10-T32C-AT-M5-1H2L-W1	
		5/2-way valve, single solenoid			
	Internal pilot air supply	Reset method: pneumatic/mechanical spring	577324	VUVG-S10-M52-RT-M5-1H2L-W1	
		5/2-way valve, double solenoid			
Internal pilot air supply		577327	VUVG-S10-B52-T-M5-1H2L-W1		

New
VUVG-LK, VUVG-BK

Solenoid valves VUVG-LK10, in-line valves M7



FESTO

Technical data

Function
2x3/2C

5/2-way, single solenoid
5/2-way, double solenoid

Circuit symbol → page 11

-  - Valve size 10 mm
-  - Flow rate
280 ... 340 l/min
-  - Voltage
24 V DC



General technical data VUVG-LK M7			
Valve function	T32-A	M52-A	B52
Normal position	C ¹⁾	–	–
Stable positions	Monostable		Bistable
Reset method: pneumatic spring	Yes	Yes	–
Design	Piston spool		
Sealing principle	Soft		
Type of actuation	Electrical		
Type of piloting	Piloted		
Pilot air supply port	Internal		
Exhaust air function	With flow control		
Manual override	Detenting, non-detenting		
Type of mounting	Optionally via through-holes ³⁾ or on manifold rail		
Mounting position	Any		
Standard nominal flow rate	[l/min] 280	340	340
Switching time on/off	[ms] 12/14	14/17	–
Changeover time	[ms] –		7
Valve size	[mm] 10		
Port	2, 4	M7	
Product weight	[g] 55	45	57
Corrosion resistance class CRC ⁴⁾	2		

1) C=Normally closed.

2) If several valves are to be screwed together via the through-holes to form a block, a minimum distance of 0.3 mm must be ensured by placing spacer discs between them.

3) Corrosion resistance class 2 to Festo standard 940 070

Components subject to moderate corrosion stress. External visible parts with primarily decorative surface requirements which are in direct contact with the surrounding industrial environment or media such as coolants or lubricating agents.

Safety data	
Note on forced checking procedure	Switching frequency min. 1/week
Max. positive test pulse with 0 signal	[μs] 1600
Max. negative test pulse with 1 signal	[μs] 3000
Resistance to shocks	Shock test with severity level 1 to FN 942017-5 and EN 60068-2-27
Vibration resistance	Transport application test with severity level 1 to FN 942017-4 and EN 60068-2-6

Solenoid valves VUVG-LK10, in-line valves M7

Technical data

Operating and environmental conditions				
Valve function		T32-A ¹⁾	M52-A ¹⁾	B52
Operating medium		Compressed air in accordance with ISO 8573-2010 [7:4:4]		
Note on operating/pilot medium		Lubricated operation possible (in which case lubricated operation will always be required)		
Operating pressure	[bar]	1.5 ... 7	2.5 ... 7	1.5 ... 7
Ambient temperature	[°C]	-5 ... +50		
Temperature of medium	[°C]	-5 ... +50		

1) Pneumatic spring

Electrical data	
Electrical connection	Via electrical connection box
Operating voltage	[V DC] 24 ±10%
Power	[W] 0.7
Duty cycle	[%] 100
Degree of protection to EN 60529	IP40 (with plug socket), IP65/IP67 (with M8)
Signal status display	LED
Maximum switching frequency	[Hz] 2

Information on materials	
Housing	Wrought aluminium alloy
Seals	HNBR, NBR
Note on materials	RoHS compliant
	Contains PWIS (paint-wetting impairment substances)

New
VUVG-LK, VUVG-BK

Solenoid valves VUVG-LK10, in-line valves M7

Technical data

FESTO

Dimensions

Download CAD data → www.festo.com

2x3/2-way, 5/2-way valve, double solenoid

5/2 way valve, single solenoid

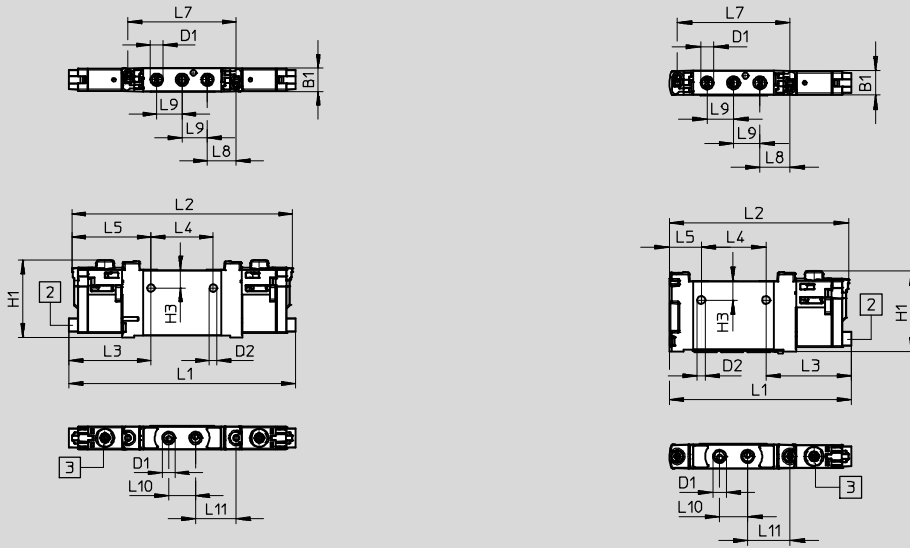

Note
More dimensions for electrical connection boxes → page 103

2 Horizontal electrical connection 3 Manual override

Type	B1	D1	D2	H1	H3	L1	L2	L3	L4
VUVG-LK10-T32C-...-M7 ...	10.2	M7	3.3	33.6	7.8	98.3	95.8	35.7	27
VUVG-LK10-B52-...-M7 ...						75.9	74.6	35.7	27
VUVG-LK10-M52-...-M7 ...									

Type	L5	L7	L8	L9	L10	L11
VUVG-LK10-T32C-...-M7 ...	34.4	47	12.5	11	11.7	17.7
VUVG-LK10-B52-...-M7 ...						
VUVG-LK10-M52-...-M7 ...	13.2					

Solenoid valves VUVG-LK10, in-line valves M7

Ordering data

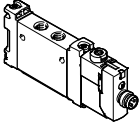
Ordering data			
	Description	Part No.	Type
In-line valve M7, with electrical connection box R8			
	2x3/2-way valve		
	Internal pilot air supply	Normally closed, reset method: pneumatic spring	8042550 VUVG-LK10-T32C-AT-M7-1R8L-S
	5/2-way valve, single solenoid		
	Internal pilot air supply	Reset method: pneumatic spring	8042551 VUVG-LK10-M52-AT-M7-1R8L-S
	5/2-way valve, double solenoid		
	Internal pilot air supply		8042552 VUVG-LK10-B52-T-M7-1R8L-S

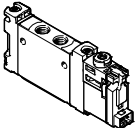
Ordering data			
	Description	Part No.	Type
In-line valve M7, with electrical connection box H2			
	2x3/2-way valve		
	Internal pilot air supply	Normally closed, reset method: pneumatic spring	8042546 VUVG-LK10-T32C-AT-M7-1H2L-S
	5/2-way valve, single solenoid		
	Internal pilot air supply	Reset method: pneumatic spring	8042547 VUVG-LK10-M52-AT-M7-1H2L-S
	5/2-way valve, double solenoid		
	Internal pilot air supply		8042548 VUVG-LK10-B52-T-M7-1H2L-S

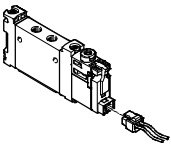
Ordering data			
	Description	Part No.	Type
In-line valve M7, with electrical connection box H2, connecting cable 0.5 m			
	2x3/2-way valve		
	Internal pilot air supply	Normally closed, reset method: pneumatic spring	589283 VUVG-LK10-T32C-AT-M7-1H2L-W1-S
	5/2-way valve, single solenoid		
	Internal pilot air supply	Reset method: pneumatic spring	589284 VUVG-LK10-M52-AT-M7-1H2L-W1-S
	5/2-way valve, double solenoid		
	Internal pilot air supply		589285 VUVG-LK10-B52-T-M7-1H2L-W1-S

Solenoid valves VUVG-L10 and VUVG-S10, in-line valves M7



Technical data

Function

2x3/2C, 2x3/2U, 2x3/2H

5/2-way, single solenoid

5/2-way, double solenoid

5/3C, 5/3U, 5/3E

Circuit symbol → page 11

-  - Width 10 mm

-  - Flow rate
170 ... 340 l/min

-  - Voltage
5, 12 and 24 V DC

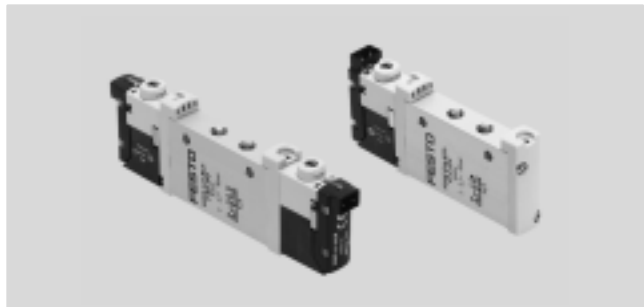

General technical data												
Valve function	T32-A			T32-M			M52-R	B52	M52-M	P53		
Normal position	C ¹⁾	U ²⁾	H ⁴⁾	C ¹⁾	U ²⁾	H ⁴⁾	-	-	-	C ¹⁾	U ²⁾	E ³⁾
Stable position	Single solenoid							Double solenoid	Single solenoid	Single solenoid		
Reset method: pneumatic spring	Yes			No			Yes ⁵⁾	-	No	No		
Reset method: mechanical spring	No			Yes			Yes ⁵⁾	-	Yes	Yes		
Vacuum operation at port 1	No			Only with external pilot air supply								
Design	Piston spool valve											
Sealing principle	Soft											
Actuation type	Electrical											
Type of control	Piloted											
Pilot air supply	Internal or external											
Exhaust function	With flow control											
Manual override	Choice of non-detenting, covered, non-detenting/detenting or detenting											
Type of mounting	Optionally via through-holes ⁶⁾ or on manifold rail											
Mounting position	Any											
Nominal size [mm]	2.7			2.0	1.9	1.9	4.0	2.8		3.5		
Nominal flow rate [l/min]	190			150	140	140	380	320		320		
Flow rate on manifold rail [l/min]	170			140	130	130	340	290		300		
Switching time on/off [ms]	6/16			8/11			7/19	-	8/24	10/30		
Changeover time [ms]	-			-			-	7	-		16	
Width [mm]	10											
Port	1, 2, 3, 4, 5			M7								
	12/14			M3								
Product weight [g]	55			54			45	55	44	55		
Approval	c UL us - Recognized (OL)											
	c CSA us (OL)											
CE marking (see declaration of conformity)	To EU EMC Directive ⁷⁾											
Corrosion resistance class CRC ⁸⁾	2											

1) C=Normally closed/mid-position closed

2) U=Normally open/mid-position pressurised

3) E=Mid-position exhausted

4) H=2x 3/2-way valve in one housing with 1x normally closed and 1x normally open

5) Combined reset method

6) If several valves are to be screwed together via the through-holes to form a block, a minimum distance of 0.3 mm must be ensured by placing spacer discs between them.

7) For information about the applicability of the component see the manufacturer's EC declaration of conformity at: www.festo.com/sp → Certificates.

If the component is subject to restrictions on usage in residential, office or commercial environments or small businesses, further measures to reduce the emitted interference may be necessary.

8) Corrosion resistance class 2 according to Festo standard 940 070

Components subject to moderate corrosion stress. Externally visible parts with primarily decorative surface requirements which are in direct contact with a normal industrial environment or media such as coolants or lubricating agents.

Solenoid valves VUVG-L10 and VUVG-S10, in-line valves M7

Technical data

Operating and environmental conditions								
Valve function			T32-A ¹⁾	T32-M ³⁾	M52-R ²⁾	B52	M52-M ³⁾	P53
Operating medium		Compressed air in accordance with ISO 8573-2010 [7:4:4]						
Operating pressure	Internal	[bar]	1.5 ... 8	2.5 ... 8	2.5 ... 8	1.5 ... 8	3 ... 8	
	External	[bar]	1.5 ... 10	-0.9 ... 10			-0.9 ... 8	-0.9 ... 10
Pilot pressure ⁴⁾		[bar]	1.5 ... 8	2 ... 8	2.5 ... 8	1.5 ... 8	3 ... 8	3 ... 8
Ambient temperature		[°C]	-5 ... +50, -5 ... +60 with holding current reduction					
Temperature of medium		[°C]	-5 ... +50, -5 ... +60 with holding current reduction					

- 1) Pneumatic spring
- 2) Mixed, pneumatic/mechanical spring
- 3) Mechanical spring
- 4) Minimum pilot pressure 50% of operating pressure

Electrical data	
Electrical connection	Via E-box
Operating voltage	[V DC] 5, 12, 24 ±10%
Power	[W] 1, reduced to 0.35 with holding current reduction
Duty cycle ED	[%] 100
Degree of protection to EN 60529	IP40 (with plug socket), IP65 (with M8)

Information on materials	
Housing	Wrought aluminium alloy
Seals	HNBR, NBR
Note on materials	RoHS compliant

Dimensions Download CAD data → www.festo.com

2x3/2-way, 5/2-way and 5/3-way valve

- - Note
More dimensions
E-boxes
→ page 103

1 Vertical electrical connection

2 Horizontal electrical connection

3 Manual override

4 Port for external pilot air supply

Type	B1	B2	D1	D2	D3	H1	H2	H3	L1	L2	L3	L4
VUVG-L-10 -...-M7 ...	10.2	-	M7	3.2	M3	32.5	3.6	4.4	86.5	81.5	8	27
VUVG-S-10 -...-M7 ...												

Type	L5	L6	L7	L8	L9	L10	L11	L12	L13	L14
VUVG-L-10 -...-M7 ...	4.85	6.15	47	14	11	12	19	-	69.2	66.7
VUVG-S-10 -...-M7 ...										

Solenoid valves VUVG-L10 and VUVG-S10, in-line valves M7

FESTO

Ordering data

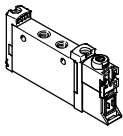
Ordering data					
		Description	Part No.	Type	
In-line valve M7, without E-box					
	2x3/2-way valve				
	Internal pilot air supply	Normally closed, reset method: pneumatic spring	566471	VUVG-L10-T32C-AT-M7-1P3	
		Normally open, reset method: pneumatic spring	566472	VUVG-L10-T32U-AT-M7-1P3	
		1x normally open, 1x normally closed, reset method: pneumatic spring	566473	VUVG-L10-T32H-AT-M7-1P3	
		Normally closed, reset method: mechanical spring	574356	VUVG-L10-T32C-MT-M7-1P3	
		Normally open, reset method: mechanical spring	574357	VUVG-L10-T32U-MT-M7-1P3	
		1x normally open, 1x normally closed, reset method: mechanical spring	574358	VUVG-L10-T32H-MT-M7-1P3	
	External pilot air supply	Normally closed, reset method: pneumatic spring	566479	VUVG-L10-T32C-AZT-M7-1P3	
		Normally open, reset method: pneumatic spring	566480	VUVG-L10-T32U-AZT-M7-1P3	
		1x normally open, 1x normally closed, reset method: pneumatic spring	566481	VUVG-L10-T32H-AZT-M7-1P3	
		Normally closed, reset method: mechanical spring	574360	VUVG-L10-T32C-MZT-M7-1P3	
		Normally open, reset method: mechanical spring	574361	VUVG-L10-T32U-MZT-M7-1P3	
		Normally closed, reset method: mechanical spring	574362	VUVG-L10-T32H-MZT-M7-1P3	
	5/2-way valve, single solenoid				
	Internal pilot air supply	Reset method: mechanical spring	574359	VUVG-L10-M52-MT-M7-1P3	
		Reset method: pneumatic/mechanical spring	566474	VUVG-L10-M52-RT-M7-1P3	
	External pilot air supply	Reset method: mechanical spring	574363	VUVG-L10-M52-MZT-M7-1P3	
		Reset method: pneumatic/mechanical spring	566482	VUVG-L10-M52-RZT-M7-1P3	
	5/2-way valve, double solenoid				
	Internal pilot air supply		566475	VUVG-L10-B52-T-M7-1P3	
	External pilot air supply		566483	VUVG-L10-B52-ZT-M7-1P3	
5/3-way valve					
Internal pilot air supply	Mid-position closed	566476	VUVG-L10-P53C-T-M7-1P3		
	Mid-position exhausted	566477	VUVG-L10-P53E-T-M7-1P3		
	Mid-position pressurised	566478	VUVG-L10-P53U-T-M7-1P3		
External pilot air supply	Mid-position closed	566484	VUVG-L10-P53C-ZT-M7-1P3		
	Mid-position exhausted	566485	VUVG-L10-P53E-ZT-M7-1P3		
	Mid-position pressurised	566486	VUVG-L10-P53U-ZT-M7-1P3		

Solenoid valves VUVG-L10 and VUVG-S10, in-line valves M7

Ordering data

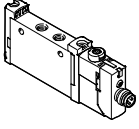
Ordering data				
	Description		Part No.	Type
In-line valve M7, with E-box R8				
	2x3/2-way valve			
	Internal pilot air supply	Normally closed, reset method: pneumatic spring	574218	VUVG-L10-T32C-AT-M7-1R8L
		Normally open, reset method: pneumatic spring	574219	VUVG-L10-T32U-AT-M7-1R8L
		1x normally open, 1x normally closed, reset method: pneumatic spring	574220	VUVG-L10-T32H-AT-M7-1R8L
	Internal pilot air supply	Normally closed, reset method: mechanical spring	8031480	VUVG-L10-T32C-MT-M7-1R8L
		Normally open, reset method: mechanical spring	8031481	VUVG-L10-T32U-MT-M7-1R8L
		1x normally open, 1x normally closed, reset method: mechanical spring	8031482	VUVG-L10-T32H-MT-M7-1R8L
	5/2-way valve, single solenoid			
	Internal pilot air supply	Reset method: pneumatic/mechanical spring	574221	VUVG-L10-M52-RT-M7-1R8L
		Reset method: mechanical spring	8031485	VUVG-L10-M52-MT-M7-1R8L
	5/2-way valve, double solenoid			
	Internal pilot air supply		574222	VUVG-L10-B52-T-M7-1R8L
5/3-way valve				
Internal pilot air supply	Mid-position closed	574223	VUVG-L10-P53C-T-M7-1R8L	
	Mid-position exhausted	574225	VUVG-L10-P53E-T-M7-1R8L	
	Mid-position pressurised	574224	VUVG-L10-P53U-T-M7-1R8L	

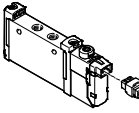
Ordering data				
	Description		Part No.	Type
In-line valve M7, with E-box H2				
	2x3/2-way valve			
	Internal pilot air supply	Normally closed, reset method: pneumatic spring	578161	VUVG-L10-T32C-AT-M7-1H2L-W1
	5/2-way valve, single solenoid			
	Internal pilot air supply	Reset method: pneumatic/mechanical spring	577333	VUVG-L10-M52-RT-M7-1H2L-W1
		Reset method: mechanical spring	578163	VUVG-L10-M52-MT-M7-1H2L-W1
	5/2-way valve, double solenoid			
	Internal pilot air supply		577332	VUVG-L10-B52-T-M7-1H2L-W1
	5/3-way valve			
Internal pilot air supply	Mid-position closed	577334	VUVG-L10-P53C-T-M7-1H2L-W1	

Solenoid valves VUVG-S10, in-line valves M5/M7

Manifold assembly



In-line valves for manifold assembly



Dimensions

Download CAD data → www.festo.com

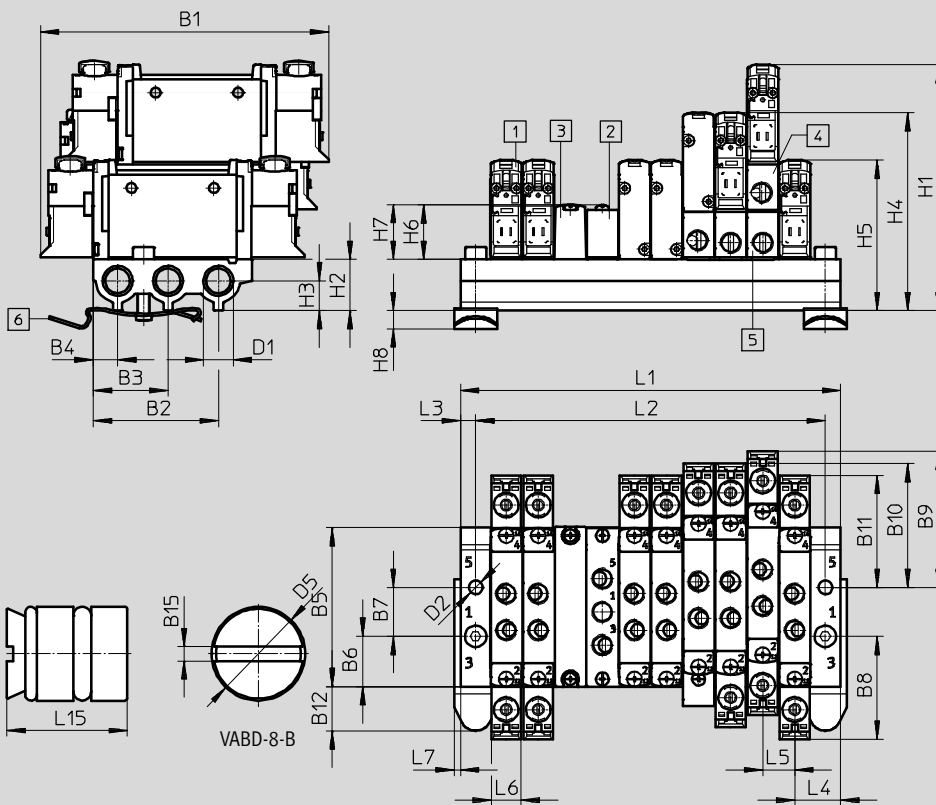

Note
More dimensions for electrical connection boxes
→ page 103

- 1 Solenoid valve, vertical electrical connection
- 2 Supply plate, ports 1, 3 and 5: M5 or M7
- 3 Blanking plate
- 4 Vertical pressure supply plate
- 5 Vertical pressure exhaust plate
- 6 H-rail mounting (two M4x20 screws to DIN 912 are required)

Type	B1	B2	B3	B4	B5	B6	B7	B8	B9	B10	B11	B12
VUVG-S10 -...-M5 ...	94.3	41	24.5	8	52.1	16.5	16	33.7	44.6	40.7	36.7	14.4

Type	D1	D2	D5	H1	H2	H3	H4	H5	H6	H7	H8	L3	L4	L5	L6	L7
VUVG-S10 -...-M5 ...	G1/8	4.5	8	80.6	16.8	9.8	64.9	49.3	17.8	18	5.9	5	15	10.5	10.3	2

Solenoid valves VUVG-S10, in-line valves M5/M7

Ordering data

Valve positions	2	3	4	5	6	7	8	9	10	12	14	16	22
L1 [mm]	40.5	51	61.5	72	82.5	93	103.5	114	124.5	145.5	166.5	187.5	250.5
L2 [mm]	30.5	41	51.5	62	72.5	83	93.5	104	114.5	135.5	156.5	177.5	240.5
VABM weight [g]	63	78	93	108	123	138	153	168	183	213	243	273	363

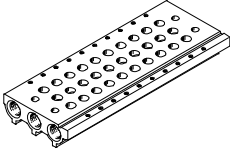
Technical data – Manifold rails							
	Connection	CRC	Material ²⁾	Operating pressure [bar]	Max. tightening torque for assembly [Nm]		
	1, 3, 5				Valve	H-rail	Wall
	G1/8	2 ¹⁾	Wrought aluminium alloy	-0.9 ... 10	0.45	1.5	3

- 1) Corrosion resistance class 2 according to Festo standard 940070
Components subject to moderate corrosion stress. Externally visible parts with primarily decorative surface requirements which are in direct contact with the surrounding industrial environment or media such as coolants or lubricating agents.
- 2) Note on materials: RoHS compliant.

Order code – Manifold rails

VABM	-	L1	-	10	S	-	G18	-	
Valve manifold parts									Number of valve positions
Manifold rail		VABM							2 to 10, 12, 14 and 16
Valve series									Port 1, 3, 5
VUVG		L1					G18		G1/8 thread
Valve size									
10 mm				10					
Manifold rail with port 1, 3, 5									
For M5 and M7 in-line valves					S				



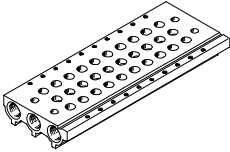



Ordering data – Manifold rail

	Description	Part No.	Type
	Manifold rail for in-line valve (manifold assembly) For size M5/M7	2 valve positions	566558 VABM-L1-10S-G18-2
		3 valve positions	566559 VABM-L1-10S-G18-3
		4 valve positions	566560 VABM-L1-10S-G18-4
		5 valve positions	566561 VABM-L1-10S-G18-5
		6 valve positions	566562 VABM-L1-10S-G18-6
		7 valve positions	566563 VABM-L1-10S-G18-7
		8 valve positions	566564 VABM-L1-10S-G18-8
		9 valve positions	566565 VABM-L1-10S-G18-9
		10 valve positions	566566 VABM-L1-10S-G18-10
		12 valve positions	566567 VABM-L1-10S-G18-12
		14 valve positions	566568 VABM-L1-10S-G18-14
		16 valve positions	566569 VABM-L1-10S-G18-16

Solenoid valves VUVG-S10, in-line valves M5/M7

FESTO

Ordering data

Ordering data – Accessories				
	Description		Part No.	Type
Blanking plate Technical data → Internet: vabb				
	For manifold rail for M5/M7 in-line valves	Incl. screws and seal	566462	VABB-L1-10-S
Separator Technical data → Internet: vabd				
	For manifold rail for M5/M7 in-line valves	Separator for pressure zones	569995	VABD-8-B
Supply plate Technical data → Internet: vabf				
	For manifold rail for M5 in-line valves	Incl. screws and seal	569991	VABF-L1-10-P3A4-M5
	For manifold rail for M7 in-line valves		569992	VABF-L1-10-P3A4-M7
Seals Technical data → Internet: vabd				
	In-line valves VUVG-L			
	For M5 in-line valves	Delivery unit: 10 sets (each with 2 screws and 1 seal)	566672	VABD-L1-10X-S-M5
	For M7 in-line valves		566673	VABD-L1-10X-S-M7
	In-line valves VUVG-LK			
	For M5 in-line valves	Delivery unit: 10 sets (each with 2 screws and 1 seal)	8043718	VABD-L1-10XK-S-M5-S
	For M7 in-line valves		8043719	VABD-L1-10XK-S-M7-S
Vertical pressure supply plate				
	Pneumatic connection 1: M7	Terminal code CP	574592	VABF-L1-P3A3-M7
Vertical exhaust plate				
	Pneumatic connection 3, 5: M7	Terminal code CR	574594	VABF-L1-P7A13-M7

Solenoid valves VUVG, in-line valves G1/8

Order code

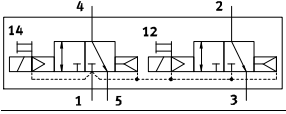
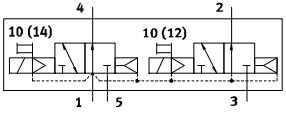
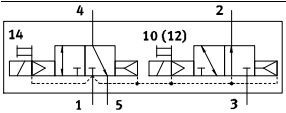
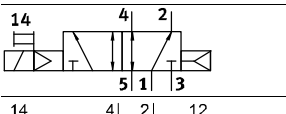
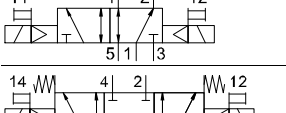
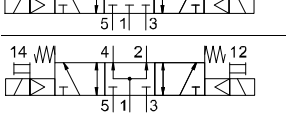
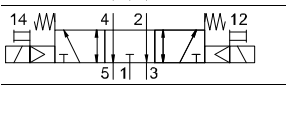
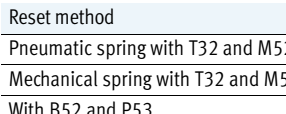
VUVG	-	14	-	-	-	-	-	-	-
Valve type									
In-line, individual valve		L							
In-line valve, manifold valve incl. seal and screw		S							
Design principle									
Piston spool with sealing cartridge		-							
Piston spool with sealing ring		K							
Valve size									
14 mm		14							
Valve functions									
									T32C
									T32U
									T32H
									M52
									B52
									P53C
									P53U
									P53E
Reset method									
Pneumatic spring with T32 and M52									A
Mechanical spring with T32 and M52									M
With B52 and P53									-
Pilot air supply port									
Internal									-
External									Z
Manual override									
Non-detenting									H
Covered									S
Non-detenting, detenting									T
Detenting, without accessories									Y

									L	-	-	-	-	-	-	-	-	-	-
										Version									
										- Extended features									
										S Focused features									
										Connecting cables									
										W1...4 Not sheathed									
										C1...4 Sheathed									
										WS1...4 Not sheathed									
										S1...4 Sheathed									
										N1...4 M8x1, 3-pin									
										N5...8 M8x1, 4-pin									
										Display									
										L LED									
										Protective circuit									
										- Without holding current reduction (HCR)									
										R With holding current reduction (HCR)									
										Electrical connection box									
										H2 Connection pattern H, horizontal plug connector									
										H3 Connection pattern H, vertical plug connector									
										S2 Connection pattern S, horizontal plug connector									
										S3 Connection pattern S, vertical plug connector									
										L1...4 with 2x flying leads L: 1 = 0.5 m, 2 = 1 m, 3 = 2.5 m, 4 = 5 m									
										K6...9 Cable: K6 = 0.5 m, K7 = 1 m, K8 = 2.5 m, K9 = 5 m									
										R1 Individual plug connector M8, 4-pin									
										R8 Individual plug connector M8, 3-pin									
										P3 Without electrical connection box									
										Operating voltage									
										1 24 V DC									
										5 12 V DC									
										4 5 V DC									
										Exhausting with VUVG-L									
										QN Push-in fitting									
										U Silencer									
										- G $\frac{1}{8}$ thread									
										Pneumatic port									
										G18 Thread G $\frac{1}{8}$									
										T14 Push-in connector $\frac{1}{4}$ "									
										T516 Push-in connector $\frac{5}{16}$ "									
										Q4 Push-in connector 4 mm/G $\frac{1}{8}$									
										Q6 Push-in connector 6 mm/G $\frac{1}{8}$									
										Q8 Push-in connector 8 mm/G $\frac{1}{8}$									

New
VUVG-LK, VUVG-BK

Solenoid valves VUVG-LK14, in-line valves G1/8

FESTO

Technical data

Function
2x3/2C
5/2-way, single solenoid
5/2-way, double solenoid

-  - Valve size 14 mm

-  - Flow rate
570 ... 660 l/min

-  - Voltage
24 V DC

Circuit symbol → page 11



General technical data VUVG-LK G1/8			
Valve function	T32-A	M52-A	B52
Normal position	C ¹⁾	–	–
Stable positions	Monostable		Bistable
Reset method: pneumatic spring	Yes	Yes	–
Design	Piston spool		
Sealing principle	Soft		
Type of actuation	Electrical		
Type of piloting	Piloted		
Pilot air supply port	Internal		
Exhaust air function	With flow control		
Manual override	Non-detenting, detenting		
Type of mounting	Optionally via through-holes ²⁾ or on manifold rail		
Mounting position	Any		
Standard nominal flow rate	[l/min] 570	660	660
Switching time on/off	[ms] 13/20	14/24	–
Changeover time	[ms] –		8
Valve size	[mm] 14		
Port	2, 4	G1/8	
Product weight	[g] 75	65	85
Corrosion resistance class CRC ³⁾	2		

1) C=Normally closed.

2) If several valves are to be screwed together via the through-holes to form a block, a minimum distance of 0.3 mm must be ensured by placing spacer discs between them.

3) Corrosion resistance class 2 to Festo standard 940 070

Components subject to moderate corrosion stress. External visible parts with primarily decorative surface requirements which are in direct contact with the surrounding industrial environment or media such as coolants or lubricating agents.

Safety data	
Note on forced checking procedure	Switching frequency min. 1/week
Max. positive test pulse with 0 signal	[μs] 1600
Max. negative test pulse with 1 signal	[μs] 3000
Resistance to shocks	Shock test with severity level 1 to FN 942017-5 and EN 60068-2-27
Vibration resistance	Transport application test with severity level 1 to FN 942017-4 and EN 60068-2-6

Solenoid valves VUVG-LK14, in-line valves G1/8

Technical data

Operating and environmental conditions			
Valve function		T32-A ¹⁾	M52-A ¹⁾
			B52
Operating medium	Compressed air in accordance with ISO 8573-2010 [7:4:4]		
Note on operating/pilot medium	Lubricated operation possible (in which case lubricated operation will always be required)		
Operating pressure	[bar]	1.5 ... 7	2.5 ... 7
Ambient temperature	[°C]	-5 ... +50	
Temperature of medium	[°C]	-5 ... +50	

1) Pneumatic spring

Electrical data	
Electrical connection	Via connecting plate
Operating voltage	[V DC] 24 ±10%
Power	[W] 0.7
Duty cycle	[%] 100
Degree of protection to EN 60529	IP40 (with plug socket), IP65/IP67 (with M8)
Signal status display	LED
Maximum switching frequency	[Hz] 2

Information on materials	
Housing	Wrought aluminium alloy
Seals	HNBR, NBR
Note on materials	RoHS compliant
	Contains PWIS (paint-wetting impairment substances)

Dimensions

2x3/2-way, 5/2-way valve, double solenoid

5/2 way valve, single solenoid

Download CAD data → www.festo.com

Note
More dimensions for electrical connection boxes
→ page 103

[2] Horizontal electrical connection [3] Manual override

Type	B1	D1	D2	H1	H3	L1	L2	L3	L4	L5
VUVG-LK14-T32C...-G18 ...	14.4	G1/8	3.3	34.8	3.2	118.9	116.4	41	37	39.7
VUVG-LK14-B52...-G18 ...						95,6	94,4			
VUVG-LK14-M52...-G18 ...										

Type	L7	L8	L9	L10	L11
VUVG-LK14-T32C...-G18 ...	66.5	18.4	14.9	17	24.8
VUVG-LK14-B52...-G18 ...					
VUVG-LK14-M52...-G18 ...					

New
VUVG-LK, VUVG-BK

FESTO

Solenoid valves VUVG-LK14, in-line valves G1/8

Ordering data

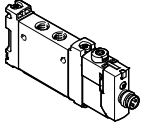
Ordering data			
	Description	Part No.	Type
In-line valve G1/8, with electrical connection box R8			
	2x3/2-way valve		
	Internal pilot air supply	Normally closed, reset method: pneumatic spring	8042566 VUVG-LK14-T32C-AT-G18-1R8L-S
	5/2-way valve, single solenoid		
	Internal pilot air supply	Reset method: pneumatic spring	8042567 VUVG-LK14-M52-AT-G18-1R8L-S
	5/2-way valve, double solenoid		
	Internal pilot air supply		8042568 VUVG-LK14-B52-T-G18-1R8L-S

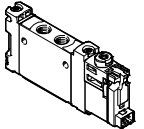
Ordering data			
	Description	Part No.	Type
In-line valve G1/8, with electrical connection box H2			
	2x3/2-way valve		
	Internal pilot air supply	Normally closed, reset method: pneumatic spring	8042562 VUVG-LK14-T32C-AT-G18-1H2L-S
	5/2-way valve, single solenoid		
	Internal pilot air supply	Reset method: pneumatic spring	8042563 VUVG-LK14-M52-AT-G18-1H2L-S
	5/2-way valve, double solenoid		
	Internal pilot air supply		8042564 VUVG-LK14-B52-T-G18-1H2L-S

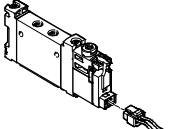
Ordering data			
	Description	Part No.	Type
In-line valve G1/8, with electrical connection box H2, connecting cable 0.5 m			
	2x3/2-way valve		
	Internal pilot air supply	Normally closed, reset method: pneumatic spring	589286 VUVG-LK14-T32C-AT-G18-1H2L-W1-S
	5/2-way valve, single solenoid		
	Internal pilot air supply	Reset method: pneumatic spring	589287 VUVG-LK14-M52-AT-G18-1H2L-W1-S
	5/2-way valve, double solenoid		
	Internal pilot air supply		589288 VUVG-LK14-B52-T-G18-1H2L-W1-S



Solenoid valves VUVG-L14 and VUVG-S14, in-line valves G1/8

Technical data

Function

2x3/2C, 2x3/2U, 2x3/2H
 5/2-way, single solenoid
 5/2-way, double solenoid
 5/3C, 5/3U, 5/3E

Circuit symbol → page 11

-  - Width 14 mm
-  - Flow rate
480 ... 730 l/min
-  - Voltage
5, 12 and 24 V DC



General technical data												
Valve function	T32-A			T32-M			M52-A	B52	M52-M	P53		
Normal position	C ¹⁾	U ²⁾	H ⁴⁾	C ¹⁾	U ²⁾	C ¹⁾	-	-	-	C ¹⁾	U ²⁾	E ³⁾
Stable position	Single solenoid							Double solenoid	Single solenoid			
Reset method: pneumatic spring	Yes			No			Yes	-	No	No		
Reset method: mechanical spring	No			Yes			No	-	Yes	Yes		
Vacuum operation at port 1	No			Only with external pilot air supply								
Design	Piston spool valve											
Sealing principle	Soft											
Actuation type	Electrical											
Type of control	Piloted											
Pilot air supply	Internal or external											
Exhaust function	With flow control											
Manual override	Choice of non-detenting, covered, non-detenting/detenting or detenting											
Type of mounting	Optionally via through-holes ⁵⁾ or on manifold rail											
Mounting position	Any											
Nominal size [mm]	4.6			4.3			5.6					
Nominal flow rate [l/min]	650	600	650	550	500	500	730	780		650	600	
Flow rate on manifold rail [l/min]	620	580		520	480	480	680	730		620	580	
Switching time on/off [ms]	8/23			11/15			14/22	-	13/35		12/40	
Changeover time [ms]	-							8	-	20		
Width [mm]	14											
Port	1, 2, 3, 4, 5 12/14			G1/8 M5								
Product weight [g]	89			80			78	89	70	89		
Approval	c UL us - Recognized (OL) c CSA us (OL)											
CE marking (see declaration of conformity)	To EU EMC Directive ⁶⁾											
Corrosion resistance class CRC ⁷⁾	2											

1) C=Normally closed/mid-position closed
 2) U=Normally open/mid-position pressurised
 3) E=Mid-position exhausted
 4) H=2x 3/2-way valve in one housing with 1x normally closed and 1x normally open
 5) If several valves are to be screwed together via the through-holes to form a block, a minimum distance of 0.3 mm must be ensured by placing spacer discs between them.
 6) For information about the applicability of the component see the manufacturer's EC declaration of conformity at: www.festo.com/sp → Certificates.
 If the component is subject to restrictions on usage in residential, office or commercial environments or small businesses, further measures to reduce the emitted interference may be necessary.
 7) Corrosion resistance class 2 according to Festo standard 940 070
 Components subject to moderate corrosion stress. Externally visible parts with primarily decorative surface requirements which are in direct contact with a normal industrial environment or media such as coolants or lubricating agents.

Solenoid valves VUVG-L14 and VUVG-S14, in-line valves G1/8

Technical data

Operating and environmental conditions			T32-A ¹⁾	T32-M ²⁾	M52-A ¹⁾	B52	M52-M ²⁾	P53
Valve function			Compressed air in accordance with ISO 8573-2010 [7:4:4]					
Operating pressure	Internal	[bar]	1.5 ... 8	3.5 ... 8	2.5 ... 8	1.5 ... 8	3 ... 8	
	External	[bar]	1.5... 10	-0.9... 10			-0.9... 8	-0.9... 10
Pilot pressure ³⁾		[bar]	1.5 ... 8	2 ... 8	2.5 ... 8	1.5 ... 8	3 ... 8	
Ambient temperature		[°C]	-5 ... +50, -5 ... +60 with holding current reduction					
Temperature of medium		[°C]	-5 ... +50, -5 ... +60 with holding current reduction					

- 1) Pneumatic spring
- 2) Mechanical spring
- 3) Minimum pilot pressure 50% of operating pressure

Electrical data	
Electrical connection	Via E-box
Operating voltage	[V DC] 5, 12 and 24 ±10%
Power	[W] 1, reduced to 0.35 with holding current reduction
Duty cycle ED	[%] 100
Degree of protection to EN 60529	IP40 (with plug socket), IP65 (with M8)

Information on materials	
Housing	Wrought aluminium alloy
Seals	HNBR, NBR
Note on materials	RoHS compliant

Dimensions Download CAD data → www.festo.com

2x3/2-way, 5/2-way and 5/3-way valve

- - Note

More dimensions
E-boxes
→ page 103

1

Horizontal electrical connection

2

Manual override

3

Connection for external pilot air supply

Type	B1	B2	D1	D2	D3	H1	H2	L1	L2	L3	L4	L5	L6
VUVG-L-14 -...-G18 ...	14.4	2.3	G1/8	∅ 3.2	M5	34.8	5.8	107	102	8	37	4.85	6.15
VUVG-S-14 -...-G18 ...													

Type	L7	L8	L9	L10	L11	L12	L13	L14	L15
VUVG-L-14 -...-G18 ...	66.5	18.35	14.9	18	24.25	13.45	10.8	89.4	86.95
VUVG-S-14 -...-G18 ...									

Solenoid valves VUVG-L14 and VUVG-S14, in-line valves G1/8

Ordering data

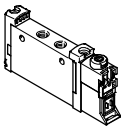
Ordering data					
	Description		Part No.	Type	
In-line valve G1/8, without E-box					
	2x3/2-way valve				
	Internal pilot air supply	Normally closed, reset method: pneumatic spring	566496	VUVG-L14-T32C-AT-G18-1P3	
		Normally open, reset method: pneumatic spring	566497	VUVG-L14-T32U-AT-G18-1P3	
		1x normally open, 1x normally closed, reset method: pneumatic spring	566498	VUVG-L14-T32H-AT-G18-1P3	
		Normally closed, reset method: mechanical spring	574368	VUVG-L14-T32C-MT-G18-1P3	
		Normally open, reset method: mechanical spring	574369	VUVG-L14-T32U-MT-G18-1P3	
		1x normally open, 1x normally closed, reset method: mechanical spring	574370	VUVG-L14-T32H-MT-G18-1P3	
	External pilot air supply	Normally closed, reset method: pneumatic spring	566505	VUVG-L14-T32C-AZT-G18-1P3	
		Normally open, reset method: pneumatic spring	566506	VUVG-L14-T32U-AZT-G18-1P3	
		1x normally open, 1x normally closed, reset method: pneumatic spring	566507	VUVG-L14-T32H-AZT-G18-1P3	
		Normally closed, reset method: mechanical spring	574372	VUVG-L14-T32C-MZT-G18-1P3	
		Normally open, reset method: mechanical spring	574373	VUVG-L14-T32U-MZT-G18-1P3	
		Normally closed, reset method: mechanical spring	574374	VUVG-L14-T32H-MZT-G18-1P3	
	5/2-way valve, single solenoid				
	Internal pilot air supply	Reset method: pneumatic spring	566499	VUVG-L14-M52-AT-G18-1P3	
		Reset method: mechanical spring	574371	VUVG-L14-M52-MT-G18-1P3	
	External pilot air supply	Reset via pneumatic spring	566508	VUVG-L14-M52-AZT-G18-1P3	
		Reset method: mechanical spring	574375	VUVG-L14-M52-MZT-G18-1P3	
	5/2-way valve, double solenoid				
	Internal pilot air supply		566500	VUVG-L14-B52-T-G18-1P3	
External pilot air supply		566509	VUVG-L14-B52-ZT-G18-1P3		
5/3-way valve					
Internal pilot air supply	Mid-position closed	566501	VUVG-L14-P53C-T-G18-1P3		
	Mid-position exhausted	566502	VUVG-L14-P53E-T-G18-1P3		
	Mid-position pressurised	566503	VUVG-L14-P53U-T-G18-1P3		
External pilot air supply	Mid-position closed	566510	VUVG-L14-P53C-ZT-G18-1P3		
	Mid-position exhausted	566511	VUVG-L14-P53E-ZT-G18-1P3		
	Mid-position pressurised	566512	VUVG-L14-P53U-ZT-G18-1P3		

Solenoid valves VUVG-L14 and VUVG-S14, in-line valves G1/8

FESTO

Ordering data

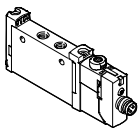
Ordering data				
Description		Part No.	Type	
In-line valve G1/8, with E-box R8				
	2x3/2-way valve			
	Internal pilot air supply	Normally closed, reset method: pneumatic spring	574226	VUVG-L14-T32C-AT-G18-1R8L
		Normally open, reset method: pneumatic spring	574227	VUVG-L14-T32U-AT-G18-1R8L
	1x normally open, 1x normally closed, reset method: pneumatic spring		574228	VUVG-L14-T32H-AT-G18-1R8L
	Normally closed, reset method: pneumatic spring		8031504	VUVG-L14-T32C-MT-G18-1R8L
	Normally open, reset method: pneumatic spring		8031505	VUVG-L14-T32U-MT-G18-1R8L
	1x normally open, 1x normally closed, reset method: pneumatic spring		8031506	VUVG-L14-T32H-MT-G18-1R8L
5/2-way valve, single solenoid				
Internal pilot air supply	Reset method: pneumatic spring	574229	VUVG-L14-M52-AT-G18-1R8L	
	Reset method: mechanical spring	8031508	VUVG-L14-M52-MT-G18-1R8L	
5/2-way valve, double solenoid				
Internal pilot air supply		574230	VUVG-L14-B52-T-G18-1R8L	
5/3-way valve				
Internal pilot air supply	Mid-position closed	574231	VUVG-L14-P53C-T-G18-1R8L	
	Mid-position exhausted	574233	VUVG-L14-P53E-T-G18-1R8L	
	Mid-position pressurised	574232	VUVG-L14-P53U-T-G18-1R8L	

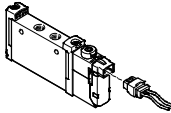
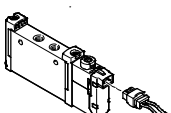
Ordering data				
Description		Part No.	Type	
In-line valve G1/8, with E-box H2				
	2x3/2-way valve			
	Internal pilot air supply	Normally closed, reset method: pneumatic spring	577321	VUVG-L14-T32C-AT-G18-1H2L-W1
		1x normally open, 1x normally closed, reset method: pneumatic spring	577323	VUVG-L14-T32H-AT-G18-1H2L-W1
	5/2-way valve, single solenoid			
	Internal pilot air supply	Reset method: pneumatic spring	576256	VUVG-L14-M52-AT-G18-1H2L-W1
		Reset method: mechanical spring	578164	VUVG-L14-M52-MT-G18-1H2L-W1
	5/2-way valve, double solenoid			
Internal pilot air supply		577319	VUVG-L14-B52-T-G18-1H2L-W1	
5/3-way valve				
Internal pilot air supply	Mid-position closed	577320	VUVG-L14-P53C-T-G18-1H2L-W1	
	Mid-position exhausted	577962	VUVG-L14-P53E-T-G18-1H2L-W1	
	Mid-position pressurised	577322	VUVG-L14-P53U-T-G18-1H2L-W1	
In-line valve for manifold assembly G1/8, with E-box H2				
	2x3/2-way valve			
	Internal pilot air supply		577342	VUVG-S14-T32C-AT-G18-1H2L-W1
	5/2-way valve, single solenoid			
	Internal pilot air supply		577325	VUVG-S14-M52-AT-G18-1H2L-W1
	5/2-way valve, double solenoid			
Internal pilot air supply		577326	VUVG-S14-B52-T-G18-1H2L-W1	

Solenoid valves VUVG-S14, in-line valves G1/8

Manifold assembly

In-line valves for manifold assembly



Dimensions

Download CAD data → www.festo.com

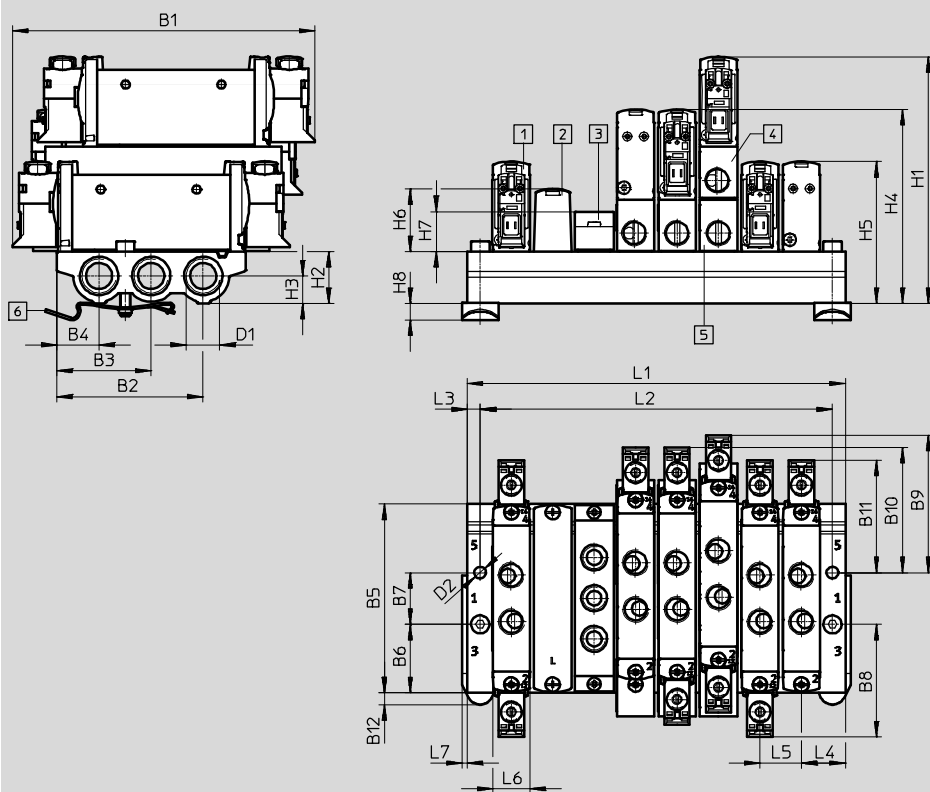

Note
More dimensions for electrical connection boxes
→ page 103

- 1 Solenoid valve, vertical electrical connection
- 2 Cover plate
- 3 Supply plate, ports 1, 3 and 5: G1/8 thread
- 4 Vertical pressure supply plate
- 5 Vertical pressure exhaust plate
- 6 H-rail mounting (two M4x25 screws to DIN 912 are required for mounting)

Type	B1	B2	B3	B4	B5	B6	B7	B8	B9	B10	B11	B12	D1	D2
VUVG-S14 -...-G18 ...	116.6	56.6	36.5	16.4	72.9	26.5	20	43.5	53.1	48.3	43.5	4.5	G $\frac{1}{4}$	4.5

Type	H1	H2	H3	H4	H5	H6	H7	H8	L3	L4	L5	L6	L7
VUVG-S14 -...-G18 ...	95.3	20	10.6	74.9	54.8	23.9	15.4	6.5	5	17	16	14.5	2

Valve positions	2	3	4	5	6	7	8	9	10	12	14	16	22
L1 [mm]	50	66	82	98	114	130	146	162	178	210	242	274	306
L2 [mm]	40	56	72	88	104	120	136	152	168	200	232	264	296
VABM weight [g]	118	159	200	241	282	323	364	405	446	528	610	692	938

Solenoid valves VUVG-S14, in-line valves G1/8

Ordering data

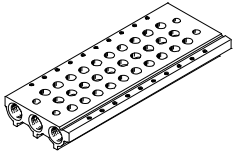
Technical data – Manifold rails							
	Connection	CRC	Material ²⁾	Operating pressure [bar]	Max. tightening torque for assembly [Nm]		
	1, 3, 5				Valve	H-rail	Wall
	G $\frac{1}{4}$	2 ¹⁾	Wrought aluminium alloy	-0.9 ... 10	0.65	1.5	3

- 1) Corrosion resistance class 2 according to Festo standard 940070
Components subject to moderate corrosion stress. Externally visible parts with primarily decorative surface requirements which are in direct contact with the surrounding industrial environment or media such as coolants or lubricating agents.
- 2) Note on materials: RoHS compliant.





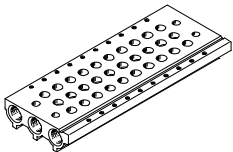

Order code – Manifold rails

VABM	-	L1	-	14	S	-	G14	-	
Valve manifold parts									Number of valve positions
Manifold rail		VABM							2 to 10, 12, 14 and 16
Valve series									Port 1, 3, 5
VUVG		L1					G14	G $\frac{1}{4}$ thread	
Valve size									
14 mm				14					
Manifold rail with port 1, 3, 5									
For G $\frac{1}{8}$ in-line valves					S				

Ordering data – Manifold rail			
	Description	Part No.	Type
	For size G1/8	2 valve positions	566618 VABM-L1-14S-G14-2
		3 valve positions	566619 VABM-L1-14S-G14-3
		4 valve positions	566620 VABM-L1-14S-G14-4
		5 valve positions	566621 VABM-L1-14S-G14-5
		6 valve positions	566622 VABM-L1-14S-G14-6
		7 valve positions	566623 VABM-L1-14S-G14-7
		8 valve positions	566624 VABM-L1-14S-G14-8
		9 valve positions	566625 VABM-L1-14S-G14-9
		10 valve positions	566626 VABM-L1-14S-G14-10
		12 valve positions	566627 VABM-L1-14S-G14-12
		14 valve positions	566628 VABM-L1-14S-G14-14
16 valve positions	566629 VABM-L1-14S-G14-16		

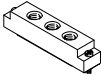
Solenoid valves VUVG-S14, in-line valves G1/8

Ordering data

Ordering data – Accessories			
	Description	Part No.	Type
Blanking plate Technical data → Internet: vabb			
	For manifold rail for G1/8 in-line valves	Incl. screws and seal	569989 VABB-L1-14
Separator Technical data → Internet: vabd			
	For manifold rail for G1/8 in-line valves	Separator for pressure zones	569996 VABD-10-B
Supply plate Technical data → Internet: vabf			
	For manifold rail for G1/8 in-line valves	Incl. screws and seal	569993 VABF-L1-14-P3A4-G18
Seals for in-line valves Technical data → Internet: vabd			
	In-line valves VUVG-L		
	For G1/8 in-line valves	Delivery unit: 10 sets (each with 2 screws and 1 seal)	566675 VABD-L1-14X-S-G18
	In-line valves VUVG-LK		
	For G1/8 in-line valves	Delivery unit: 10 sets (each with 2 screws and 1 seal)	8043720 VABD-L1-14XK-S-G18-S
Vertical pressure supply plate			
	Pneumatic connection 1: G1/8	Terminal code CP	574593 VABF-L1-P3A3-G18
Vertical exhaust plate			
	Pneumatic connection 3, 5: G1/8	Terminal code CR	574595 VABF-L1-P7A13-G18

Solenoid valves VUVG, in-line valves G1/4

Order code

FESTO

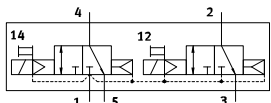
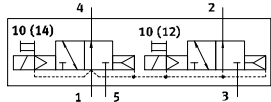
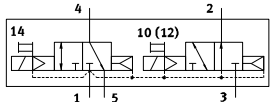
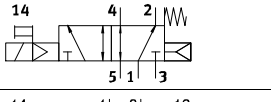
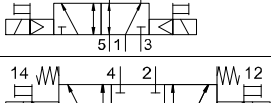
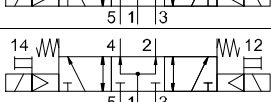
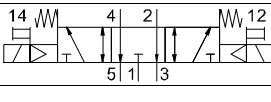
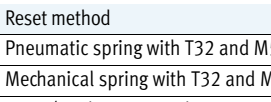
VUVG	-	18	-	-	-	-
Valve type						
In-line, individual valve	L					
In-line valve, manifold valve incl. seal and screws	S					
Design principle						
Piston spool with sealing cartridge	-					
Valve size						
18 mm		18				
Valve functions						
						T32C
						T32U
						T32H
						M52
						B52
						P53C
						P53U
						P53E
Reset method						
Pneumatic spring with T32 and M52						A
Mechanical spring with T32 and M52						M
Pneu./mech. spring with M52						R
With B52 and P53						-
Pilot air supply port						
Internal						-
External						Z
Manual override						
Non-detenting						H
Covered						S
Non-detenting, detenting						T
Detenting, without accessories						Y

						L	-
Connecting cables							
W1...4							Not Sheathed
C1...4							Sheathed
WS1...4							Not Sheathed
S1...4							Sheathed
N1...4							M8x1, 3-pin
N5...8							M8x1, 4-pin
Display							
L							LED
Protective circuit							
-							Without holding current reduction (HCR)
R							With holding current reduction (HCR)
Electrical connection box							
H2							Connection pattern H, horizontal plug connector
H3							Connection pattern H, vertical plug connector
S2							Connection pattern S, horizontal plug connector
S3							Connection pattern S, vertical plug connector
L1...4							With 2x flying leads L: 1 = 0.5 m, 2 = 1 m, 3 = 2.5 m, 4 = 5 m
K6...9							Cable: K6 = 0.5 m, K7 = 1 m, K8 = 2.5 m, K9 = 5 m
R1							Individual plug connector M8, 4-pin
R8							Individual plug connector M8, 3-pin
P3							Without electrical connection box
Operating voltage							
1							24 V DC
5							12 V DC
4							5 V DC
Exhausting with VUVG-L							
QN							Push-in fitting
U							Silencer
-							G1/4 thread
Pneumatic connection							
G14							G1/4 thread
Q6							Push-in connector 6 mm/G1/4
Q8							Push-in connector 8 mm/G1/4
Q10							Push-in connector 10 mm/G1/4
T14							Push-in connector 1/4"
T38							Push-in connector 3/8"
T516							Push-in connector 5/16"



Solenoid valves VUVG-L18 and VUVG-S18, in-line valves G1/4

Technical data

Function

2x3/2C, 2x3/2U, 2x3/2H
 5/2-way, single solenoid
 5/2-way, double solenoid
 5/3C, 5/3U, 5/3E

Circuit symbol → page 11

-  - Width 18 mm
-  - Flow rate
1000 ... 1380 l/min
-  - Voltage
5, 12 and 24 V DC



General technical data												
Valve function	T32-A			T32-M			M52-R	B52	M52-M	P53		
Normal position	C ¹⁾	U ²⁾	H ⁴⁾	C ¹⁾	U ²⁾	C ¹⁾	-	-	-	C ¹⁾	U ²⁾	E ³⁾
Stable position	Single solenoid							Double solenoid	Single solenoid			
Reset method: pneumatic spring	Yes			No			Yes ⁵⁾	-	No	No		
Reset method: mechanical spring	No			Yes			Yes ⁵⁾	-	Yes	Yes		
Vacuum operation at port 1	No			Only with external pilot air supply								
Design	Piston spool valve											
Sealing principle	Soft											
Actuation type	Electrical											
Type of control	Piloted											
Pilot air supply	Internal/external											
Exhaust function	With flow control											
Manual override	Choice of non-detenting, covered, non-detenting/detenting or detenting											
Type of mounting	Optionally via through-holes ⁶⁾ or on manifold rail											
Mounting position	Any											
Nominal size [mm]	5.7			6.9			7.3	6.9	6.5		6.3	
Nominal flow rate [l/min]	1000			1300			1380	1300	1200		1000	
Flow rate on manifold rail	1000			1300			1380	1300	1200		1000	
Switching time on/off [ms]	13/27			15/22			15/31		10/45		15/48	
Changeover time [ms]	-			-			11		-		29	
Width [mm]	18											
Port	1, 2, 3, 4, 5 12/14			G1/4 M5								
Product weight [g]	164			154			164	154	160			
Approval	c UL us - Recognized (OL) c CSA us (OL)											
CE marking (see declaration of conformity)	To EU EMC Directive ⁷⁾											
Corrosion resistance class CRC ⁸⁾	2											

1) C=Normally closed/mid-position closed
 2) U=Normally open/mid-position pressurised
 3) E=Mid-position exhausted
 4) H=2x 3/2-way valve in one housing with 1x normally closed and 1x normally open
 5) Combined reset method
 6) If several valves are to be screwed together via the through-holes to form a block, a minimum distance of 0.3 mm must be ensured by placing spacer discs between them.
 7) For information about the applicability of the component see the manufacturer's EC declaration of conformity at: www.festo.com/sp → Certificates.
 If the component is subject to restrictions on usage in residential, office or commercial environments or small businesses, further measures to reduce the emitted interference may be necessary.
 8) Corrosion resistance class 2 according to Festo standard 940 070
 Components subject to moderate corrosion stress. Externally visible parts with primarily decorative surface requirements which are in direct contact with a normal industrial environment or media such as coolants or lubricating agents.

Solenoid valves VUVG-L18 and VUVG-S18, in-line valves G1/4

Technical data

Operating and environmental conditions			T32-A ¹⁾	T32-M ³⁾	M52-R ²⁾	B52	M52-M ³⁾	P53
Valve function								
Operating medium			Compressed air in accordance with ISO 8573-2010 [7:4:4]					
Operating pressure	Internal	[bar]	1.5 ... 8	3 ... 8	2.5 ... 8	1.5 ... 8	3 ... 8	
	External	[bar]	1.5 ... 10	-0.9 ... 10				
Pilot pressure ⁴⁾		[bar]	1.5 ... 8	2 ... 8	2.5 ... 8	1.5 ... 8	3 ... 8	
Ambient temperature		[°C]	-5 ... +50, -5 ... +60 with holding current reduction					
Temperature of medium		[°C]	-5 ... +50, -5 ... +60 with holding current reduction					

- 1) Pneumatic spring
- 2) Mixed, pneumatic/mechanical spring
- 3) Mechanical spring
- 4) Minimum pilot pressure 50% of operating pressure

Electrical data	
Electrical connection	Via E-box
Operating voltage	[V DC] 5, 12 and 24 ±10%
Power	[W] 1, reduced to 0.35 with holding current reduction
Duty cycle ED	[%] 100
Degree of protection to EN 60529	IP40 (with plug socket), IP65 (with M8)

Information on materials	
Housing	Wrought aluminium alloy
Seals	HNBR, NBR
Note on materials	RoHS compliant

Dimensions Download CAD data → www.festo.com

2x3/2-way, 5/2-way and 5/3-way valve

- - Note
More dimensions
E-boxes
→ page 103

1 Electrical connection without E-box
 2 Mounting screw
 3 Connection for external pilot air supply

Type	B1	B2	D1	D2	D3	H1	H2	H3	L1	L2	L3	L4	L5
VUVG-L-18 -...	18.3	4.5	G1/4	∅ 4.2	M5	43.1	37.8	6.4	129.4	124.4	86.4	112.2	109.7
VUVG-S-18 -...													

Type	L6	L7	L8	L9	L10	L11	L12	L13
VUVG-L-18 -...	86	52	19.7	31.3	23.8	21.7	21.1	14
VUVG-S-18 -...								

Solenoid valves VUVG-L18 and VUVG-S18, in-line valves G1/4

Ordering data

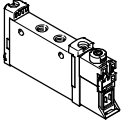
Ordering data					
	Description		Part No.	Type	
In-line valve G1/4, without E-box					
	2x3/2-way valve				
	Internal pilot air supply	Normally closed, reset method: pneumatic spring	574422	VUVG-L18-T32C-AT-G14-1P3	
		Normally open, reset method: pneumatic spring	574423	VUVG-L18-T32U-AT-G14-1P3	
		1x normally open, 1x normally closed, reset method: pneumatic spring	574424	VUVG-L18-T32H-AT-G14-1P3	
		Normally closed, reset method: mechanical spring	574425	VUVG-L18-T32C-MT-G14-1P3	
		Normally open, reset method: mechanical spring	574426	VUVG-L18-T32U-MT-G14-1P3	
		1x normally open, 1x normally closed, reset method: mechanical spring	574427	VUVG-L18-T32H-MT-G14-1P3	
	External pilot air supply	Normally closed, reset method: mechanical spring	574434	VUVG-L18-T32C-MZT-G14-1P3	
		Normally open, reset method: mechanical spring	574435	VUVG-L18-T32U-MZT-G14-1P3	
		Normally closed, reset method: mechanical spring	574436	VUVG-L18-T32H-MZT-G14-1P3	
	5/2-way valve, single solenoid				
	Internal pilot air supply	Reset method: pneumatic/mechanical spring	574428	VUVG-L18-M52-RT-G14-1P3	
		Reset via mechanical spring	574429	VUVG-L18-M52-MT-G14-1P3	
	External pilot air supply	External pilot air supply, reset method: mechanical spring	574438	VUVG-L18-M52-MZT-G14-1P3	
		External pilot air supply, pneumatic/mechanical spring return	574437	VUVG-L18-M52-RZT-G14-1P3	
	5/2-way valve, double solenoid				
	Internal pilot air supply		574430	VUVG-L18-B52-T-G14-1P3	
	External pilot air supply		574439	VUVG-L18-B52-ZT-G14-1P3	
5/3-way valve					
Internal pilot air supply	Mid-position closed	574431	VUVG-L18-P53C-T-G14-1P3		
	Mid-position exhausted	574432	VUVG-L18-P53E-T-G14-1P3		
	Mid-position pressurised	574433	VUVG-L18-P53U-T-G14-1P3		
External pilot air supply	Mid-position closed	574440	VUVG-L18-P53C-ZT-G14-1P3		
	Mid-position exhausted	574441	VUVG-L18-P53E-ZT-G14-1P3		
	Mid-position pressurised	574442	VUVG-L18-P53U-ZT-G14-1P3		

Solenoid valves VUVG-L18 and VUVG-S18, in-line valves G $\frac{1}{4}$

FESTO

Ordering data

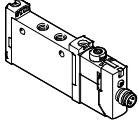
Ordering data				
Description		Part No.	Type	
In-line valve G $\frac{1}{4}$, with E-box R8				
	2x3/2-way valve			
	Internal pilot air supply	Normally closed, reset method: pneumatic spring	8031525	VUVG-L18-T32C-AT-G14-1R8L
		Normally open, reset method: pneumatic spring	8031526	VUVG-L18-T32U-AT-G14-1R8L
		1x normally open, 1x normally closed, reset method: pneumatic spring	8031527	VUVG-L18-T32H-AT-G14-1R8L
		Normally closed, reset method: mechanical spring	8031528	VUVG-L18-T32C-MT-G14-1R8L
		Normally open, reset method: mechanical spring	8031529	VUVG-L18-T32U-MT-G14-1R8L
		1x normally open, 1x normally closed, reset method: mechanical spring	8031530	VUVG-L18-T32H-MT-G14-1R8L
	5/2-way valve, single solenoid			
	Internal pilot air supply	Reset method: pneumatic/mechanical spring	8031531	VUVG-L18-M52-RT-G14-1R8L
		Reset method: mechanical spring	8031532	VUVG-L18-M52-MT-G14-1R8L
5/2-way valve, double solenoid				
Internal pilot air supply		8031533	VUVG-L18-B52-T-G14-1R8L	
5/3-way valve				
Internal pilot air supply	Mid-position closed	8031534	VUVG-L18-P53C-T-G14-1R8L	
	Mid-position exhausted	8031535	VUVG-L18-P53E-T-G14-1R8L	
	Mid-position pressurised	8031536	VUVG-L18-P53U-T-G14-1R8L	

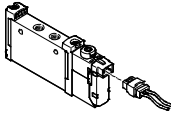
Ordering data				
Description		Part No.	Type	
In-line valve G $\frac{1}{4}$, with E-box H2				
	2x3/2-way valve			
	Internal pilot air supply	Normally closed, reset method: pneumatic spring	578822	VUVG-L18-T32C-AT-G14-1H2L-W1
		Normally open, reset method: pneumatic spring	578823	VUVG-L18-T32U-AT-G14-1H2L-W1
	5/2-way valve, single solenoid			
	Internal pilot air supply	Reset method: pneumatic spring	578823	VUVG-L18-M52-RT-G14-1H2L-W1
		Mechanical spring reset method	578824	VUVG-L18-M52-MT-G14-1H2L-W1
	5/2-way valve, double solenoid			
	Internal pilot air supply		578825	VUVG-L18-B52-T-G14-1H2L-W1
5/3-way valve				
Internal pilot air supply		578826	VUVG-L18-P53C-T-G14-1H2L-W1	

Solenoid valves VUVG-S18, in-line valves G1/4

Manifold assembly

In-line valves for manifold assembly



Dimensions

Download CAD data → www.festo.com

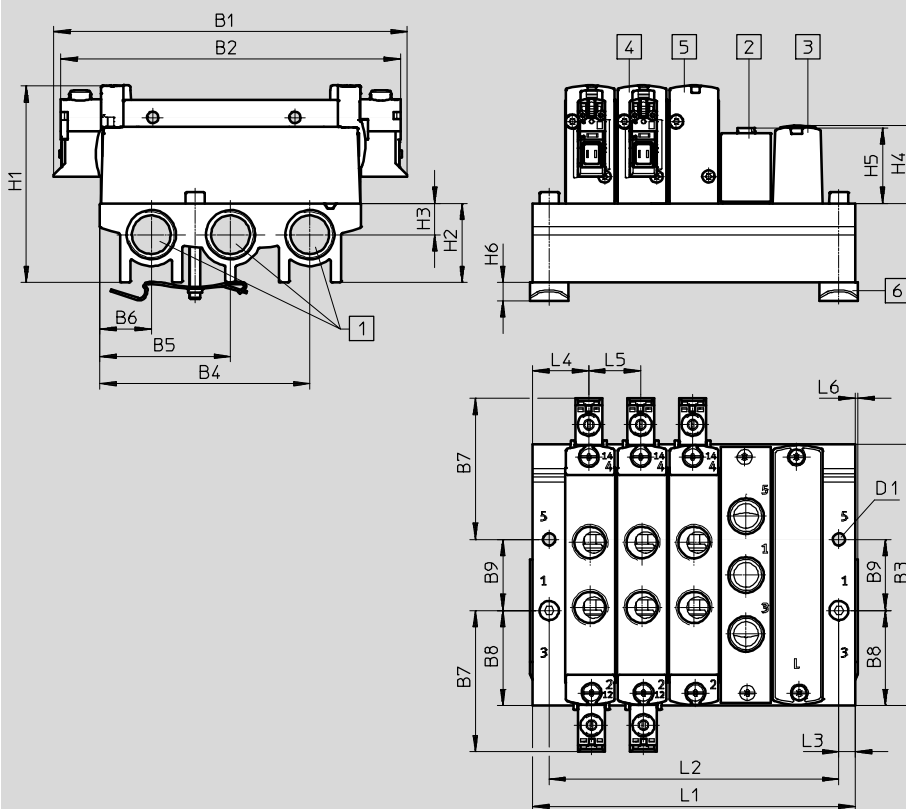

Note
More dimensions
E-boxes
→ page 103

- 1 Ports 1, 3 and 5: G3/8 thread (at both ends)
- 2 Cover plate
- 3 Supply plate, ports 1, 3 and 5: G1/4 thread
- 4 Double solenoid valve
- 5 Single solenoid valve
- 6 H-rail mounting (two M4x35 screws to DIN 912 are required for mounting)

Type	B1	B2	B3	B4	B5	B6	B7	B8	B9	D1
VUVG-S18 -...-G14 ...	129.4	124.4	95.6	76.8	47.8	18.8	51.7	34.8	26	4.5

Type	H1	H2	H3	H4	H5	H6	L3	L4	L5	L6
VUVG-S18 -...-G14 ...	72.1	29	11.5	28.4	27.6	6.5	6	20.5	19	1

Valve positions	2	3	4	5	6	7	8	9	10	12	14	16
L1 [mm]	61	80	99	118	137	156	175	194	213	251	289	327
L2 [mm]	49	68	87	106	125	144	163	182	201	239	277	315
VABM weight [g]	118	159	200	241	282	323	364	405	446	528	610	692

Solenoid valves VUVG-S18, in-line valves G $\frac{1}{4}$

Ordering data

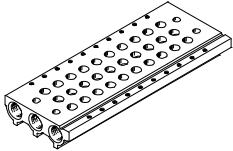
Technical data – Manifold rails							
	Port	CRC	Material ²⁾	Operating pressure [bar]	Max. tightening torque for assembly [Nm]		
	1, 3, 5				Valve	H-rail	Wall
	G $\frac{3}{8}$	2 ¹⁾	Wrought aluminium alloy	-0.9 ... 10	1.18	1.5	3

- 1) Corrosion resistance class 2 according to Festo standard 940070
Components subject to moderate corrosion stress. Externally visible parts with primarily decorative surface requirements which are in direct contact with a normal industrial environment or media such as coolants or lubricating agents.
- 2) Note on materials: RoHS-compliant.

Order code – Manifold rails



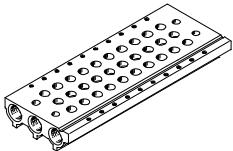

VABM	-	L1	-	18	S	-	G38	-	
Valve manifold parts									Number of valve positions
Manifold rail		VABM							2 to 10, 12, 14 and 16
Valve series									Port 1, 3, 5
VUVG		L1							G38 G $\frac{3}{8}$ thread
Valve width									
18 mm				18					
Manifold rail with port 1, 3, 5									
For G $\frac{1}{4}$ in-line valves					S				

Ordering data – Manifold rail

	Description	Part No.	Type
	For valve size G $\frac{1}{4}$	2 valve positions	574455 VABM-L1-18S-G38-2
		3 valve positions	574456 VABM-L1-18S-G38-3
		4 valve positions	574457 VABM-L1-18S-G38-4
		5 valve positions	574458 VABM-L1-18S-G38-5
		6 valve positions	574459 VABM-L1-18S-G38-6
		7 valve positions	574460 VABM-L1-18S-G38-7
		8 valve positions	574461 VABM-L1-18S-G38-8
		9 valve positions	574462 VABM-L1-18S-G38-9
		10 valve positions	574463 VABM-L1-18S-G38-10
		12 valve positions	574464 VABM-L1-18S-G38-12
		14 valve positions	574465 VABM-L1-18S-G38-14
16 valve positions	574466 VABM-L1-18S-G38-16		

Solenoid valves VUVG-S18, in-line valves G1/4

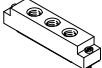
Ordering data

Ordering data – Accessories			
	Description	Part No.	Type
Blanking plate Technical data → Internet: vabb			
	For manifold rail for G1/4 in-line valves	Incl. screws and seal	574482 VABB-L1-18
Separator Technical data → Internet: vabd			
	For manifold rail for G1/4 in-line valves	Separator for pressure zones	574483 VABD-14-B
Supply plate Technical data → Internet: vabf			
	For manifold rail for G1/4 in-line valves	Incl. screws and seal	574481 VABF-L1-18-P3A4-G14
Seals for in-line valves Technical data → Internet: vabd			
	For G1/4 in-line valves	Delivery unit: 10 sets (each with 2 screws and 1 seal)	574479 VABD-L1-18X-S-G14

-  - Note
 Connect supply plate at port 1 with compressed air. Reverse operation (pressure at port 3, 5) is not permissible.

Solenoid valves VUVG, sub-base valves M3

Order code

VUVG	-	B	10A	-	-	Z
Valve type						
Sub-base, manifold valve incl. seal and screws						B
Design principle						
Piston spool with sealing cartridge						-
Valve size						
10 mm						10A
Valve functions						
						M52
						B52
						P53C
						P53U
						P53E
Reset method						
Mech. spring with M52						M
Pneu./mech. spring with M52						R
With B52 and P53						-
Pilot air supply port						
External						Z
Manual override						
Non-detenting						H
Covered						S
Non-detenting, detenting						T
Detenting, without accessories						Y

F	-	L	-
Connecting cables			
W1...4	Not sheathed		
C1...4	Sheathed		
WS1...4	Not sheathed		
S1...4	Sheathed		
N1...4	M8x1, 3-pin		
N5...8	M8x1, 4-pin		
Display			
L	LED		
Protective circuit			
-	Without holding current reduction (HCR)		
R	With holding current reduction (HCR)		
Electrical connection box			
H2	Connection pattern H, horizontal plug connector		
H3	Connection pattern H, vertical plug connector		
S2	Connection pattern S, horizontal plug connector		
S3	Connection pattern S, vertical plug connector		
L1...4	With 2x flying leads L: 1 = 0.5 m, 2 = 1 m, 3 = 2.5 m, 4 = 5 m		
K6...9	Cable: K6 = 0.5 m, K7 = 1 m, K8 = 2.5 m, K9 = 5 m		
R1	Individual plug connector M8, 4-pin		
R8	Individual plug connector M8, 3-pin		
P3	Without electrical connection box		
Operating voltage			
1	24 V DC		
5	12 V DC		
4	5 V DC		
Pneumatic port			
F	In the manifold rail		



Solenoid valves VUVG-B10A, sub-base valves

Technical data

Function

- 5/2-way, single solenoid
- 5/2-way, double solenoid
- 5/3C, 5/3U, 5/3E

Circuit symbol → page 11

-  - Width 10 mm
-  - Flow rate
90 ... 100 l/min
-  - Voltage
5, 12 and 24 V DC



General technical data						
Valve function	M52-R	B52	M52-M	P53		
Normal position	-	-	-	C ¹⁾	U ²⁾	E ³⁾
Stable position	Single solenoid	Double solenoid	Single solenoid	Single solenoid		
Reset method: pneumatic spring	Yes ⁴⁾	-	No	No		
Reset method: mechanical spring	Yes ⁴⁾	-	Yes	Yes		
Vacuum operation at port 1	Only with external pilot air supply					
Design	Piston spool valve					
Sealing principle	Soft					
Actuation type	Electrical					
Type of control	Piloted					
Pilot air supply	External, internal; can be selected via sub-base					
Exhaust function	With flow control					
Manual override	Choice of non-detenting, covered, non-detenting/detenting or detenting					
Type of mounting	On manifold rail					
Mounting position	Any					
Nominal size	[mm]	2	1.4	2		
Nominal flow rate	[l/min]	100	80	90		
Flow rate on manifold rail M3	[l/min]	100	80	90		
Switching time on/off	[ms]	7/15	-	7/21	8/25	
Changeover time	[ms]	-	5	-	14	
Width	[mm]	10				
Port	1, 3, 5	M7 in manifold rail				
	2, 4	M5 in manifold rail				
	12/14, 82/84	M5 in manifold rail				
Product weight	[g]	38	49	37	49	
Approval	c UL us - Recognized (OL)					
	c CSA us (OL)					
CE marking (see declaration of conformity)	To EU EMC Directive ⁵⁾					
Corrosion resistance class CRC ⁶⁾	2					

1) C=Normally closed/mid-position closed
 2) U=Normally open/mid-position pressurised
 3) E=Mid-position exhausted
 4) Combined reset method
 5) For information about the applicability of the component see the manufacturer's EC declaration of conformity at: www.festo.com/sp → Certificates.
 If the component is subject to restrictions on usage in residential, office or commercial environments or small businesses, further measures to reduce the emitted interference may be necessary.
 6) Corrosion resistance class 2 according to Festo standard 940 070
 Components subject to moderate corrosion stress. Externally visible parts with primarily decorative surface requirements which are in direct contact with a normal industrial environment or media such as coolants or lubricating agents.

Solenoid valves VUVG-B10A, sub-base valves

Technical data

Operating and environmental conditions					
Valve function		M52-R ¹⁾	B52	M52-M ²⁾	P53
Operating medium		Compressed air in accordance with ISO 8573-2010 [7:4:4]			
Operating pressure	Internal [bar]	2.5 ... 8	1.5 ... 8	3 ... 8	
	External [bar]	-0.9 ... 10		-0.9 ... 8	-0.9 ... 10
Pilot pressure ³⁾ [bar]		2.5 ... 8	1.5 ... 8	2 ... 8	3 ... 8
Ambient temperature [°C]		-5 ... +50, -5 ... +60 with holding current reduction			
Temperature of medium [°C]		-5 ... +50, -5 ... +60 with holding current reduction			

- 1) Mixed, pneumatic/mechanical spring
- 2) Mechanical spring
- 3) Minimum pilot pressure 50% of operating pressure

Electrical data	
Electrical connection	Via E-box
Operating voltage [V DC]	5, 12 and 24 ±10%
Power [W]	1, reduced to 0.35 with holding current reduction
Duty cycle ED [%]	100
Degree of protection to EN 60529	IP40 (with plug socket), IP65 (with M8)

Information on materials	
Housing	Wrought aluminium alloy
Seals	HNBR, NBR
Note on materials	RoHS compliant

Dimensions Download CAD data → www.festo.com

5/2-way and 5/3-way valve

1 Vertical electrical connection 2 Manual override

- - Note
 More dimensions
 E-boxes
 → page 103

Type	B1	H1	L1	L2	L3	L4	L5	L6	L7
VUVG-B10A -...-F ...	10.2	32.5	73.9	68.9	8	4.85	6.15	56.9	54.4

Solenoid valves VUVG-B10A, sub-base valves

Ordering data

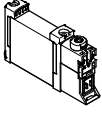
Ordering data				
	Description	Part No.	Type	
Sub-base valve M3, without E-box				
	5/2-way valve, single solenoid			
	External pilot air supply	Reset method: pneumatic/mechanical spring	566448	VUVG-B10A-M52-RZT-F-1P3
		Reset method: mechanical spring	574347	VUVG-B10A-M52-MZT-F-1P3
	5/2-way valve, double solenoid			
	External pilot air supply		566449	VUVG-B10A-B52-ZT-F-1P3
	5/3-way valve			
	External pilot air supply	Mid-position closed	566450	VUVG-B10A-P53C-ZT-F-1P3
		Mid-position exhausted	566451	VUVG-B10A-P53E-ZT-F-1P3
		Mid-position pressurised	566452	VUVG-B10A-P53U-ZT-F-1P3

Solenoid valves VUVG-B10A, sub-base valves

Manifold assembly



Sub-base valve for manifold assembly
M5 connection

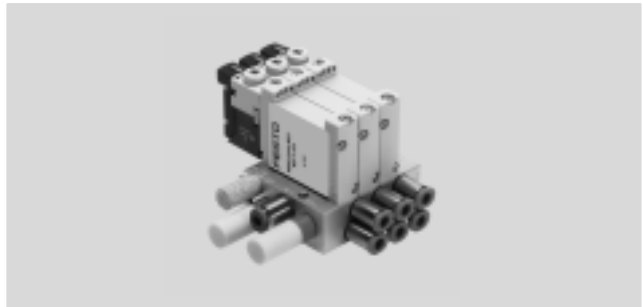

Dimensions

Download CAD data → www.festo.com

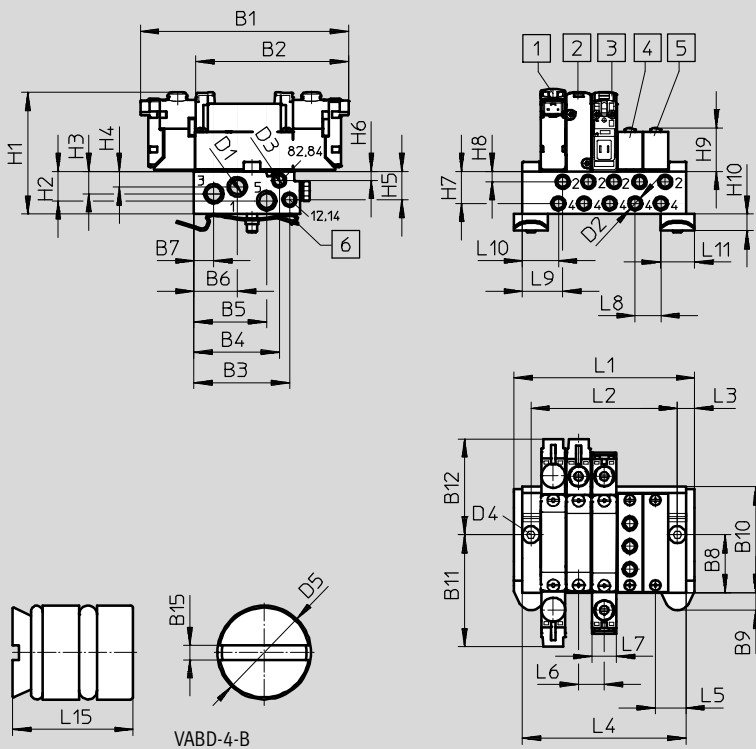

Note
More dimensions
E-boxes
→ page 103

- 1 Solenoid valve
- 2 Solenoid valve
- 3 Solenoid valve
- 4 Supply plate
- 5 Blanking plate
- 6 H-rail mounting
(two screws M4x25 to DIN 912 are required)

Type	B1	B2	B3	B4	B5	B6	B7	B8	B9	B10	B11	B12
VUVG-B10A -...-F- ...	84.9	62.4	39.12	34.95	29.83	17.75	8.15	24	7.15	43.5	45.75	39.15

Type	B15	D1	D2	D3	D4	D5	H1	H2	H3	H4	H5	H6
VUVG-B10A -...-F- ...	0.48	M7	M5	M5	∅ 4.5	∅ 4	53.1	12	9.1	6.3	11.57	3.6

Type	H7	H8	H9	H10	H15	L3	L5	L6	L7	L8	L9	L10	L11	L15
VUVG-B10A -...-F- ...	13.1	4.2	16.2	6.8	1.9	7.5	12.5	10.5	10.2	10.5	16.5	14.7	14	8.5

Solenoid valves VUVG-B10A, sub-base valves

Ordering data

Valve positions	2	3	4	5	6	7	8	9	10	12	14	16
L1 [mm]	43.5	54	64.5	75	85.5	97	107.5	117	127.5	148.5	169.5	190.5
L2 [mm]	28.5	39	49.5	60	70.5	81	91.5	102	112.5	133.5	154.5	175.5
L4 [mm]	36.5	47	57.5	68	78.5	89	99.5	110	120.5	141.5	162.5	183.5
VABM weight [g]	60	78	96	114	132	150	168	186	204	240	276	312

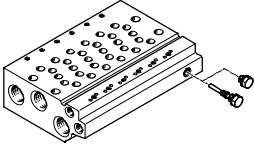
Technical data – Manifold rails ¹⁾									
	Port			CRC	Material ³⁾	Operating pressure [bar]	Max. tightening torque for assembly [Nm]		
	2, 4	1, 3, 5	12/14, 82/84				Valve	H-rail	Wall
	M5	M7	M5	2 ²⁾	Wrought aluminium alloy	-0.9 ... 10	0.45	1.5	1.5

- 1) Blanking plugs are included with the manifold rail.
- 2) Corrosion resistance class 2 according to Festo standard 940 070
Components subject to moderate corrosion stress. Externally visible parts with primarily decorative surface requirements which are in direct contact with a normal industrial environment or media such as coolants or lubricating agents.
- 3) Note on materials: RoHS-compliant.

Order code – Manifold rails



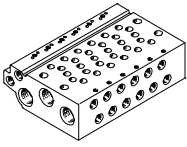

VABM	-	L1	-	10A	W	-	M7	-	
Valve manifold parts									Number of valve positions
Manifold rail		VABM							2 to 10, 12, 14 and 16
Valve series							Port 1, 3, 5		
VUVG		L1					M7	M7 thread	
Valve width									
10 mm				10A					
Manifold rail with port 1, 2, 3, 4, 5, 12/14, 82/84									
Port 2 and 4 with thread M5 thread					W				

Ordering data – Manifold rails

Description	Part No.	Type	
Manifold rail for sub-base valve M3			
	For valve size B10A (M3)		
	2 valve positions	566546	VABM-L1-10AW-M7-2
	3 valve positions	566547	VABM-L1-10AW-M7-3
	4 valve positions	566548	VABM-L1-10AW-M7-4
	5 valve positions	566549	VABM-L1-10AW-M7-5
	6 valve positions	566550	VABM-L1-10AW-M7-6
	7 valve positions	566551	VABM-L1-10AW-M7-7
	8 valve positions	566552	VABM-L1-10AW-M7-8
	9 valve positions	566553	VABM-L1-10AW-M7-9
	10 valve positions	566554	VABM-L1-10AW-M7-10
	12 valve positions	566555	VABM-L1-10AW-M7-12
14 valve positions	566556	VABM-L1-10AW-M7-14	
16 valve positions	566557	VABM-L1-10AW-M7-16	



Solenoid valves VUVG-B10A, sub-base valves

Ordering data

Ordering data – Accessories			
	Description	Part No.	Type
Blanking plate Technical data → Internet: vabb			
	For manifold rail 10AW	Incl. screws and seal	569986 VABB-L1-10A
Separator Technical data → Internet: vabd			
	For manifold rail 10AW	Separator for pressure zones	570872 VABD-4.2-B
Supply plate Technical data → Internet: vabf			
	For manifold rail 10AW	Incl. screws and seal	569990 VABF-L1-10A-P3A4-M5
Seals Technical data → Internet: vabd			
	For sub-base valve M3	Delivery unit: 10 sets (each with 2 screws and 1 seal)	566671 VABD-L1-10AB-S-M3

Solenoid valves VUVG, sub-base valves M5/M7

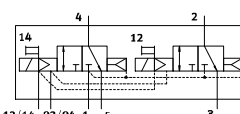
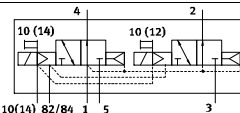
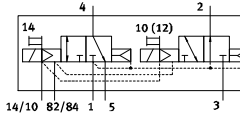
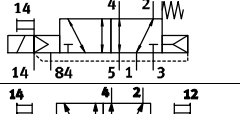
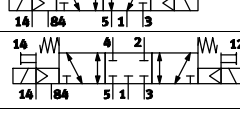
Order code

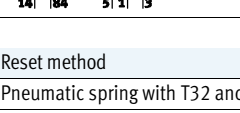
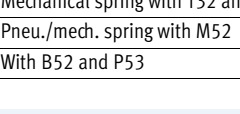
VUVG	-	B	10	-	-	-	-	Z	
Valve type									
Sub-base, manifold valve incl. seal and screws								B	
Design principle									
Piston spool with sealing cartridge								-	
Piston spool with sealing ring								K	
Valve size									
10 mm								10	
Valve functions									
								T32C	
								T32U	
								T32H	
								M52	
								B52	
								P53C	
								P53U	
								P53E	
Reset method									
Pneumatic spring with T32 and M52								A	
Mechanical spring with T32 and M52								M	
Pneu./mech. spring with M52								R	
With B52 and P53								-	
Pilot air supply port									
External								Z	
Manual override									
Non-detenting								H	
Covered								S	
Non-detenting, detenting								T	
Detenting, without accessories								Y	

F	-	-	-	-	-	-	-	-	-	L	-	-	-	-	-	-	-	-	-	-
Version																				
-																		Extended features		
S																		Focused features		
Connecting cables																				
W1...4																		Not sheathed		
C1...4																		Sheathed		
WS1...4																		Not sheathed		
S1...4																		Sheathed		
N1...4																		M8x1, 3-pin		
N5...8																		M8x1, 4-pin		
Display																				
L																		LED		
Protective circuit																				
-																		Without holding current reduction (HCR)		
R																		With holding current reduction (HCR)		
Electrical connection box																				
H2																		Connection pattern H, horizontal plug connector		
H3																		Connection pattern H, vertical plug connector		
S2																		Connection pattern S, horizontal plug connector		
S3																		Connection pattern S, vertical plug connector		
L1...4																		with 2x flying leads L: 1 = 0.5 m, 2 = 1 m, 3 = 2.5 m, 4 = 5 m		
K6...9																		Cable: K6 = 0.5 m, K7 = 1 m, K8 = 2.5 m, K9 = 5 m		
R1																		Individual plug connector M8, 4-pin		
R8																		Individual plug connector M8, 3-pin		
P3																		Without electrical connection box		
Operating voltage																				
1																		24 V DC		
5																		12 V DC		
4																		5 V DC		
Pneumatic port																				
F																		In the manifold rail		

New
VUVG-LK, VUVG-BK

Solenoid valves VUVG-BK10, sub-base valves M5/M7

FESTO

Technical data

Function
2x3/2C
5/2-way, single solenoid
5/2-way, double solenoid

-  - Valve size 10 mm

-  - Flow rate
160 l/min

-  - Voltage
24 V DC

Circuit symbol → page 11

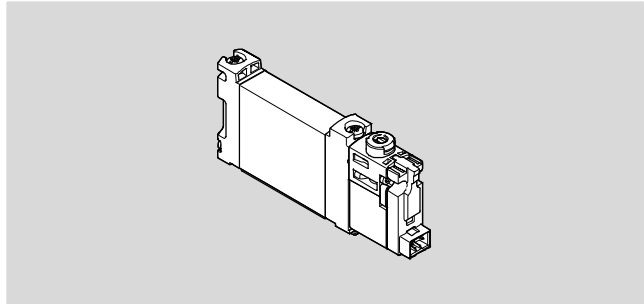

General technical data VUVG-BK M5/M7			
Valve function	T32-A	M52-A	B52
Normal position	C ¹⁾	-	-
Stable positions	Monostable		Bistable
Reset method: pneumatic spring	Yes	Yes	-
Design	Piston spool		
Sealing principle	Soft		
Type of actuation	Electrical		
Type of piloting	Piloted		
Pilot air supply	Internal		
Exhaust air function	With flow control		
Manual override	Non-detenting, detenting		
Type of mounting	On manifold rail		
Mounting position	Any		
Standard nominal flow rate	[l/min] 160	160	160
Switching time on/off	[ms] 12/14	14/17	-
Changeover time	[ms] -	-	7
Valve size	[mm] 10		
Port	2, 4	M5/M7 in manifold rail	
Product weight	[g] 55	45	57
Corrosion resistance class CRC ²⁾	2		

1) C=Normally closed.

2) Corrosion resistance class 2 to Festo standard 940 070

Components subject to moderate corrosion stress. External visible parts with primarily decorative surface requirements which are in direct contact with the surrounding industrial environment or media such as coolants or lubricating agents.

Safety data	
Note on forced checking procedure	Switching frequency min. 1/week
Max. positive test pulse with 0 signal	[µs] 1600
Max. negative test pulse with 1 signal	[µs] 3000
Resistance to shocks	Shock test with severity level 1 to FN 942017-5 and EN 60068-2-27
Vibration resistance	Transport application test with severity level 1 to FN 942017-4 and EN 60068-2-6

Solenoid valves VUVG-BK10, sub-base valves M5/M7

Technical data

Operating and environmental conditions			
Valve function		T32-A ¹⁾	M52-A ¹⁾
Operating medium		Compressed air in accordance with ISO 8573-2010 [7:4:4]	
Note on operating/pilot medium		Lubricated operation possible (in which case lubricated operation will always be required)	
Operating pressure	[bar]	1.5 ... 7	2.5 ... 7
Ambient temperature	[°C]	-5 ... +50	
Temperature of medium	[°C]	-5 ... +50	

1) Pneumatic spring

Electrical data	
Electrical connection	Via connecting plate
Operating voltage	[V DC] 24 ±10%
Nominal operating voltage	[V DC] 22
Power	[W] 0.7
Duty cycle	[%] 100
Degree of protection to EN 60529	IP40 (with plug socket), IP65/IP67 (with M8)
Signal status display	LED
Maximum switching frequency	[Hz] 2

Information on materials	
Housing	Wrought aluminium alloy
Seals	HNBR, NBR
Note on materials	RoHS compliant Contains PWIS (paint-wetting impairment substances)

Dimensions Download CAD data → www.festo.com

2x3/2-way, 5/2-way valve, double solenoid 5/2 way valve, single solenoid

2 Horizontal electrical connection **3** Manual override

Note
More dimensions for electrical connection boxes
→ page 103

Type	B1	H1	L1	L2	L7
VUVG-BK10-T32C-...	10.2	33.6	98.3	95.8	47
VUVG-BK10-B52-...					
VUVG-BK10-M52-...			75.9	74.6	

 **New**
VUVG-LK, VUVG-BK

Solenoid valves VUVG-BK10, sub-base valves M5/M7

FESTO

Ordering data

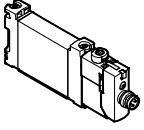
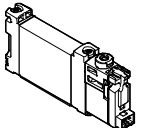
Ordering data			
	Description	Part No.	Type
Sub-base valve M5/M7, with electrical connection box R8			
	2x3/2-way valve		
	External pilot air supply	Normally closed, reset method: pneumatic spring	8042558 VUVG-BK10-T32C-AT-F-1R8L-S
	5/2-way valve, single solenoid		
	External pilot air supply	Reset method: pneumatic spring	8042559 VUVG-BK10-M52-AT-F-1R8L-S
	5/2-way valve, double solenoid		
	External pilot air supply		8042560 VUVG-BK10-B52-T-F-1R8L-S
Sub-base valve M5/M7, with electrical connection box H2			
	2x3/2-way valve		
	External pilot air supply	Normally closed, reset method: pneumatic spring	8042554 VUVG-BK10-T32C-AT-F-1H2L-S
	5/2-way valve, single solenoid		
	External pilot air supply	Reset method: pneumatic spring	8042555 VUVG-BK10-M52-AT-F-1H2L-S
	5/2-way valve, double solenoid		
	External pilot air supply		8042556 VUVG-BK10-B52-T-F-1H2L-S



Solenoid valves VUVG-B10, sub-base valves

Technical data

Function

2x3/2C, 2x3/2U, 2x3/2H
 5/2-way, single solenoid
 5/2-way, double solenoid
 5/3C, 5/3U, 5/3E

Circuit symbol → page 11

-  - Width 10 mm
-  - Flow rate
120 ... 270 l/min
-  - Voltage
5, 12 and 24 V DC

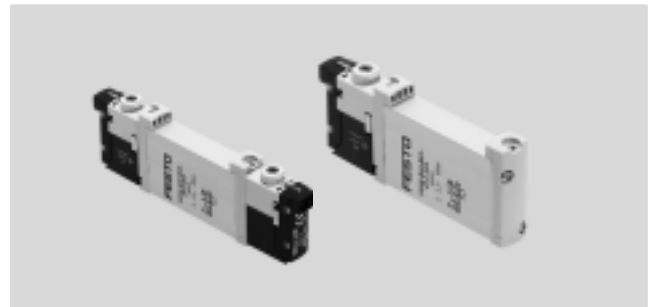

General technical data										
Valve function	T32-A			T32-M			M52-R	B52	M52-M	P53
Normal position	C ¹⁾	U ²⁾	H ⁴⁾	C ¹⁾	U ²⁾	H ⁴⁾	-	-	-	C ¹⁾ U ²⁾ E ³⁾
Stable position	Single solenoid							Double solenoid	Single solenoid	Single solenoid
Reset method: pneumatic spring	Yes			No			Yes ⁵⁾	-	No	No
Reset method: mechanical spring	No			Yes			Yes ⁵⁾	-	Yes	Yes
Vacuum operation at port 1	No			Only with external pilot air supply						
Design	Piston spool valve									
Sealing principle	Soft									
Actuation type	Electrical									
Type of pilot control	Piloted									
Pilot air supply	External, internal; can be selected via sub-base									
Exhaust function	With flow control									
Manual override	Choice of non-detenting, covered, non-detenting/detenting or detenting									
Type of mounting	On manifold rail									
Mounting position	Any									
Nominal size [mm]	2.7			1.8	1.7		4		2.3	3.5
Nominal flow rate [l/min]	170			150	140	140	330		285	300
Flow rate on manifold rail M5 [l/min]	150			130	120	120	210		180	200
Flow rate on manifold rail M7 [l/min]	160			140	130	130	270		230	250
Switching time on/off [ms]	6/16			8/11			7/19	-	8/24	10/30
Changeover time [ms]	-							7	16	
Width [mm]	10									
Port	1, 3, 5			G ^{1/8} in manifold rail						
	2, 4			M5 or M7 in manifold rail						
	12/14, 82/84			M5 in manifold rail						
Product weight [g]	55			54			45	55	44	55
Approval	c UL us - Recognized (OL) c CSA us (OL)									
CE marking (see declaration of conformity)	To EU EMC Directive ⁶⁾									
Corrosion resistance class CRC ⁷⁾	2									

1) C=Normally closed/mid-position closed
 2) U=Normally open/mid-position pressurised
 3) E=Mid-position exhausted
 4) H=2x 3/2-way valve in one housing with 1x normally closed and 1x normally open
 5) Combined reset method
 6) For information about the applicability of the component see the manufacturer's EC declaration of conformity at: www.festo.com/sp → Certificates.
 If the component is subject to restrictions on usage in residential, office or commercial environments or small businesses, further measures to reduce the emitted interference may be necessary.
 7) Corrosion resistance class 2 according to Festo standard 940 070
 Components subject to moderate corrosion stress. Externally visible parts with primarily decorative surface requirements which are in direct contact with a normal industrial environment or media such as coolants or lubricating agents.

Solenoid valves VUVG-B10, sub-base valves

Technical data

Operating and environmental conditions								
Valve function			T32-A ¹⁾	T32-M ³⁾	M52-R ²⁾	B52	M52-M ³⁾	P53
Operating medium		Compressed air in accordance with ISO 8573-2010 [7:4:4]						
Operating pressure	Internal	[bar]	1.5 ... 8	3 ... 8	2.5 ... 8	1.5 ... 8	3 ... 8	
	External	[bar]	1.5 ... 10	-0.9 ... 10			-0.9 ... 8	-0.9 ... 10
Pilot pressure ⁴⁾		[bar]	1.5 ... 8	2 ... 8	2.5 ... 8	1.5 ... 8	3 ... 8	
Ambient temperature		[°C]	-5 ... +50, -5 ... +60 with holding current reduction					
Temperature of medium		[°C]	-5 ... +50, -5 ... +60 with holding current reduction					

- 1) Pneumatic spring
- 2) Mixed, pneumatic/mechanical spring
- 3) Mechanical spring
- 4) Minimum pilot pressure 50% of operating pressure

Electrical data	
Electrical connection	Via connecting plate
Operating voltage	[V DC] 5, 12 and 24 ±10%
Power	[W] 1, reduced to 0.35 with holding current reduction
Duty cycle ED	[%] 100
Degree of protection to EN 60529	IP40 (with plug socket), IP65 (with M8)

Information on materials	
Housing	Wrought aluminium alloy
Seals	HNBR, NBR
Note on materials	RoHS compliant

Dimensions

2x3/2-way, 5/2-way and 5/3-way valve

Download CAD data → www.festo.com

⌀ - Note
More dimensions
Connecting plates
→ page 103

1 Vertical electrical connection

2 Horizontal electrical connection

3 Manual override

Type	B1	H1	H2	L1	L2	L3	L4	L5	L6	L7
VUVG-B10 -...-F ...	10.2	32.5	3.6	86.5	81.5	8	4.85	6.15	69.2	66.7

Solenoid valves VUVG-B10, sub-base valves

Ordering data

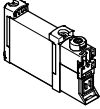
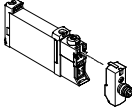
Ordering data					
	Description		Part No.	Type	
Sub-base valve M5/M7, without connecting plate					
	2x3/2-way valve				
	External pilot air supply	Normally closed, reset method: pneumatic spring		566487	VUVG-B10-T32C-AZT-F-1P3
		Normally open, reset method: pneumatic spring		566488	VUVG-B10-T32U-AZT-F-1P3
		1x normally open, 1x normally closed, reset method: pneumatic spring		566489	VUVG-B10-T32H-AZT-F-1P3
		Normally closed, reset method: mechanical spring		574364	VUVG-B10-T32C-MZT-F-1P3
		Normally open, reset method: mechanical spring		574365	VUVG-B10-T32U-MZT-F-1P3
		1x normally open, 1x normally closed, reset method: mechanical spring		574366	VUVG-B10-T32H-MZT-F-1P3
	5/2-way valve, single solenoid				
	External pilot air supply	Reset method: pneumatic/mechanical spring		566490	VUVG-B10-M52-RZT-F-1P3
		Reset method: mechanical spring		574367	VUVG-B10-M52-MZT-F-1P3
	5/2-way valve, double solenoid				
	External pilot air supply			566491	VUVG-B10-B52-ZT-F-1P3
	5/3-way valve				
	External pilot air supply	Mid-position closed		566492	VUVG-B10-P53C-ZT-F-1P3
Mid-position exhausted			566493	VUVG-B10-P53E-ZT-F-1P3	
Mid-position pressurised			566494	VUVG-B10-P53U-ZT-F-1P3	
Sub-base valve M5/M7, with E-box R8					
	2x3/2-way valve				
	External pilot air supply	Normally closed, reset method: pneumatic spring		574234	VUVG-B10-T32C-AZT-F-1R8L
		Normally open, reset method: pneumatic spring		574235	VUVG-B10-T32U-AZT-F-1R8L
		1x normally open, 1x normally closed, reset method: pneumatic spring		574236	VUVG-B10-T32H-AZT-F-1R8L
		Normally closed, reset method: mechanical spring		8031492	VUVG-B10-T32C-MZT-F-1R8L
		Normally open, reset method: mechanical spring		8031493	VUVG-B10-T32U-MZT-F-1R8L
		1x normally open, 1x normally closed, reset method: mechanical spring		8031494	VUVG-B10-T32H-MZT-F-1R8L
	5/2-way valve, single solenoid				
	External pilot air supply	Reset method: pneumatic/mechanical spring		574237	VUVG-B10-M52-RZT-F-1R8L
		Reset method: mechanical spring		578157	VUVG-B10-M52-MZT-F-1R8L
	5/2-way valve, double solenoid				
	External pilot air supply			574238	VUVG-B10-B52-ZT-F-1R8L
	5/3-way valve				
	External pilot air supply	Mid-position closed		574239	VUVG-B10-P53C-ZT-F-1R8L
		Mid-position exhausted		574241	VUVG-B10-P53E-ZT-F-1R8L
		Mid-position pressurised		574240	VUVG-B10-P53U-ZT-F-1R8L

Solenoid valves VUVG-B10, sub-base valves

FESTO

Ordering data

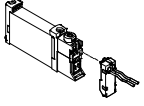
Ordering data				
		Description	Part No.	Type
Sub-base valve M5/M7, with E-box H2				
	2x3/2-way valve			
	External pilot air supply	Normally closed, reset method: pneumatic spring	578165	VUVG-B10-T32C-AZT-F-1H2L-W1
	5/2-way valve, single solenoid			
	External pilot air supply	Reset method: mechanical spring	578167	VUVG-B10-M52-MZT-F-1H2L-W1
	5/2-way valve, double solenoid			
	External pilot air supply		578169	VUVG-B10-B52-ZT-F-1H2L-W1
	5/3-way valve			
External pilot air supply	Mid-position closed	578171	VUVG-B10-P53C-ZT-F-1H2L-W1	

Solenoid valves VUVG-B10, sub-base valves M5/M7

Manifold assembly

Sub-base valve for manifold assembly
M5 or M7 connection



Dimensions

Download CAD data → www.festo.com

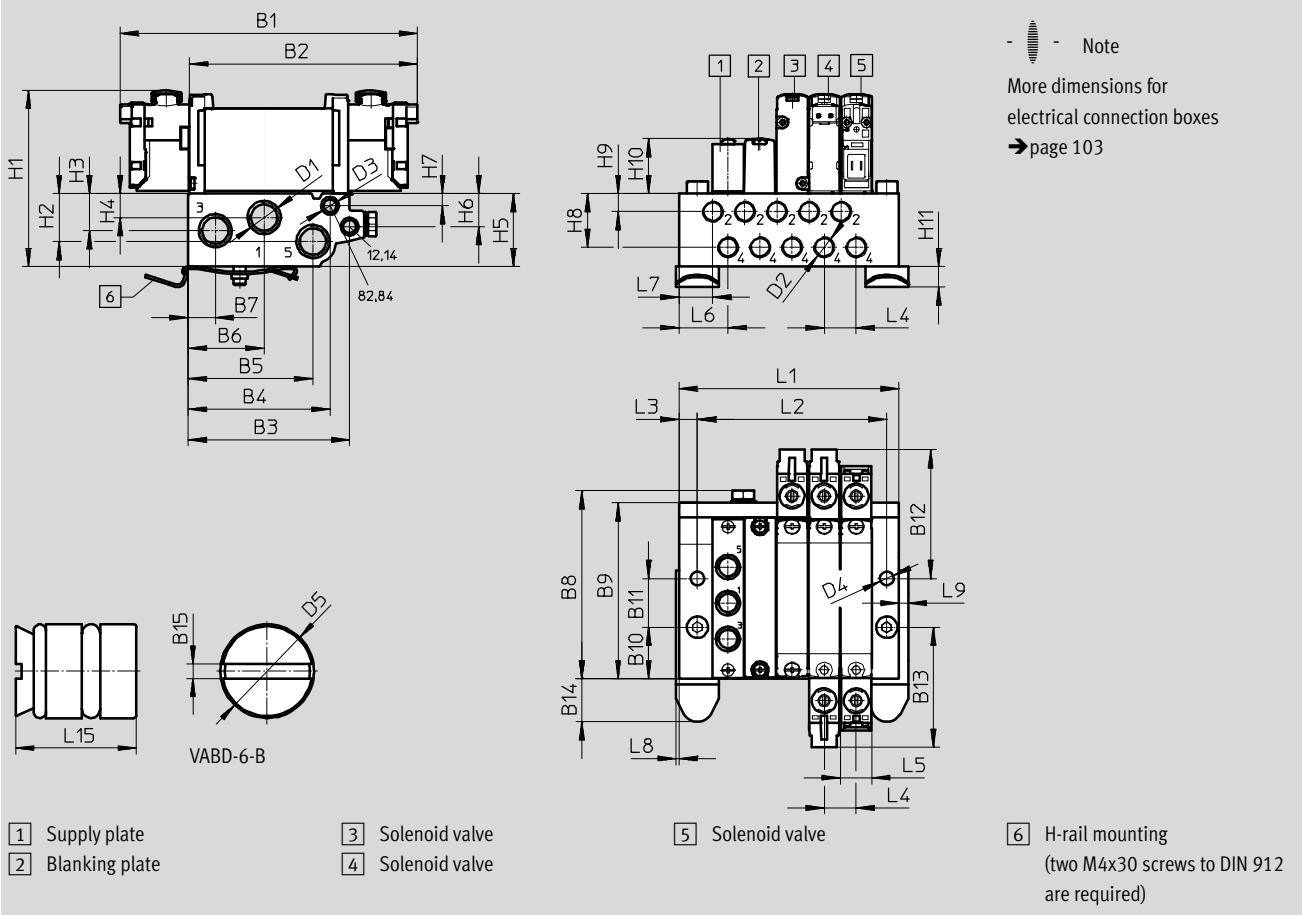

Type	B1	B2	B3	B4	B5	B6	B7	B8	B9	B10	B11	B12
VUVG-B10 -...-F- ...	97.5	74.8	52.9	46.5	40.9	24.9	8.9	62	57.7	16.9	16	42.2

Type	B13	B14	B15	D1	D2	D3	D4	D5	H1	H2	H3	H4
VUVG-B10 -...-F- ...	39.3	14.05	1.2	G1/8	M5/M7	M5	4.5	∅ 6	56.4	15.7	12.17	7.87

Type	H5	H6	H7	H8	H9	H10	H11	L3	L4	L5	L6	L7	L8	L9	L15
VUVG-B10 -...-F- ...	23.9	10.8	4	17.6	5.9	18	6.8	4	10.5	10.2	16	11	1	3	10

Solenoid valves VUVG-B10, sub-base valves M5/M7

Manifold assembly

Valve positions	2	3	4	5	6	7	8	9	10	12	14	16	22
L1 [mm]	40.5	51	61.5	72	82.5	93	103.5	114	124.5	145.5	166.5	187.5	250.5
L2 [mm]	30.5	41	51.5	62	72.5	83	93.5	104	114.5	135.5	156.5	177.5	240.5
VABM weight [g]	107	135	163	191	219	247	275	303	331	387	415	471	499

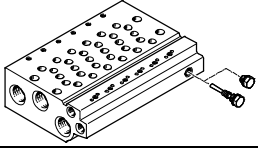
Technical data – Manifold rails ¹⁾									
	Connection			CRC	Material ³⁾	Operating pressure [bar]	Max. tightening torque for assembly [Nm]		
	2, 4	1, 3, 5	12/14, 82/84				Valve	H-rail	Wall
	M5 or M7	G1/8	M5	2 ²⁾	Wrought aluminium alloy	-0.9 ... 10	0.45	1.5	3

- 1) Blanking plugs are included with the manifold rail.
- 2) Corrosion resistance class 2 according to Festo standard 940 070
Components subject to moderate corrosion stress. External visible parts with primarily decorative surface requirements which are in direct contact with the surrounding industrial environment or media such as coolants or lubricating agents.
- 3) Note on materials: RoHS compliant.

Order code – Manifold rails



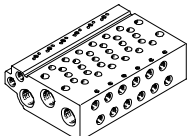

VABM	-	L1	-	10	-	G18	-	
Valve manifold parts								Number of valve positions
Manifold rail		VABM						2 to 10, 12, 14 and 16
Valve series								Port 1, 3, 5
VUVG		L1				G18		G1/8 thread
Valve size								
10 mm				10				
Manifold rail with port 1, 2, 3, 4, 5, 12/14, 82/84								
Port 2 and 4 with M5 thread								
W								
Port 2 and 4 with M7 thread								
HW								

Ordering data – Manifold rails

	Description	Part No.	Type
	Manifold rail for sub-base valve M5/M7 For size B10 (M5)	2 valve positions	566582 VABM-L1-10W-G18-2
		3 valve positions	566583 VABM-L1-10W-G18-3
		4 valve positions	566584 VABM-L1-10W-G18-4
		5 valve positions	566585 VABM-L1-10W-G18-5
		6 valve positions	566586 VABM-L1-10W-G18-6
		7 valve positions	566587 VABM-L1-10W-G18-7
		8 valve positions	566588 VABM-L1-10W-G18-8
		9 valve positions	566589 VABM-L1-10W-G18-9
		10 valve positions	566590 VABM-L1-10W-G18-10
		12 valve positions	566591 VABM-L1-10W-G18-12
		14 valve positions	566592 VABM-L1-10W-G18-14
		16 valve positions	566593 VABM-L1-10W-G18-16

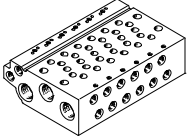

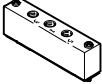
Solenoid valves VUVG-B10, sub-base valves M5/M7

Manifold assembly

Ordering data – Accessories			
	Description	Part No.	Type
Manifold rail for sub-base valve M5/M7			
	For size B10 (M7)	2 valve positions	566606 VABM-L1-10HW-G18-2
		3 valve positions	566607 VABM-L1-10HW-G18-3
		4 valve positions	566608 VABM-L1-10HW-G18-4
		5 valve positions	566609 VABM-L1-10HW-G18-5
		6 valve positions	566610 VABM-L1-10HW-G18-6
		7 valve positions	566611 VABM-L1-10HW-G18-7
		8 valve positions	566612 VABM-L1-10HW-G18-8
		9 valve positions	566613 VABM-L1-10HW-G18-9
		10 valve positions	566614 VABM-L1-10HW-G18-10
		12 valve positions	566615 VABM-L1-10HW-G18-12
		14 valve positions	566616 VABM-L1-10HW-G18-14
16 valve positions	566617 VABM-L1-10HW-G18-16		
Blanking plate Technical data → Internet: vabb			
	For manifold rail 10W/10HW, sub-base valves	Incl. screws and seal	566495 VABB-L1-10-W
Separator Technical data → Internet: vabd			
	For manifold rail 10W and 10HW, sub-base valves	Separator for pressure zones	569994 VABD-6-B
Supply plate Technical data → Internet: vabf			
	For manifold rail 10W	Incl. screws and seal	569991 VABF-L1-10-P3A4-M5
	For manifold rail 10HW		569992 VABF-L1-10-P3A4-M7
Seals Technical data → Internet: vabd			
	For sub-base valves B10	Delivery unit: 10 sets (each with 2 screws and 1 seal)	566674 VABD-L1-10B-S-M7

Solenoid valves VUVG, sub-base valves G1/8

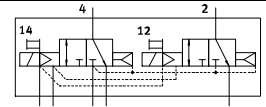
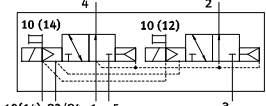
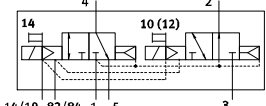
Order code

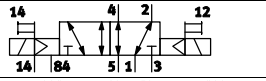
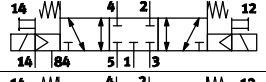
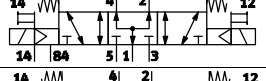
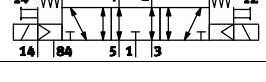
VUVG	-	B	14	-	-	-	Z	
Valve type								
Sub-base, manifold valve incl. seal and screws		B						
Design principle								
Piston spool with sealing cartridge		-						
Piston spool with sealing ring		K						
Valve size								
14 mm		14						
Valve functions								
		T32C						
		T32U						
		T32H						
		M52						
		B52						
		P53C						
		P53U						
		P53E						
Reset method								
Pneumatic spring with T32 and M52		A						
Mechanical spring with T32 and M52		M						
With B52 and P53		-						
Pilot air supply port								
External		Z						
Manual override								
Non-detenting		H						
Covered		S						
Non-detenting, detenting		T						
Detenting, without accessories		Y						

F	-	-	-	L	-	-	-	-
Version								
- Extended features								
S Focused features								
Connecting cables								
W1...4		Not sheathed						
C1...4		Sheathed						
WS1...4		Not sheathed						
S1...4		Sheathed						
N1...4		M8x1, 3-pin						
N5...8		M8x1, 4-pin						
Display								
L LED								
Protective circuit								
- Without holding current reduction (HCR)								
R With holding current reduction (HCR)								
Electrical connection box								
H2		Connection pattern H, horizontal plug connector						
H3		Connection pattern H, vertical plug connector						
S2		Connection pattern S, horizontal plug connector						
S3		Connection pattern S, vertical plug connector						
L1...4		With 2x flying leads L: 1 = 0.5 m, 2 = 1 m, 3 = 2.5 m, 4 = 5 m						
K6...9		Cable: K6 = 0.5 m, K7 = 1 m, K8 = 2.5 m, K9 = 5 m						
R1		Individual plug connector M8, 4-pin						
R8		Individual plug connector M8, 3-pin						
P3		Without electrical connection box						
Operating voltage								
1		24 V DC						
5		12 V DC						
4		5 V DC						
Pneumatic port								
F		In the manifold rail						



Solenoid valves VUVG-BK14, sub-base valves G1/8

Technical data

Function
2x3/2C

5/2-way, single solenoid
5/2-way, double solenoid

Circuit symbol → page 11

-  - Valve size 14 mm
-  - Flow rate
350 ... 380 l/min
-  - Voltage
24 V DC

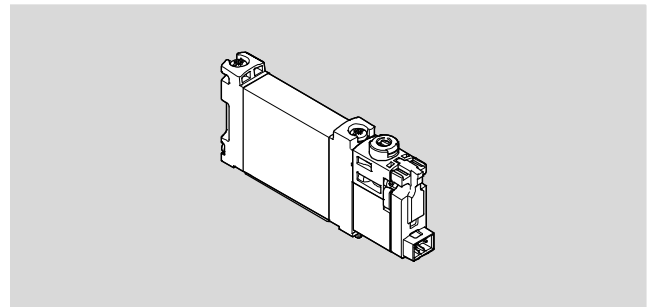

General technical data VUVG-BK G1/8			
Valve function	T32-A	M52-A	B52
Normal position	C ¹⁾	–	–
Stable positions	Monostable		Bistable
Reset method: pneumatic spring	Yes	Yes	–
Design	Piston spool		
Sealing principle	Soft		
Type of actuation	Electrical		
Type of piloting	Piloted		
Pilot air supply	Internal		
Exhaust air function	With flow control		
Manual override	Non-detenting, detenting		
Type of mounting	On manifold rail		
Mounting position	Any		
Standard nominal flow rate	[l/min]	350	380
Switching time on/off	[ms]	13/20	14/24
Changeover time	[ms]	–	8
Valve size	[mm]	14	
Port	2, 4	G1/8 in manifold rail	
Product weight	[g]	75	85
Corrosion resistance class CRC ²⁾	2		

1) C=Normally closed.

2) Corrosion resistance class 2 to Festo standard 940 070

Components subject to moderate corrosion stress. External visible parts with primarily decorative surface requirements which are in direct contact with the surrounding industrial environment or media such as coolants or lubricating agents.

Safety data	
Note on forced checking procedure	Switching frequency min. 1/week
Max. positive test pulse with 0 signal	[μs] 1600
Max. negative test pulse with 1 signal	[μs] 3000
Resistance to shocks	Shock test with severity level 1 to FN 942017-5 and EN 60068-2-27
Vibration resistance	Transport application test with severity level 1 to FN 942017-4 and EN 60068-2-6

Solenoid valves VUVG-BK14, sub-base valves G1/8

Technical data

Operating and environmental conditions			
Valve function		T32-A ¹⁾	M52-A ¹⁾
Operating medium		Compressed air in accordance with ISO 8573-2010 [7:4:4]	
Note on operating/pilot medium		Lubricated operation possible (in which case lubricated operation will always be required)	
Operating pressure	[bar]	1.5 ... 7	1.5 ... 7
Ambient temperature	[°C]	-5 ... +50	
Temperature of medium	[°C]	-5 ... +50	

1) Pneumatic spring

Electrical data	
Electrical connection	Via connecting plate
Operating voltage	[V DC] 24 ±10%
Nominal operating voltage	[V DC] 22
Power	[W] 0.7
Duty cycle	[%] 100
Degree of protection to EN 60529	IP40 (with plug socket), IP65/IP67 (with M8)
Signal status display	LED
Maximum switching frequency	[Hz] 2

Information on materials	
Housing	Wrought aluminium alloy
Seals	HNBR, NBR
Note on materials	RoHS compliant Contains PWIS (paint-wetting impairment substances)

Dimensions Download CAD data → www.festo.com

2x 3/2-way, 5/2-way valve, single solenoid 5/2-way valve, double solenoid

- - Note
More dimensions for electrical connection boxes
→ page 103

2

 Horizontal electrical connection

3

 Manual override

Type	B1	H1	L1	L2	L7
VUVG-BK14-T32C-...	14.4	34.8	118.9	116.4	66.5
VUVG-BK14-B52-...			95.6		
VUVG-BK14-M52-...				94.4	

Solenoid valves VUVG-BK14, sub-base valves G1/8

FESTO

Ordering data

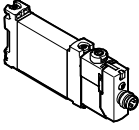
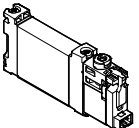
Ordering data			
	Description	Part No.	Type
Sub-base valve G1/8, with electrical connection box R8			
	2x3/2-way valve		
	External pilot air supply	Normally closed, reset method: pneumatic spring	8042574 VUVG-BK14-T32C-AT-F-1R8L-S
	5/2-way valve, single solenoid		
	External pilot air supply	Reset method: pneumatic spring	8042575 VUVG-BK14-M52-AT-F-1R8L-S
	5/2-way valve, double solenoid		
	External pilot air supply		8042576 VUVG-BK14-B52-T-F-1R8L-S
Sub-base valve G1/8, with electrical connection box H2			
	2x3/2-way valve		
	External pilot air supply	Normally closed, reset method: pneumatic spring	8042570 VUVG-BK14-T32C-AT-F-1H2L-S
	5/2-way valve, single solenoid		
	External pilot air supply	Reset method: pneumatic spring	8042571 VUVG-BK14-M52-AT-F-1H2L-S
	5/2-way valve, double solenoid		
	External pilot air supply		8042572 VUVG-BK14-B52-T-F-1H2L-S

Solenoid valves VUVG-B14, sub-base valves





Technical data

Function

2x3/2C, 2x3/2U, 2x3/2H
5/2-way, single solenoid
5/2-way, double solenoid
5/3C, 5/3U, 5/3E

Circuit symbol → page 11

-  - Width 14 mm
-  - Flow rate
410 ... 580 l/min
-  - Voltage
5, 12 and 24 V DC

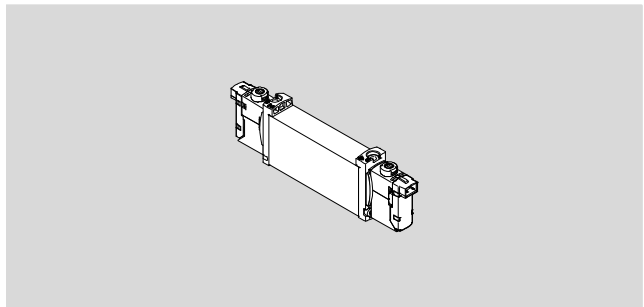

General technical data												
Valve function	T32-A			T32-M			M52-A	B52	M52-M	P53		
Normal position	C ¹⁾	U ²⁾	H ⁴⁾	C ¹⁾	U ²⁾	H ⁴⁾	-	-	-	C ¹⁾	U ²⁾	E ³⁾
Stable position	Single solenoid							Double solenoid	Single solenoid	Single solenoid		
Reset method: pneumatic spring	Yes			No			Yes	-	No	No		
Reset method: mechanical spring	No			Yes			No	-	Yes	Yes		
Vacuum operation at port 1	No			Only with external pilot air supply								
Design	Piston spool valve											
Sealing principle	Soft											
Actuation type	Electrical											
Type of pilot control	Piloted											
Pilot air supply	External, internal; can be selected via sub-base											
Exhaust function	With flow control											
Manual override	Choice of non-detenting, covered, non-detenting/detenting or detenting											
Type of mounting	On manifold rail											
Mounting position	Any											
Nominal size [mm]	4.6			4.3			5.4					
Nominal flow rate [l/min]	600	580		470	450	450	630	680		600	580	580
Flow rate on manifold rail G ¹ / ₈ [l/min]	540	510	540	430	410	410	520	580		540	510	510
Switching time on/off [ms]	8/23			11/15			14/22		-	13/35		12/40
Changeover time [ms]	-							8				20
Width [mm]	14											
Port	1, 3, 5		G ¹ / ₄ in manifold rail									
	2, 4		G ¹ / ₈ in manifold rail									
	12/14, 82/84		M5 in manifold rail									
Product weight [g]	89			80			78	89	70	89		
Approval	c UL us - Recognized (OL)											
	c CSA us (OL)											
CE marking (see declaration of conformity)	To EU EMC Directive ⁵⁾											
Corrosion resistance class CRC ⁶⁾	2											

1) C=Normally closed/mid-position closed

2) U=Normally open/mid-position pressurised

3) E=Mid-position exhausted

4) H=2x 3/2-way valve in one housing with 1x normally closed and 1x normally open

5) For information about the applicability of the component see the manufacturer's EC declaration of conformity at: www.festo.com/sp → Certificates.

If the component is subject to restrictions on usage in residential, office or commercial environments or small businesses, further measures to reduce the emitted interference may be necessary.

6) Corrosion resistance class 2 according to Festo standard 940 070

Components subject to moderate corrosion stress. Externally visible parts with primarily decorative surface requirements which are in direct contact with a normal industrial environment or media such as coolants or lubricating agents.

Solenoid valves VUVG-B14, sub-base valves

Technical data

Operating and environmental conditions									
Valve function			T32-A ¹⁾	T32-M ²⁾	M52-A ¹⁾	B52	M52-M ²⁾	P53	
Operating medium			Compressed air in accordance with ISO 8573-2010 [7:4:4]						
Operating pressure	Internal	[bar]	1.5 ... 8	3 ... 8	2.5 ... 8	1.5 ... 8	3 ... 8		
	External	[bar]	1.5 ... 10	-0.9 ... 10			-0.9 ... 8	-0.9 ... 10	
Pilot pressure ³⁾		[bar]	1.5 ... 8	2 ... 8	2.5 ... 8	1.5 ... 8	3 ... 8		
Ambient temperature		[°C]	-5 ... +50, -5 ... +60 with holding current reduction						
Temperature of medium		[°C]	-5 ... +50, -5 ... +60 with holding current reduction						

- 1) Pneumatic spring
- 2) Mechanical spring
- 3) Minimum pilot pressure 50% of operating pressure

Electrical data	
Electrical connection	Via connecting plate
Operating voltage	[V DC] 5, 12 and 24 ±10%
Power	[W] 1, reduced to 0.35 with holding current reduction
Duty cycle ED	[%] 100
Degree of protection to EN 60529	IP40 (with plug socket), IP65 (with M8)

Information on materials	
Housing	Wrought aluminium alloy
Seals	HNBR, NBR
Note on materials	RoHS compliant

Dimensions Download CAD data → www.festo.com

2x3/2-way, 5/2-way and 5/3-way valve

1 Horizontal electrical connection 2 Manual override

Type	B1	H1	L1	L2	L3	L4	L5	L6	L7	L8
VUVG-B14 -...-F ...	14.4	34.8	107	102	8	66.5	4.85	6.15	89.45	86.95

Solenoid valves VUVG-B14, sub-base valves

Ordering data

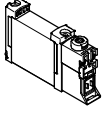
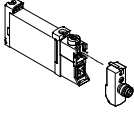
Ordering data				
Description		Part No.	Type	
Sub-base valve G $\frac{1}{8}$, without connecting plate				
	2x3/2-way valve			
	External pilot air supply	Normally closed, reset method: pneumatic spring	566513	VUVG-B14-T32C-AZT-F-1P3
		Normally open, reset method: pneumatic spring	566514	VUVG-B14-T32U-AZT-F-1P3
		1x normally open, 1x normally closed, reset method: pneumatic spring	566515	VUVG-B14-T32H-AZT-F-1P3
		Normally closed, reset method: mechanical spring	574376	VUVG-B14-T32C-MZT-F-1P3
		Normally open, reset method: mechanical spring	574377	VUVG-B14-T32U-MZT-F-1P3
		1x normally open, 1x normally closed, reset method: mechanical spring	574378	VUVG-B14-T32H-MZT-F-1P3
	5/2-way valve, single solenoid			
	External pilot air supply	Reset method: pneumatic spring	566516	VUVG-B14-M52-AZT-F-1P3
		Reset method: mechanical spring	574379	VUVG-B14-M52-MZT-F-1P3
	5/2-way valve, double solenoid			
	External pilot air supply		566517	VUVG-B14-B52-ZT-F-1P3
	5/3-way valve			
	External pilot air supply	Mid-position closed	566518	VUVG-B14-P53C-ZT-F-1P3
Mid-position exhausted		566519	VUVG-B14-P53E-ZT-F-1P3	
Mid-position pressurised		566520	VUVG-B14-P53U-ZT-F-1P3	
Sub-base valve G $\frac{1}{8}$, with E-box R8				
	2x3/2-way valve			
	External pilot air supply	Normally closed, reset method: pneumatic spring	574242	VUVG-B14-T32C-AZT-F-1R8L
		Normally open, reset method: pneumatic spring	574243	VUVG-B14-T32U-AZT-F-1R8L
		1x normally open, 1x normally closed, reset method: pneumatic spring	574244	VUVG-B14-T32H-AZT-F-1R8L
		Normally closed, reset method: mechanical spring	578248	VUVG-B14-T32C-MZT-F-1R8L
		Normally open, reset method: mechanical spring	8031517	VUVG-B14-T32U-MZT-F-1R8L
		1x normally open, 1x normally closed, reset method: mechanical spring	8031518	VUVG-B14-T32H-MZT-F-1R8L
	5/2-way valve, single solenoid			
	External pilot air supply	Reset method: pneumatic spring	574245	VUVG-B14-M52-AZT-F-1R8L
		Reset method: mechanical spring	578158	VUVG-B14-M52-MZT-F-1R8L
	5/2-way valve, double solenoid			
	External pilot air supply		574246	VUVG-B14-B52-ZT-F-1R8L
	5/3-way valve			
	External pilot air supply	Mid-position closed	574247	VUVG-B14-P53C-ZT-F-1R8L
		Mid-position exhausted	574249	VUVG-B14-P53E-ZT-F-1R8L
		Mid-position pressurised	574248	VUVG-B14-P53U-ZT-F-1R8L

Solenoid valves VUVG-B14, sub-base valves

FESTO

Ordering data

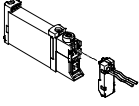
Ordering data				
	Description		Part No.	Type
Sub-base valve G $\frac{1}{8}$, with E-box H2				
	2x3/2-way valve			
	External pilot air supply	Normally closed, reset method: pneumatic spring	578166	VUVG-B14-T32C-AZT-F-1H2L-W1
	5/2-way valve, single solenoid			
	External pilot air supply	Reset method: mechanical spring	578168	VUVG-B14-M52-MZT-F-1H2L-W1
	5/2-way valve, double solenoid			
	External pilot air supply		578170	VUVG-B14-B52-ZT-F-1H2L-W1
	5/3-way valve			
External pilot air supply	Mid-position closed	578172	VUVG-B14-P53C-ZT-F-1H2L-W1	

Solenoid valves VUVG-B14, sub-base valves G1/8

Manifold assembly



Sub-base valve for manifold assembly
G1/8 connection

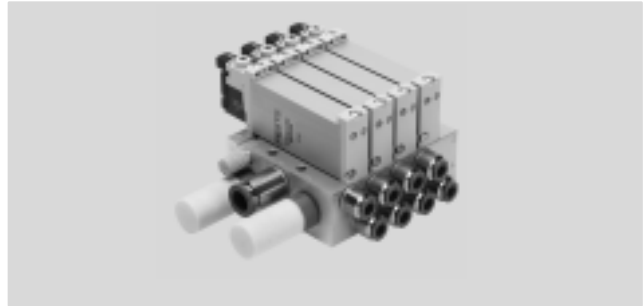

Dimensions

Download CAD data → www.festo.com

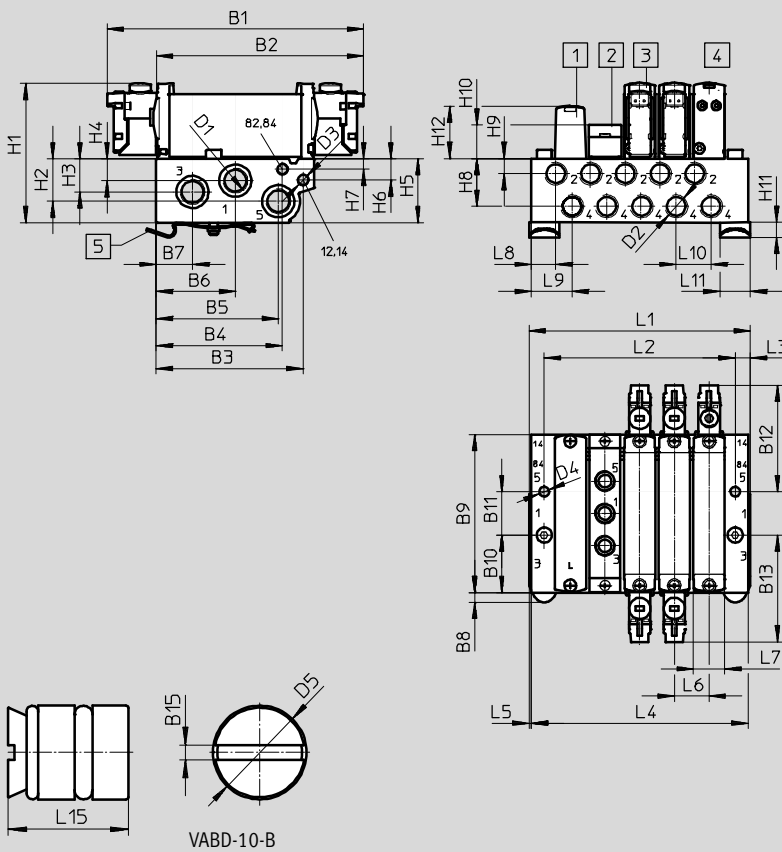

Note
More dimensions for electrical connection boxes
→ page 103

- 1 Blanking plate
- 2 Supply plate
- 3 Double solenoid valve
- 4 Single solenoid valve
- 5 H-rail mounting (two M4x25 screws to DIN 912 are required)

Type	B1	B2	B3	B4	B5	B6	B7	B8	B9	B10	B11	B12
VUVG-B14 -...-F- ...	118.3	95.1	67.7	58.2	56.3	36.6	16.7	4.5	72.9	26.5	20	49.1

Type	B13	B15	D1	D2	D3	D4	D5	H1	H2	H3	H4	H5
VUVG-B14 -...-F- ...	49.1	1.2	G1/4	G1/8	M5	∅ 4.5	∅ 9.8	64.3	19.6	15.3	10.1	29.5

Type	H6	H7	H8	H9	H10	H11	H12	L3	L5	L6	L7	L8	L9	L10	L11
VUVG-B14 -...-F- ...	9.83	4.8	22.1	7	15.4	6.8	23.9	6	1	16	14.4	13.6	21.1	16	14

Solenoid valves VUVG-B14, sub-base valves G1/8

Ordering data

Valve positions	2	3	4	5	6	7	8	9	10	12	14	16
L1 [mm]	56.3	72.3	88.3	104.3	120.3	136.3	152.3	168.3	184.3	216.3	248.3	280.3
L2 [mm]	40	56	72	88	104	120	136	152	168	200	232	264
L4 [mm]	54.3	70.3	86.3	102.3	118.3	134.3	150.3	166.3	182.3	214.3	246.6	278.3
VABM weight [g]	232	306	380	454	528	602	676	750	824	972	1120	1268

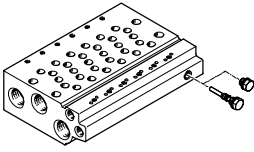
Technical data – Manifold rails ¹⁾									
	Connection			CRC	Material ³⁾	Operating pressure [bar]	Max. tightening torque for assembly [Nm]		
	2, 4	1, 3, 5	12/14, 82/84				Valve	H-rail	Wall
	G1/8	G1/4	M5	2 ²⁾	Wrought aluminium alloy	-0.9 ... 10	0.65	1.5	3

- 1) Blanking plugs are included with the manifold rail.
- 2) Corrosion resistance class 2 according to Festo standard 940 070
Components subject to moderate corrosion stress. Externally visible parts with primarily decorative surface requirements which are in direct contact with the surrounding industrial environment or media such as coolants or lubricating agents.
- 3) Note on materials: RoHS compliant.

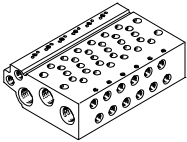

Order code – Manifold rails

VABM	-	L1	-	14	W	-	G14	-	
Valve manifold parts									Number of valve positions
Manifold rail		VABM							2 to 10, 12, 14 and 16
Valve series									Port 1, 3, 5
VUVG		L1					G14		G1/4 thread
Valve size									
14 mm					14				
Manifold rail with port 1, 2, 3, 4, 5, 12/14, 82/84									
Port 2 and 4 with thread G1/8									
									W

Ordering data – Manifold rail			
	Description	Part No.	Type
Manifold rail for sub-base valve G1/8			
	For size B14 (G1/8)	2 valve positions	566642 VABM-L1-14W-G14-2
		3 valve positions	566643 VABM-L1-14W-G14-3
		4 valve positions	566644 VABM-L1-14W-G14-4
		5 valve positions	566645 VABM-L1-14W-G14-5
		6 valve positions	566646 VABM-L1-14W-G14-6
		7 valve positions	566647 VABM-L1-14W-G14-7
		8 valve positions	566648 VABM-L1-14W-G14-8
		9 valve positions	566649 VABM-L1-14W-G14-9
		10 valve positions	566650 VABM-L1-14W-G14-10
		12 valve positions	566651 VABM-L1-14W-G14-12
14 valve positions	566652 VABM-L1-14W-G14-14		
16 valve positions	566653 VABM-L1-14W-G14-16		

Solenoid valves VUVG-B14, sub-base valves G1/8

Ordering data

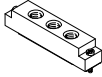
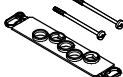
Ordering data – Accessories			
	Description	Part No.	Type
Blanking plate Technical data → Internet: vabb			
	For manifold rail 14W, sub-base valves	Incl. screws and seal 569989	VABB-L1-14
Separator Technical data → Internet: vabd			
	For manifold rail 14W, sub-base valves	Separator for pressure zones 569996	VABD-10-B
Supply plate Technical data → Internet: vabf			
	For manifold rail 14W	Incl. screws and seal 569993	VABF-L1-14-P3A4-G18
Seals Technical data → Internet: vabd			
	For sub-base valves B14	Delivery unit: 10 sets (each with 2 screws and 1 seal) 566676	VABD-L1-14B-S-G18



Solenoid valves VUVG-B18, sub-base valves

Technical data

Function

2x3/2C, 2x3/2U, 2x3/2H
 5/2-way, single solenoid
 5/2-way, double solenoid
 5/3C, 5/3U, 5/3E

Circuit symbol → page 11

-  - Width 18 mm
-  - Flow rate
800 ... 1080 l/min
-  - Voltage
5, 12 and 24 V DC



General technical data												
Valve function	T32-A			T32-M			M52-R	B52	M52-M	P53		
Normal position	C ¹⁾	U ²⁾	H ⁴⁾	C ¹⁾	U ²⁾	H ⁴⁾	–	–	–	C ¹⁾	U ²⁾	E ³⁾
Stable position	Single solenoid						Double solenoid	Single solenoid	Single solenoid			
Reset method: pneumatic spring	Yes			No			Yes ⁵⁾	–	No	No		
Reset method: mechanical spring	No			Yes			Yes ⁵⁾	–	Yes	Yes		
Vacuum operation at port 1	No			Only with external pilot air supply								
Design	Piston spool valve											
Sealing principle	Soft											
Actuation type	Electrical											
Type of control	Piloted											
Pilot air supply	External, internal; can be selected via sub-base											
Exhaust function	With flow control											
Manual override	Choice of non-detenting, covered, non-detenting/detenting or detenting											
Type of mounting	On manifold rail											
Mounting position	Any											
Nominal size [mm]	5.7			6.9			7.3	6.9		6.5		
Nominal flow rate [l/min]	900			1150					1080			
Flow rate on manifold rail	800			1000					950			
Switching time on/off [ms]	13/27			15/22			15/31	–	10/45		15/48	
Changeover time [ms]	–						11		29			
Width [mm]	18											
Port	1, 3, 5			G $\frac{3}{8}$ in manifold rail								
	2, 4			G $\frac{1}{4}$ in manifold rail								
	12/14, 82/84			M5 in manifold rail								
Product weight [g]	164			154			160	154		160		
Approval	c UL us - Recognized (OL)											
	c CSA us (OL)											
CE marking (see declaration of conformity)	To EU EMC Directive ⁶⁾											
Corrosion resistance class CRC ⁷⁾	2											

1) C=Normally closed/mid-position closed
 2) U=Normally open/mid-position pressurised
 3) E=Mid-position exhausted
 4) H=2x 3/2-way valve in one housing with 1x normally closed and 1x normally open
 5) Combined reset method
 6) For information about the applicability of the component see the manufacturer's EC declaration of conformity at: www.festo.com/sp → Certificates.
 If the component is subject to restrictions on usage in residential, office or commercial environments or small businesses, further measures to reduce the emitted interference may be necessary.
 7) Corrosion resistance class 2 according to Festo standard 940 070
 Components subject to moderate corrosion stress. Externally visible parts with primarily decorative surface requirements which are in direct contact with a normal industrial environment or media such as coolants or lubricating agents.

Solenoid valves VUVG-B18, sub-base valves

Technical data

Operating and environmental conditions							
Valve function			T32-A ¹⁾	T32-M ³⁾	M52-R ²⁾	B52	M52-M ³⁾ P53
Operating medium		Compressed air in accordance with ISO 8573-2010 [7:4:4]					
Operating pressure	Internal	[bar]	1.5 ... 8	3.5 ... 8	2.5 ... 8	1.5 ... 8	3 ... 8
	External	[bar]	1.5 ... 10	-0.9 ... 10			-0.9 ... 8
Pilot pressure ⁴⁾		[bar]	1.5 ... 8	3 ... 8	2.5 ... 8	1.5 ... 8	3 ... 8
Ambient temperature		[°C]	-5 ... +50, -5 ... +60 with holding current reduction				
Temperature of medium		[°C]	-5 ... +50, -5 ... +60 with holding current reduction				

- 1) Pneumatic spring
- 2) Mixed, pneumatic/mechanical spring
- 3) Mechanical spring
- 4) Minimum pilot pressure 50% of operating pressure

Electrical data	
Electrical connection	Via connecting plate
Operating voltage	[V DC] 5, 12 and 24 ±10%
Power	[W] 1, reduced to 0.35 with holding current reduction
Duty cycle ED	[%] 100
Degree of protection to EN 60529	IP40 (with plug socket), IP65 (with M8)

Information on materials	
Housing	Wrought aluminium alloy
Seals	HNBR, NBR
Note on materials	RoHS compliant

Dimensions Download CAD data → www.festo.com

2x3/2-way, 5/2-way and 5/3-way valve

⌀ - Note
More dimensions
Connecting plates
→ page 103

1 Horizontal electrical connection 2 Manual override

Type	B1	H1	L1	L2	L3	L4	L5
VUVG-B18 -...-F ...	18.3	43.1	129.4	124.4	86.4	112.2	109.7

Solenoid valves VUVG-B18, sub-base valves

Ordering data

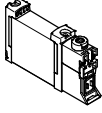
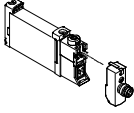
Ordering data				
Description		Part No.	Type	
Sub-base valve G $\frac{1}{4}$, without connecting plate				
	2x3/2-way valve			
	External pilot air supply	Normally closed, reset method: pneumatic spring	574443	VUVG-B18-T32C-AZT-F-1P3
		Normally open, reset method: pneumatic spring	574444	VUVG-B18-T32U-AZT-F-1P3
		1x normally open, 1x normally closed, reset method: pneumatic spring	574445	VUVG-B18-T32H-AZT-F-1P3
		Normally closed, reset method: mechanical spring	574446	VUVG-B18-T32C-MZT-F-1P3
		Normally open, reset method: mechanical spring	574447	VUVG-B18-T32U-MZT-F-1P3
		1x normally open, 1x normally closed, reset method: mechanical spring	574448	VUVG-B18-T32H-MZT-F-1P3
	5/2-way valve, single solenoid			
	External pilot air supply	Reset method: pneumatic/mechanical spring	574449	VUVG-B18-M52-RZT-F-1P3
		Reset method: mechanical spring	574450	VUVG-B18-M52-MZT-F-1P3
	5/2-way valve, double solenoid			
	External pilot air supply		574451	VUVG-B18-B52-ZT-F-1P3
	5/3-way valve			
External pilot air supply	Mid-position closed	574452	VUVG-B18-P53C-ZT-F-1P3	
	Mid-position exhausted	574453	VUVG-B18-P53E-ZT-F-1P3	
	Mid-position pressurised	574454	VUVG-B18-P53U-ZT-F-1P3	
Sub-base valve G $\frac{1}{4}$, with E-box R8				
	2x3/2-way valve			
	External pilot air supply	Normally closed, reset method: pneumatic spring	8031537	VUVG-B18-T32C-AZT-F-1R8L
		Normally open, reset method: pneumatic spring	8031538	VUVG-B18-T32U-AZT-F-1R8L
		1x normally open, 1x normally closed, reset method: pneumatic spring	8031539	VUVG-B18-T32H-AZT-F-1R8L
		Normally closed, reset method: mechanical spring	8031540	VUVG-B18-T32C-MZT-F-1R8L
		Normally open, reset method: mechanical spring	8031541	VUVG-B18-T32U-MZT-F-1R8L
		1x normally open, 1x normally closed, reset method: mechanical spring	8031542	VUVG-B18-T32H-MZT-F-1R8L
	5/2-way valve, single solenoid			
	External pilot air supply	Reset method: pneumatic/mechanical spring	8031543	VUVG-B18-M52-RZT-F-1R8L
		Reset method: mechanical spring	8031544	VUVG-B18-M52-MZT-F-1R8L
	5/2-way valve, double solenoid			
	External pilot air supply		8031545	VUVG-B18-B52-ZT-F-1R8L
	5/3-way valve			
	External pilot air supply	Mid-position closed	8031546	VUVG-B18-P53C-ZT-F-1R8L
		Mid-position exhausted	8031547	VUVG-B18-P53E-ZT-F-1R8L
		Mid-position pressurised	8031548	VUVG-B18-P53U-ZT-F-1R8L

Solenoid valves VUVG-B18, sub-base valves

FESTO

Ordering data

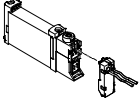
Ordering data				
	Description		Part No.	Type
Sub-base valve G ¹ / ₄ , with E-box H2				
	2x3/2-way valve			
	External pilot air supply	Normally closed, reset method: pneumatic spring	578827	VUVG-B18-T32C-AZT-F-1H2L-W1
	5/2-way valve, single solenoid			
	External pilot air supply	Reset method: mechanical spring	578828	VUVG-B18-M52-MZT-F-1H2L-W1
	5/2-way valve, double solenoid			
	External pilot air supply		578829	VUVG-B18-B52-ZT-F-1H2L-W1
	5/3-way valve			
External pilot air supply	Mid-position closed	578830	VUVG-B18-P53C-ZT-F-1H2L-W1	

Solenoid valves VUVG-B18, sub-base valves

Manifold assembly



Sub-base valve for manifold assembly
G $\frac{1}{4}$ connection

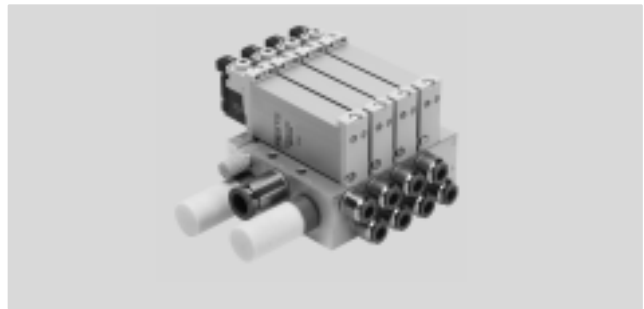

Dimensions

Download CAD data → www.festo.com

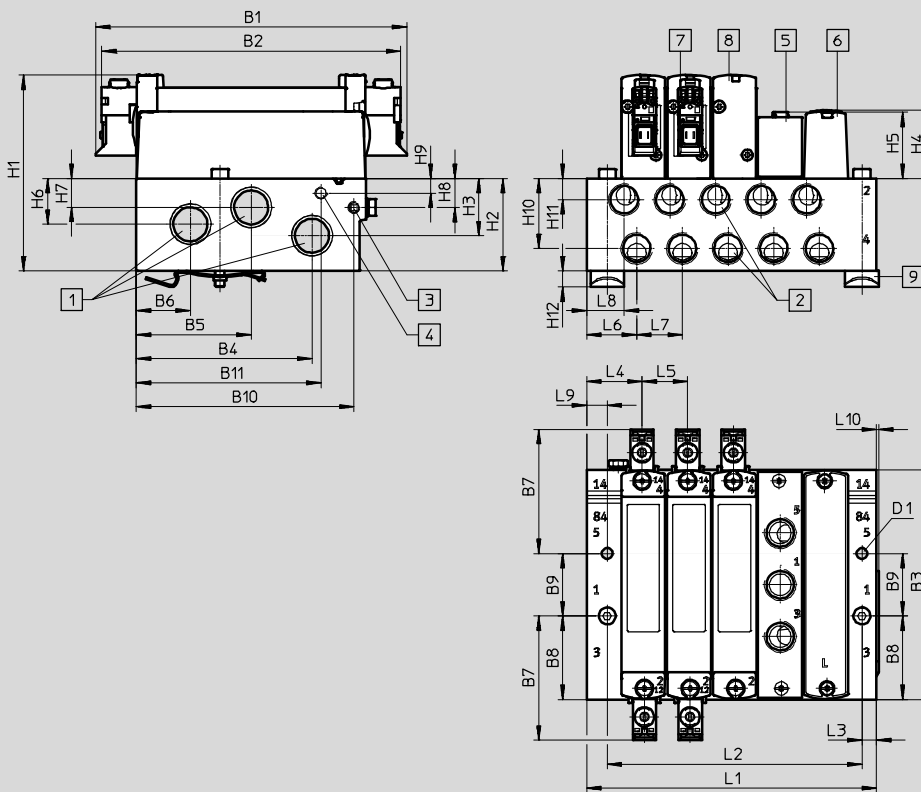

Note
More dimensions
E-boxes
→ page 103

- | | | | |
|----------------------------------------------------|---------------------------------------------------|------------------|--------------------------------------------------------------|
| 1 Ports 1, 3 and 5: G $\frac{3}{8}$ (at both ends) | 4 Port 82/84 for external pilot air: M5 | 6 Blanking plate | 9 H-rail mounting (two M4x40 screws to DIN 912 are required) |
| 2 Ports 2 and 4: G $\frac{1}{4}$ | 5 Supply plate, ports 1, 3 and 5: G $\frac{1}{4}$ | 7 Solenoid valve | |
| 3 Port 12/14 for external pilot air: M5 | | 8 Solenoid valve | |

Type	B1	B2	B3	B4	B5	B6	B7	B8	B9	B10	B11	D1
VUVG-B18 -...-F- ...	129.4	124.41	95.6	73.1	47.8	22.5	51.7	34.8	26	90.6	76.8	4.5

Type	H1	H2	H3	H4	H5	H6	H7	H8	H9	H10	H11	H12
VUVG-B18 -...-F- ...	81.6	38.5	11.5	28.4	27.6	19	12	12.1	6.1	29.1	8.8	6.5

Type	L3	L4	L5	L6	L7	L8	L9	L10
VUVG-B18 -...-F- ...	6	23	19	20.8	19	15.6	8.5	1

Solenoid valves VUVG-B18, sub-base valves

Ordering data

Valve positions	2	3	4	5	6	7	8	9	10	12	14	16
L1 [mm]	63.5	82.5	101.5	120.5	139.5	158.5	177.5	196.5	215.5	253.5	291.5	329.5
L2 [mm]	49	68	87	106	125	144	163	182	201	239	277	315
VABM weight [g]	232	306	380	454	528	602	676	750	824	972	1120	1268

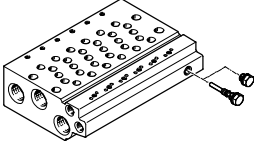
Technical data – Manifold rails ¹⁾									
	Port			CRC	Material ³⁾	Operating pressure [bar]	Max. tightening torque for assembly [Nm]		
	2, 4	1, 3, 5	12/14, 82/84				Valve	H-rail	Wall
	G ¹ / ₄	G ³ / ₈	M5	2 ²⁾	Wrought aluminium alloy	-0.9 ... 10	1.18	1.5	3

- 1) Blanking plugs are included with the manifold rail.
- 2) Corrosion resistance class 2 according to Festo standard 940 070
Components subject to moderate corrosion stress. Externally visible parts with primarily decorative surface requirements which are in direct contact with a normal industrial environment or media such as coolants or lubricating agents.
- 3) Note on materials: RoHS-compliant.

Order code – Manifold rails

VABM	-	L1	-	18	W	-	G38	-	
Valve manifold parts									Number of valve positions
Manifold rail		VABM							2 to 10, 12, 14 and 16
Valve series									Port 1, 3, 5
VUVG		L1					G38		Thread G ³ / ₈
Valve width									
18 mm					18				
Manifold rail with port 1, 2, 3, 4, 5, 12/14, 82/84									
Port 2 and 4 with G ¹ / ₄ thread									
									W



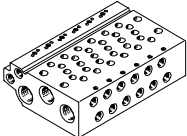

Ordering data – Manifold rails

Description	Part No.	Type	
Manifold rail for sub-base valve G ¹ / ₄			
	For valve size B18 (G ¹ / ₄)		
	2 valve positions	574467	VABM-L1-18W-G38-2
	3 valve positions	574468	VABM-L1-18W-G38-3
	4 valve positions	574469	VABM-L1-18W-G38-4
	5 valve positions	574470	VABM-L1-18W-G38-5
	6 valve positions	574471	VABM-L1-18W-G38-6
	7 valve positions	574472	VABM-L1-18W-G38-7
	8 valve positions	574473	VABM-L1-18W-G38-8
	9 valve positions	574474	VABM-L1-18W-G38-9
	10 valve positions	574475	VABM-L1-18W-G38-10
	12 valve positions	574476	VABM-L1-18W-G38-12
	14 valve positions	574477	VABM-L1-18W-G38-14
16 valve positions	574478	VABM-L1-18W-G38-16	

Solenoid valves VUVG-B18, sub-base valves

FESTO

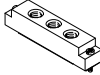
Ordering data

Ordering data – Accessories			
	Description	Part No.	Type
Blanking plate Technical data → Internet: vabb			
	For manifold rail 18W, sub-base valves	Incl. screws and seal 574482	VABB-L1-18
Separator Technical data → Internet: vabd			
	For manifold rail 18W, sub-base valves	Separator for pressure zones 574483	VABD-14-B
Supply plate Technical data → Internet: vabf			
	For manifold rail 18W	Incl. screws and seal 574481	VABF-L1-18-P3A4-G14
Seals Technical data → Internet: vabd			
	For sub-base valves B18	Delivery unit: 10 sets (each with 2 screws and 1 seal) 574480	VABD-L1-18B-S-G14

 Note

Connect supply plate at port 1 with compressed air. Reverse operation (pressure at port 3, 5) is not permissible.

Solenoid valves VUVG

E-boxes



General technical data							
Variants	H2	H3	S2	K3	L-	R1	R8
Mounting position	Any						
Electrical connection	2-pin, socket				Flying leads	Individual plug connector M8, 4-pin	Individual plug connector M8, 3-pin
Degree of protection	IP40					IP65	
Switching position display	LED						
Type of mounting	Clip					Self-tapping screw	
Note on materials	RoHS compliant						
Housing colour	Black						
Information on housing materials	PA						
Approval	RCM mark						

Protective circuit without holding current reduction

The solenoid coils (P type) of the 5, 12 and 24 V designs are equipped with a protective circuit to arrest sparks and protect against polarity reversal.

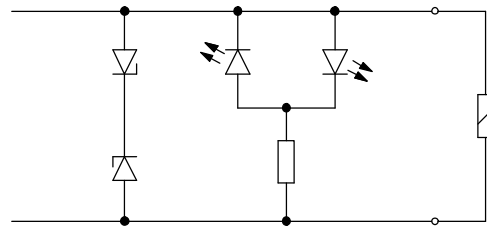

Protective circuit with holding current reduction

The 24 V DC design (R type) additionally features holding current reduction. This reduces the power from 1 W to 0.35 W.

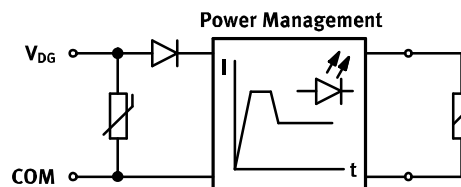



Pin allocation for E-box		
	Pin	Description
Rectangular plug connector, connection pattern H		
	VAVE-L1-1VH2-LP, VAVE-L1-1VH3-LP	
	1	+ or -
	2	+ or -
	VAVE-L1-1H2-LR, VAVE-L1-1H3-LR	
	1	+
	2	-
Rectangular plug connector, connection pattern S		
	VAVE-L1-1VS2-LP, VAVE-L1-1VS3-LP	
	1	+ or -
	2	+ or -
	VAVE-L1-1S2-LR, VAVE-L1-1S3-LR	
	1	-
	2	+
Flying leads, 2-pin		
	VAVE-L1-1VL1...4-LP	
	1	+ or -
	2	+ or -
	VAVE-L1-1L1...4-LR	
	1	-
	2	+

Solenoid valves VUVG

E-boxes

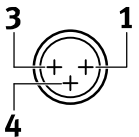
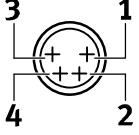
FESTO

Pin allocation for E-box			
	Pin	Description	
Round plug connector, M8, 3-pin			
	VAVE-L1-1VR8-LP		
	1	Not used	Without holding current reduction
	3	+ or -	
	4	+ or -	
	VAVE-L1-1R8-LR		With holding current reduction
	1	Not used	
3	+ or -		
4	+ or -		
Round plug connector, M8, 4-pin			
	VAVE-L1-1VR1-LP		
	1	Not used	Without holding current reduction
	2	Not used	
	3	+ or -	
	4	+ or -	
	VAVE-L1-1R1-LR		With holding current reduction
	1	Not used	
	2	Not used	
3	+ or -		
4	+ or -		
Open cable end			
	VAVE-L1-1VK...		
	BK	+ or -	Without holding current reduction
	BK	+ or -	
	VAVE-L1-1K...		With holding current reduction
	BK	+ or -	
	BK	+ or -	

Solenoid valves VUVG

E-boxes

FESTO

Dimensions

Download CAD data → www.festo.com

E-boxes, S2/H2

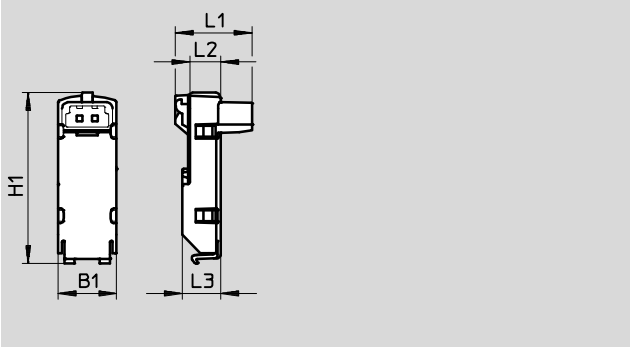

Type	B1	H1 ±0.5	L1	L2	L3
VAVE-L1-1VS2-LP	9.8	28.8	12.9	5.2	6.5
VAVE-L1-1S2-LR			10.8		
VAVE-L1-1VH2-LP					
VAVE-L1-H2-LR					

E-boxes, S3/H3

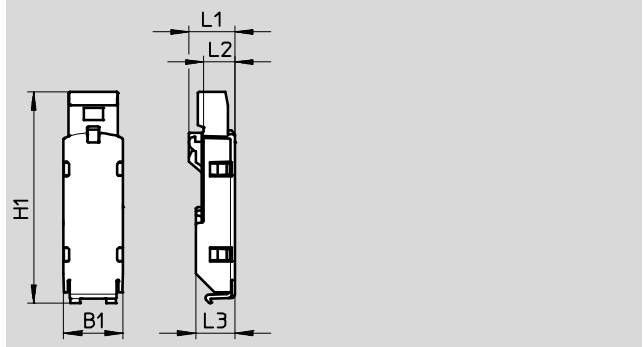

Type	B1	H1 ±0.5	L1	L2	L3
VAVE-L1-1VS3-LP	9.8	35	7.6	5.2	6.5
VAVE-L1-1S3-LR					
VAVE-L1-1VH3-LP		33.6	7.5		
VAVE-L1-1H3-LR					

Dimensions

Download CAD data → www.festo.com

E-boxes, VL11 ...1 4

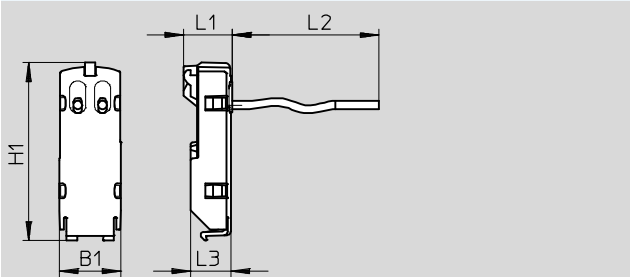

Type	B1	H1 ±0.5	L1	L2	L3
VAVE-L1-1VL1-LP	9.8	28.8	7.9	0.5	6.5
VAVE-L1-1L1-LR				1	
VAVE-L1-1VL2-LP					
VAVE-L1-1L2-LR				2.5	
VAVE-L1-1VL3-LP					
VAVE-L1-1L3-LR				5	
VAVE-L1-1VL4-LP					
VAVE-L1-1L4-LR					

E-boxes, VK6 ... 9

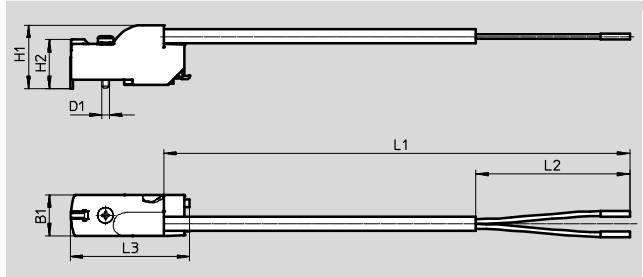

Type	B1	H1	H2 ±0.3	L1	L2 ±5	L3 ±0.5	D1 ∅
VAVE-L1-1VK6-LP	9.8	15.3	11.8	0.5	50	28.7	1.8
VAVE-L1-1VK7-LP				1.0			
VAVE-L1-1VK8-LP				2.5			
VAVE-L1-1VK9-LP				5.0			
VAVE-L1-1K6-LR				0.5			
VAVE-L1-1K7-LR				1.0			
VAVE-L1-1K8-LR				2.5			
VAVE-L1-1K9-LR				5.0			

Solenoid valves VUVG

E-boxes

FESTO

Dimensions

Download CAD data → www.festo.com

E-boxes, R8/R1

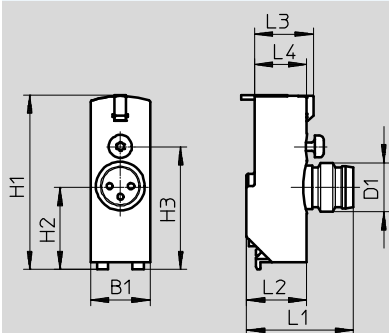



Type	B1	H1	H2	H3	L1	L2	L3	L4	D1 Ø
VAVE-L1-1VR8-LP	9.8	28.7	13.7	20.2	18.4	9.9	9.7	8.6	M8
VAVE-L1-1VR1-LP									

Ordering data – E-boxes

Design	Plug connector	Additional functions	Ambient temperature [°C]	Code	Power	Voltage	Cable length	Part No.	Type
					[W]	[V DC]	[m]		
	NEBV-H1 ...	Spark arresting, bipolar, IP40	-5 ... +50	H2	1	12/24	-	566714	VAVE-L1-1VH2-LP
		Spark arresting, holding current reduction, IP40	-5 ... +60	H2R	0.35	24	-	566716	VAVE-L1-1H2-LR
	NEBV-H1 ...	Spark arresting, bipolar, IP40	-5 ... +50	H3	1	12/24	-	566715	VAVE-L1-1VH3-LP
		Spark arresting, holding current reduction, IP40	-5 ... +60	H3R	0.35	24	-	566717	VAVE-L1-1H3-LR
	NEBV-HS ...	Spark arresting, bipolar, IP40	-5 ... +50	S2	1	12/24	-	566718	VAVE-L1-1VS2-LP
		Spark arresting, holding current reduction, IP40	-5 ... +60	S2R	0.35	24	-	566720	VAVE-L1-1S2-LR
	NEBV-HS ...	Spark arresting, bipolar, IP40	-5 ... +50	K3	1	12/24	-	566719	VAVE-L1-1VS3-LP
		Spark arresting, holding current reduction, IP40	-5 ... +60	S3R	0.35	24	-	566721	VAVE-L1-1S3-LR
	Open cable end	Spark arresting, bipolar, IP40	-5 ... +50	L1	1	12/24	-	566722	VAVE-L1-1VL1-LP
				L2			-	566723	VAVE-L1-1VL2-LP
				L3			-	566724	VAVE-L1-1VL3-LP
				L4			-	566725	VAVE-L1-1VL4-LP
	Open cable end	Spark arresting, holding current reduction, IP40	-5 ... +60	L1R	0.35	24	-	566726	VAVE-L1-1L1-LR
				L2R			-	566727	VAVE-L1-1L2-LR
				L3R			-	566728	VAVE-L1-1L3-LR
				L4R			-	566729	VAVE-L1-1L4-LR
	Open cable end	Spark arresting, bipolar, IP65	-5 ... +60	K6	1	12/24	0.5	573941	VAVE-L1-1VK6-LP
				K7			1	573942	VAVE-L1-1VK7-LP
				K8			2.5	573943	VAVE-L1-1VK8-LP
				K9			5	573944	VAVE-L1-1VK9-LP
	Open cable end	Spark arresting, bipolar, holding current reduction, IP65	-5 ... +60	K6R	0.35	24	0.5	573945	VAVE-L1-1K6-LR
				K7R			1	573946	VAVE-L1-1K7-LR
				K8R			2.5	573947	VAVE-L1-1K8-LR
				K9R			5	573948	VAVE-L1-1K9-LR
	NEBU-M8 ...	Spark arresting, bipolar, IP65	-5 ... +60	R8	1	12/24	-	573919	VAVE-L1-1VR8-LP
		Spark arresting, bipolar, holding current reduction, IP65		R8R	0.35	24	-	573920	VAVE-L1-1R8-LR
		Spark arresting, bipolar, IP65		R1	1	12/24	-	573921	VAVE-L1-1VR1-LP
		Spark arresting, bipolar, holding current reduction, IP65		R1R	0.35	24	-	573922	VAVE-L1-1R1-LR

Solenoid valves VUVG

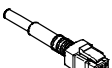
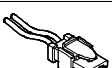
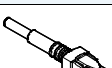
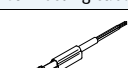





Accessories

Ordering data				
	Description	Cable length [m]	Part No.	Type
Plug socket with cable, not sheathed, open end Technical data → Internet: nebv				
	For E-box code H2, H2R or H3, H3R, 2-pin socket	0.5	566654	NEBV-H1G2-KN-0.5-N-LE2
		1	566655	NEBV-H1G2-KN-1-N-LE2
		2.5	566656	NEBV-H1G2-KN-2.5-N-LE2
		5	566657	NEBV-H1G2-KN-5-N-LE2
Plug socket with cable, sheathed, open end Technical data → Internet: nebv				
	For E-box code H2, H2R or H3, H3R, 2-pin socket	0.5	566658	NEBV-H1G2-P-0.5-N-LE2
		1	566659	NEBV-H1G2-P-1-N-LE2
		2.5	566660	NEBV-H1G2-P-2.5-N-LE2
		5	566661	NEBV-H1G2-P-5-N-LE2
Plug socket with cable, not sheathed, open end Technical data → Internet: nebv				
	For E-box code S2, S2R or S3, S3R, 2-pin socket	0.5	566662	NEBV-HSG2-KN-0.5-N-LE2
		1	566663	NEBV-HSG2-KN-1-N-LE2
		2.5	566664	NEBV-HSG2-KN-2.5-N-LE2
		5	566665	NEBV-HSG2-KN-5-N-LE2
Plug socket with cable, sheathed, open end Technical data → Internet: nebv				
	For E-box code S2, S2R or S3, S3R, 2-pin socket	0.5	566666	NEBV-HSG2-P-0.5-N-LE2
		1	566667	NEBV-HSG2-P-1-N-LE2
		2.5	566668	NEBV-HSG2-P-2.5-N-LE2
		5	566669	NEBV-HSG2-P-5-LE2
Connecting cable, open end Technical data → Internet: nebu				
	For E-box code R8 3-pin, straight socket, M8x1	2.5	541333	NEBU-M8G3-K-2.5-LE3
		5	541334	NEBU-M8G3-K-5-LE3
	For E-box code R1 4-pin, straight socket, M8x1	2.5	541342	NEBU-M8G4-K-2.5-LE4
		5	541343	NEBU-M8G4-K-5-LE4
Connecting cable, open end Technical data → Internet: nebu				
	For E-box code R8 3-pin, angled socket, M8x1	2.5	541338	NEBU-M8W3-K-2.5-LE3
		5	541341	NEBU-M8W3-K-5-LE3
	For E-box code R1 4-pin, angled socket, M8x1	2.5	541344	NEBU-M8W4-K-2.5-LE4
		5	541345	NEBU-M8W4-K-5-LE4
Connecting cable Technical data → Internet: nebu				
	For E-box code R8 3-pin, straight socket, M8x1	0.5	541346	NEBU-M8G3-K-0.5-M8G3
		1	541347	NEBU-M8G3-K-1-M8G3
		2.5	541348	NEBU-M8G3-K-2.5-M8G3
		5	541349	NEBU-M8G3-K-5-M8G3
		10	569844	NEBU-M8G3-K-10-M8G3
	For E-box code R1 4-pin, straight socket, M8x1	2.5	554035	NEBU-M8G4-K-2.5-M8G4

Solenoid valves VUVG

Accessories







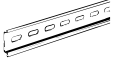

FESTO

Ordering data						
Description			Part No.	Type	PU ¹⁾	
Blanking plug Technical data → Internet: b						
	For manifold rail and valve	M5 thread	3843	B-M5	10	
		M7 thread	174309	B-M7	10	
	For manifold rail	G $\frac{1}{8}$ thread	3568	B-$\frac{1}{8}$	10	
		G $\frac{1}{4}$ thread	3569	B-$\frac{1}{4}$	10	
		G $\frac{3}{8}$ thread	3570	B-$\frac{3}{8}$	10	
	For valve	For valve size 14 (G $\frac{1}{8}$)	578406	NPQH-BK-G18-P10	10	
		For valve size 18 (G $\frac{1}{4}$)	578407	NPQH-BK-G14-P10	10	
Reducing nipple						
	Male thread M7	Female thread M5	161359	D-M5I-M7A-ISK	10	
Fittings Technical data → Internet: qsm						
	M3 thread	For tubing \varnothing 3 mm	Round releasing ring	133001	QSM-M3-3-I-R	10
		For tubing \varnothing 4 mm	Round releasing ring	133002	QSM-M3-4-I-R	10
	M5 thread	For tubing \varnothing 3 mm	Round releasing ring	133003	QSM-M5-3-I-R	10
			Oval releasing ring	153313	QSM-M5-3-I	10
		For tubing \varnothing 4 mm	Round releasing ring	133004	QSM-M5-4-I-R	10
			Oval releasing ring	153315	QSM-M5-4-I	10
		For tubing \varnothing 6 mm	Round releasing ring	133005	QSM-M5-6-I-R	10
			Oval releasing ring	153317	QSM-M5-6-I	10
	M7 thread	For tubing \varnothing 4 mm	Oval releasing ring	153319	QSM-M7-4-I	10
		For tubing \varnothing 6 mm	Round releasing ring	133007	QSM-M7-6-I-R	10
			Oval releasing ring	153321	QSM-M7-6-I	10
	G $\frac{1}{8}$ thread	For tubing \varnothing 4 mm	Oval releasing ring	186106	QS-G1/8-4-I	10
		For tubing \varnothing 6 mm	Oval releasing ring	186107	QS-G1/8-6-I	10
		For tubing \varnothing 8 mm	Oval releasing ring	186109	QS-G1/8-8-I	10
		For tubing \varnothing 10 mm	Oval releasing ring	132999	QS-G1/8-10-I	10
	G $\frac{1}{4}$ thread	For tubing \varnothing 6 mm	Oval releasing ring	186108	QS-G1/4-6-I	10
				130918	QS-B-1/4-6-20	20
		For tubing \varnothing 8 mm	Oval releasing ring	186110	QS-G1/4-8-I	10
				130995	QS-B-1/4-8-I-20	20
		For tubing \varnothing 10 mm	Oval releasing ring	186112	QS-G1/4-10-I	10
			132152	QS-B-1/4-10-I-20	20	
	G $\frac{3}{8}$ thread	For tubing \varnothing 8 mm	Oval releasing ring	130921	QS-B-3/8-8-10	10
		For tubing \varnothing 10 mm	Oval releasing ring	130922	QS-B-3/8-10-10	10
		For tubing \varnothing 12 mm	Oval releasing ring	132123	QS-B-3/8-12-10	10
For tubing \varnothing 16 mm		Oval releasing ring	132124	QS-B-3/8-16-10	10	
Silencer Technical data → Internet: amte						
	For M3 thread		1231120	AMTE-M-LH-M3	20	
	For M5 thread		1205858	AMTE-M-LH-M5	20	
	For M7 thread		161418	UC-M7	1	
	For G $\frac{1}{8}$ thread	High flow rate	2307	U-1/8	1	
		Lower flow rate	161419	UC-1/8	1	
	For G $\frac{1}{4}$ thread	High flow rate	2316	U-1/4	1	
		Lower flow rate	165004	UC-1/4	1	
	For G $\frac{3}{8}$ thread	High flow rate	2309	U-3/8	1	
		Lower flow rate	1707427	UC-3/8	1	
		Metal housing	6843	U-3/8-B	1	

1) Packaging unit.

Solenoid valves VUVG

Accessories

Ordering data						
Description		Part No.	Type	PU ¹⁾		
H-rail Technical data → Internet: nrh						
	To EN 60715, 35 x 7.5 (WxH)	Length: 2 m	35430	NRH-35-2000	1	
H-rail mounting Technical data → Internet: vame						
	-		569998	VAME-T-M4	2	
Cover cap for manual override						
	Covered		540898	VMPA-HBV-B	10	
	Non-detenting		540897	VMPA-HBT-B	10	
	Detenting (without accessories)		8002234	VAMC-L1-CD	10	
Inscription label holder Technical data → Internet: aslr						
	Holder for an inscription label and covering the mounting screw and manual override		570818	ASLR-D-L1	10	
Flow control						
	For M5 valves, for setting the flow rate during pressurisation and exhausting b value: 0.5	Flow rate: 9.6 l/min	C value: 0.04	8025709	VFFG-T-M5-5	10
		Flow rate: 14.6 l/min	C value: 0.05	8025710	VFFG-T-M5-6	10
		Flow rate: 19.1 l/min	C value: 0.07	8025711	VFFG-T-M5-7	10
		Flow rate: 26.1 l/min	C value: 0.10	8025712	VFFG-T-M5-8	10
		Flow rate: 40.8 l/min	C value: 0.14	8025713	VFFG-T-M5-10	10
		Flow rate: 45.4 l/min	C value: 0.16	8025714	VFFG-T-M5-12	10
		Flow rate: 67.4 l/min	C value: 0.25	8025715	VFFG-T-M5-15	10
Restrictor set						
	Two of each size		8025716	VFFG-T-M5-A-V1	14	

1) Packaging unit.

Valve terminals VTUG with multi-pin plug and fieldbus connection

FESTO

Key features

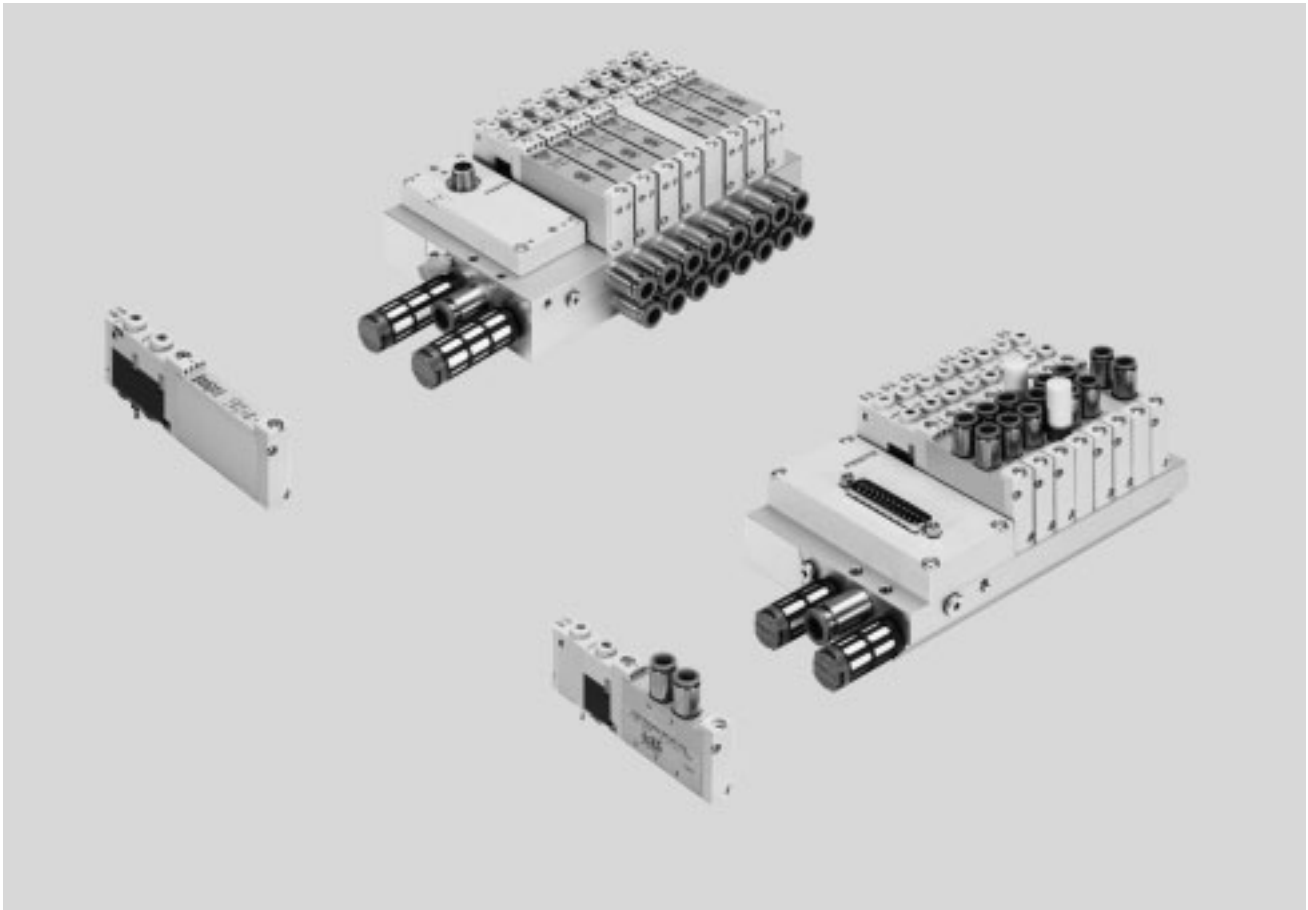

Innovative

- Festo-specific I-Port interface for bus nodes (CTEU)
- IO-Link mode for direct connection to a higher-level IO-Link master
- Festo-specific I-Port interface with interlock
- Variable multi-pin plug connection using Sub-D or flat cable
- Reversible piston spool valves, up to 24 valve positions
- Reduced power consumption
- Excellent price/performance ratio

Versatile

- Choice of quick plug connectors
- Multiple pressure zones possible
- Sub-D variant and fieldbus connection rated to IP67
- Internal or external pilot air with the same manifold rail possible through the use of blanking plugs
- Sub-base valves with working ports underneath for installation in control cabinets

Reliable

- Sturdy and durable metal components
 - Valves
 - Manifold rails
- Fast troubleshooting thanks to LED display
- Manual override: choose from non-detenting, detenting or covered

Easy to mount

- Easy mounting thanks to captive screws and seal
- Connection technology easy to change
- Inscription label holder for labelling

Valve terminal configurator

A valve terminal configurator is available to help you select a suitable valve terminal VTUG. This makes it much easier to order the right product.

Valve terminals VTUG are ordered via an ident. code. All valve terminals are supplied fully assembled and individually tested.

This reduces assembly and installation time to a minimum.

Download CAD data → www.festo.com

Ordering system for valve terminal VTUG
→ Internet: vtug

Valve terminals VTUG with multi-pin plug and fieldbus connection

Key features

Sub-base and semi in-line valves

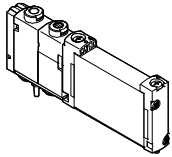

VUVG-B...1T1
Sub-base valve

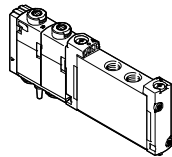

VUVG-S...1T1
Semi in-line valve

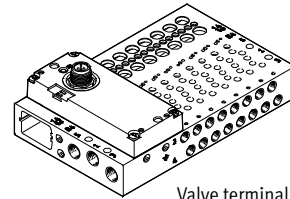

Valve terminal VTUG with variable electrical connection

Overview – Valve terminal with multi-pin plug and fieldbus connection

Variable electrical connection:
flat cable or Sub-D

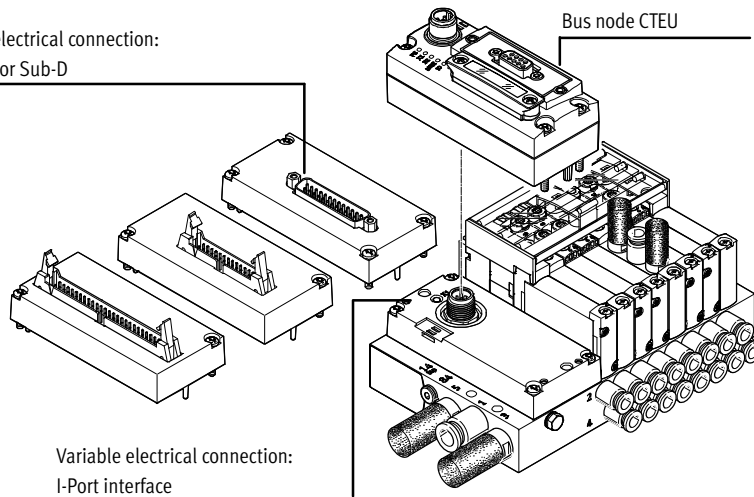

Variable electrical connection:
I-Port interface

Overview – Valve terminal with interlock

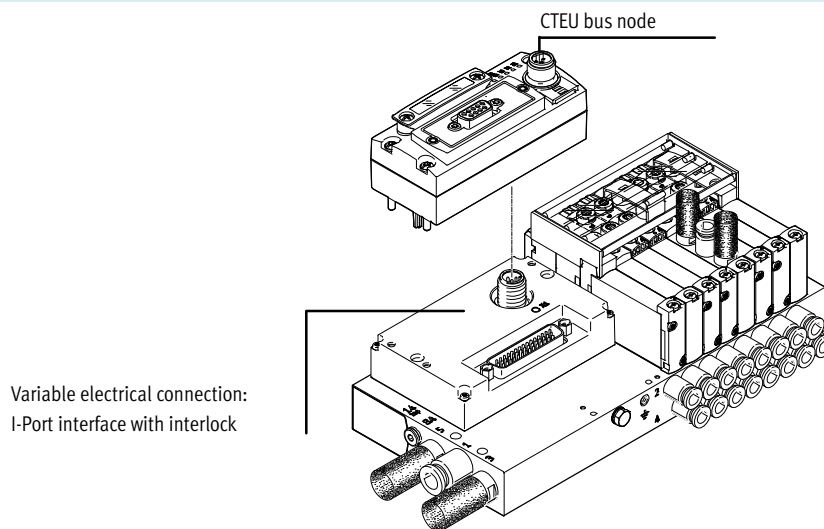

Variable electrical connection:
I-Port interface with interlock

Valve terminals VTUG with multi-pin plug and fieldbus connection

Key features

FESTO

Equipment options

Valve functions

- 2x3/2-way, 3/2-way, 5/2-way, 5/3-way valves
- Reversible piston spool valves, up to 24 valve positions

Electrical connection options

- IO-Link mode for direct connection to a higher-level IO-Link master
- Festo-specific I-Port interface for bus nodes (CTEU)
- Variable multi-pin plug connection using Sub-D or flat cable
- Festo-specific I-Port interface with interlock (for valves of width 10 mm)

Basic valves VUUG

Width

- 10 mm
- 14 mm
- 18 mm

Variants

- Semi in-line valve
- Sub-base valve

Valve functions

3/2-way valve

- Single solenoid
- Normally open
- Normally closed

2x3/2-way valve

- Single solenoid
- Normally open
- Normally closed
- 1x normally closed, 1x normally open
- Mechanical spring
- Pneumatic spring

5/2-way valve

- Single solenoid
- Pneumatic/mechanical spring
- Mechanical spring
- Pneumatic spring
- Double solenoid valve

5/3-way valve

- Mid-position pressurised
- Mid-position exhausted
- Mid-position closed

Cover caps for manual override

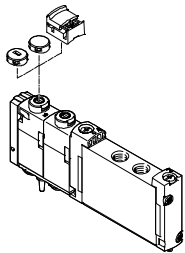

- Closed cover cap, covered manual override
- Slotted cover cap, non-detenting manual override
- Cover cap for detenting actuation without tools

Inscription label holder

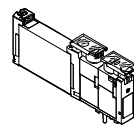

Inscription label holder ASLR-D-L1 for identifying the valves and as a cover for the manual override.

Inscription label holder

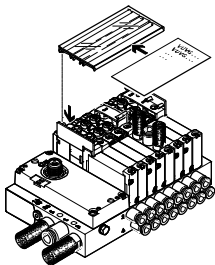

Inscription label holder ASCF-H-L1... for identifying the valves on the valve terminal VTUG.

Valve terminals VTUG with multi-pin plug and fieldbus connection

Key features

Electrical connection

Multi-pin plug connection

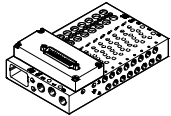

The signals are transmitted from the controller to the valve terminal via a pre-assembled or self-assembled multi-wire cable to the multi-pin plug connection,

which substantially reduces installation time compared to individually connected valves. The valve terminal can be equipped with max. 48 solenoid coils.

Versions:

- Sub-D connection
- Flat cable

I-Port interface

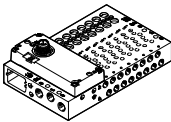

Festo-specific interface as a basis for bus nodes (CTEU) or in IO-Link mode for direct connection to a higher-level IO-Link master.

Communication and power supply take place via a common M12 interface.

Connection options:

- As I-Port interface for bus nodes (CTEU)
- In IO-Link mode for direct connection to an IO-Link master

I-Port interface with interlock

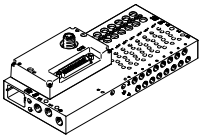

The interlock function enables the first 16 solenoid coils to be individually supplied externally.

The external supply guarantees safety-related release of these valves.



- Note

The VTUG variant with multi-pin plug and fieldbus connection offers the additional option of individual

electrical actuation of the valves (see → page 129).

Valve terminals VTUG with multi-pin plug and fieldbus connection

Key features – Pneumatic components

Manifold rail

For semi in-line valves

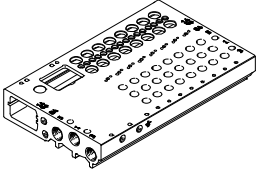

The semi in-line valves are supplied with external pilot air. The pilot air is set via the manifold rail. The manifold rail is delivered with a short and a long blanking plug for setting the pilot air.

- For semi in-line valves M5/M7 (width 10 mm), G1/8 (width 14 mm) and G1/4 (width 18 mm)
- For 2x3/2-way, 5/2-way and 5/3-way valves
- 4 to 24 valve positions with electrical interlinking

For sub-base valves

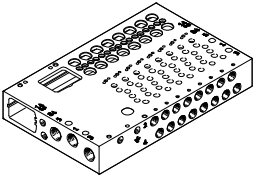

The sub-base valves are supplied with external pilot air. The pilot air is set via the manifold rail. The manifold rail is delivered with a short and a long blanking plug for setting the pilot air.

- For sub-base valves M5/M7 (width 10 mm), G1/8 (width 14 mm) and G1/4 (width 18 mm)
- For 2x3/2-way, 3/2-way, 5/2-way and 5/3-way valves
- 4 to 24 valve positions with electrical interlinking

Long version

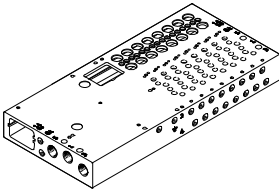

Versions:

- I-Port interface with lateral outlet direction: for semi in-line valves and sub-base valves M5/M7 (width 10 mm), G1/8 (width 14 mm) and G1/4 (width 18 mm)
- Interlock: For sub-base and semi in-line valves M5/M7 (width 10 mm)

For control cabinet installation, outlet underneath

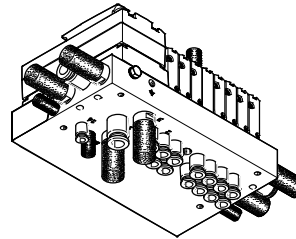

For sub-base valves M5/M7 (width 10 mm)

Note
Pressurisation and exhaust at both ends is recommended for an optimised flow rate in cases where multiple valves switch simultaneously.

Supply plate

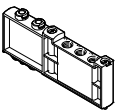

For additional air supply and exhaust via a valve position

Note
The supply plate VABF-L1-14-P3A4-G18-T1 can only

be used with G fittings. R fittings are not permissible.

Blanking plate for unused valve position

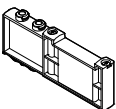

Vacant position cover

Separator for pressure zones



For creating multiple pressure zones in a valve terminal

Valve terminals VTUG with multi-pin plug and fieldbus connection

Key features – Pneumatic components

Creating pressure zones and separating exhaust air

Compressed air is supplied and exhausted via the manifold rail and via supply plates.

The position of the supply plates and duct separations can be freely selected with the VTUG.

A pressure zone is created by separating the internal supply ducts using a separator.

Pressure zone separation can be used for the following ducts:

- Duct 1
- Duct 3
- Duct 5

 Note

- Use a separator if the exhaust air pressures are high
- Use at least one supply plate/ supply for each pressure zone
- Pressure zone separation is not possible in duct 12/14 (pilot air supply)

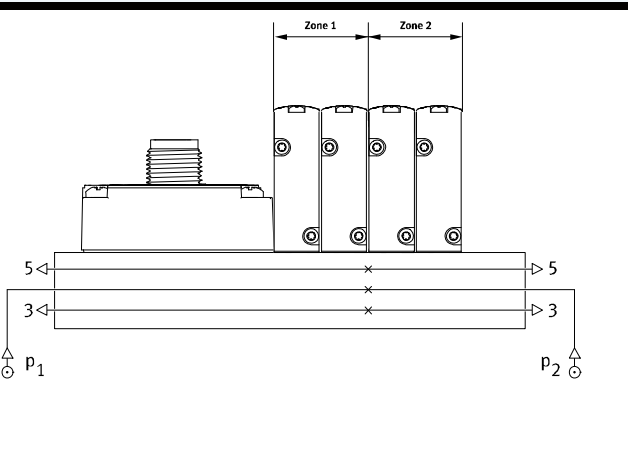
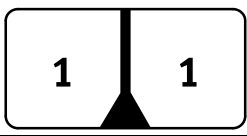
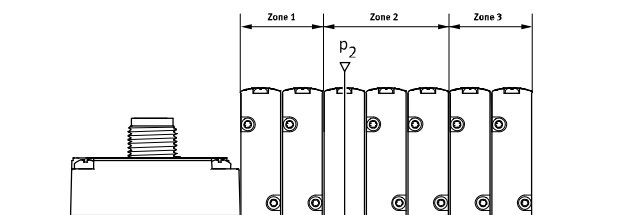
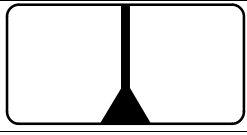
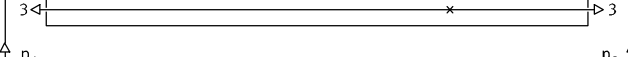
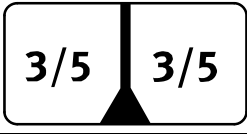
Duct separation	Description
	<p>The pressure zones can be freely configured with the VTUG. The following duct separations are possible:</p> <p>Duct 1 closed</p> 
	<p>Duct 1, 3, 5 closed</p> 
	<p>Duct 3, 5 closed</p> 
	<p>The number of pressure zones with the VTUG is limited by the number of valve positions on the manifold rail. Note that each supply plate occupies one valve position.</p>

Separator VABD

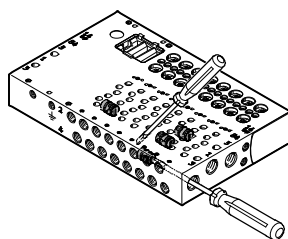

1 Separator VABD

 Note

With the VTUG, several pressure zones can be created by fitting separators (VABD). The separators are inserted in the manifold rail using a slotted screwdriver.

Valve terminals VTUG with multi-pin plug and fieldbus connection

Key features – Pneumatic components



Pilot air supply		
Internal pilot air supply	External pilot air supply	Pilot exhaust air
Internal pilot air supply can be chosen with an operating pressure in the range 1.5 ... 8 bar, 2.5 ... 8 bar or 3 ... 8 bar (depending on the valve used).	The pilot air supply is branched from duct 1 (compressed air supply) using an internal connection.	External pilot air supply is required for vacuum operation and operating pressures above 8 bar. The port for external pilot air supply (port 12/14) is located on the manifold rail.
		The pilot air is exhausted via duct 82/84 of the manifold rail.

Pilot air supply

- 1 Blanking plug, short, with internal pilot air
- 2 Blanking plug for duct 12/14 with internal pilot air
- 3 Blanking plug, long, with external pilot air
- 4 Push-in fitting in duct 12/14 with external pilot air

The manifold rails have an internal conduit between duct 12/14 and duct 1. Internal or external pilot air supply is selected by inserting a blanking plug into this conduit.

Flow control

- 1 Valve VUVG with individual electrical connection
- 2 Flow control
- 3 Fitting

Semi in-line valve, individual electrical connection: flow control can be fitted in port 1, 2, 3, 4, 5.

Sub-base valve, individual electrical connection: flow control can be fitted in port 2, 4.

Valve terminal VTUG with electrical multi-pin plug and fieldbus connection: flow control can be fitted in port 2, 4.

Valve terminals VTUG with multi-pin plug and fieldbus connection

Key features – Pneumatic components

Operation with different pressures

Vacuum operation

Points to note with 3/2-way valves with pneumatic spring return:

The 3/2-way valves are available in a design with two valves in one valve body and with pneumatic spring return. With these valves, the force for the return movement is obtained from port 1.

Vacuum operation is only possible at port 3 and 5, not at port 1.

With external pilot air supply, vacuum can be connected at port 1, 3, 5 of the 5/2-way and 5/3-way valves.

Reverse operation

The 3/2-way valves with pneumatic spring are not suitable for reverse operation, since at least the minimum pilot pressure must be present in duct 1.

 Note
Pressure must be present at port 1.

Pressure deflector (internal pilot air)

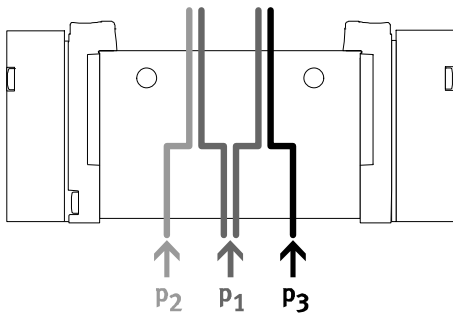

- Two different pressures required.
- Different pressures can be connected at duct 1, 3 and 5.

Benefits

Any pressure or vacuum can be connected at duct 3 and 5 both with external and internal pilot air

 Note

- With internal pilot air, adhere to the minimum pilot pressure in duct 1
- With 2x3/2-way valves without spring return, adhere to minimum pilot pressure in duct 1

Vacuum, ejector pulse and normal position

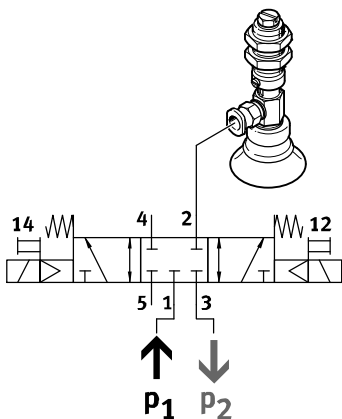

Vacuum, ejector pulse and normal position with internal pilot air can be achieved by connecting vacuum at duct 3 and pressure for the ejector pulse at duct 1.

Valve terminals VTUG with multi-pin plug and fieldbus connection

Key features – Pneumatic components

Standard nominal flow rate q_{nN} as a function of the number of switched valves n

Width 10 mm, 5/2-way valves

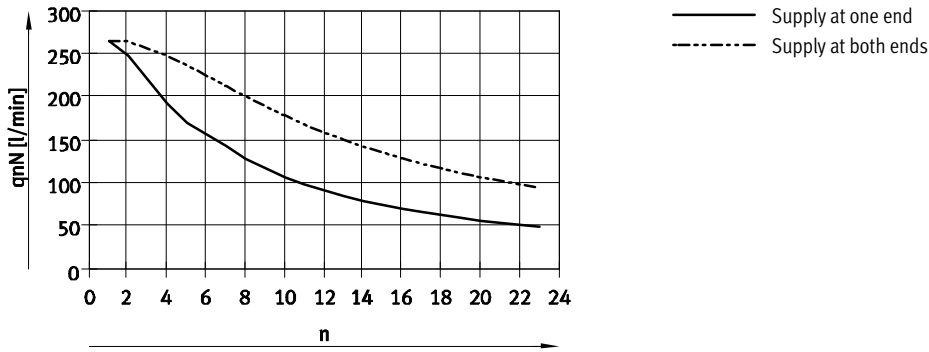

Width 14 mm

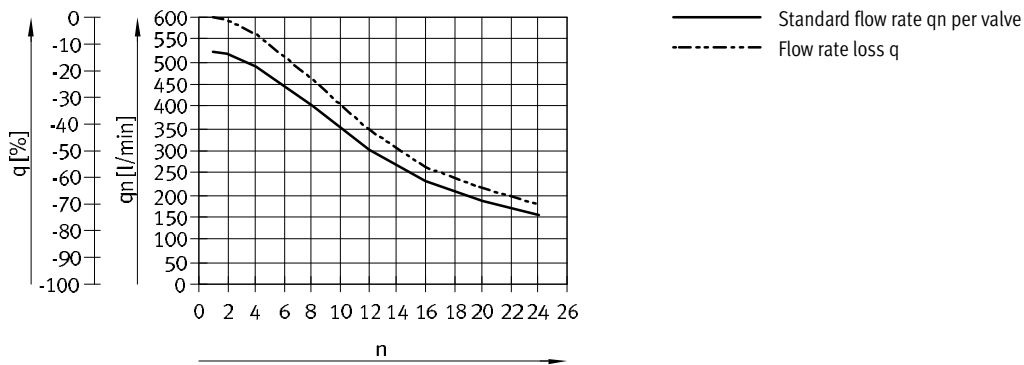

Width 18 mm

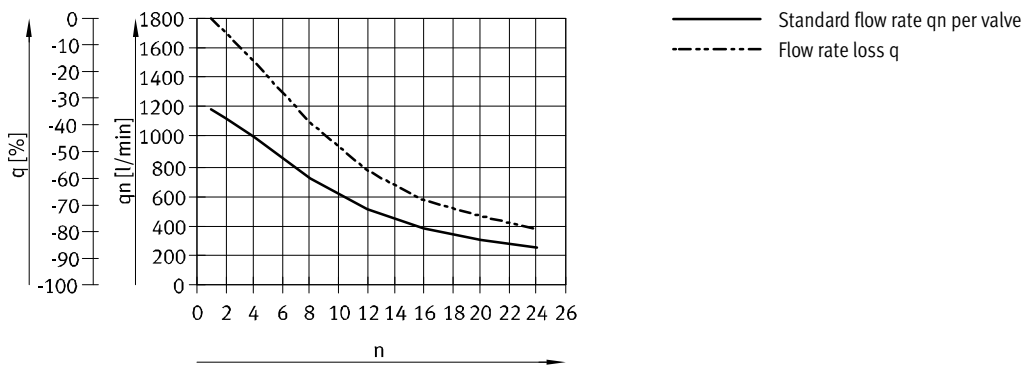

Valve terminals VTUG with multi-pin plug and fieldbus connection

Key features – Pneumatic components

Pilot pressure p2 as a function of operating pressure p1

2x3/2-way valve, reset method: mechanical spring

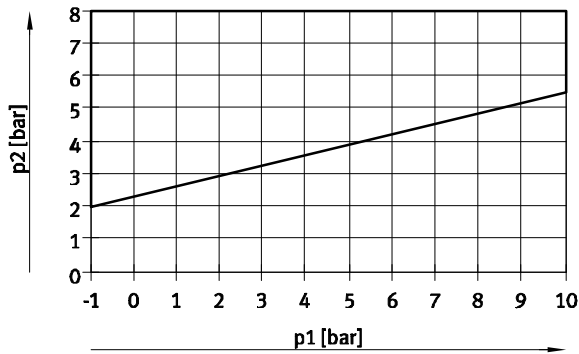

2x3/2-way valve, reset method: pneumatic spring

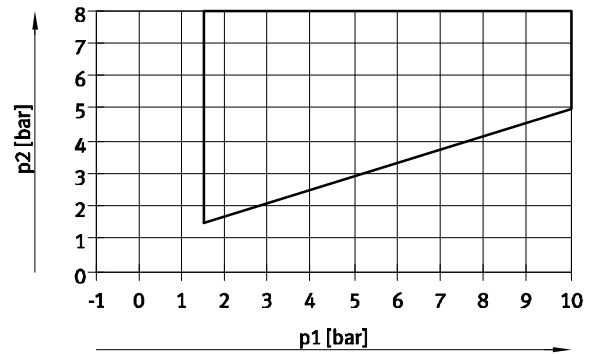

3/2-way single solenoid valve and 5/2-way single solenoid valve

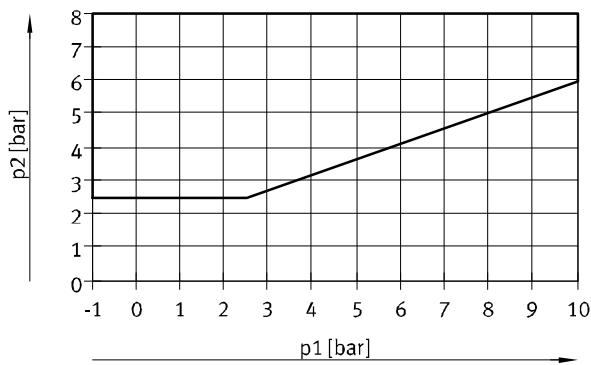

Valve terminals VTUG with multi-pin plug and fieldbus connection

Key features – Assembly

Valve terminal assembly

Sturdy terminal assembly thanks to:

- Four through-holes for wall mounting
- H-rail mounting

 Note

Use the M5 thread provided on the manifold block for earthing the valve terminal.

Wall mounting

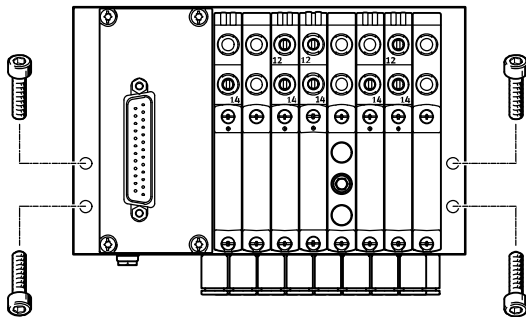

Screw the valve terminal VTUG onto the mounting surface using four M4 screws.

The mounting holes are on the left and right side of the manifold rail.

H-rail mounting

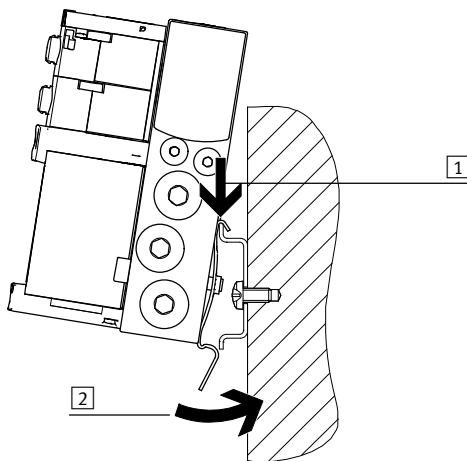

Attach the valve terminal VTUG to the H-rail (see arrow **1**).

Swivel the valve terminal onto the H-rail and secure in place with the clamping component (see arrow **2**).

Attach the manifold rails to an H-rail to EN 60715-TH35 using the H-rail mounting kit VAME-T-M4.

Use the following screws (to DIN 912) to attach the manifold rails:

- Size 10: M4x30
- Size 14: M4x40
- Size 18: M5x50

 Note

Permissible use of the H-rail:

- Manifold rail with outlet on the side or on top.
- H-rail exclusively for horizontal mounting.
- Vibration/shock loads are not permissible for this type of mounting.

Size 14:

- Use H-rail TH35-7.5 for valve terminals with a maximum of 8 valve positions.
- Use H-rail TH35-15 for mounting in accordance with the standard and for more than 8 valve positions.

Valve terminals VTUG with multi-pin plug and fieldbus connection

Key features – Assembly

Manual override (MO)

MO with automatic return (non-detenting)

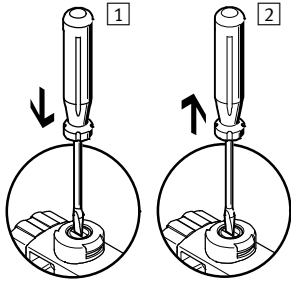

- 1 Press in the stem of the MO with a pointed object or screwdriver. Pilot valve switches and actuates the main valve.
- 2 Remove the pointed object or screwdriver. Spring force pushes the stem of the MO back. Pilot valve returns to its initial position as does the single solenoid main valve (not the case with double solenoid valve code J).

MO with detent (locking)

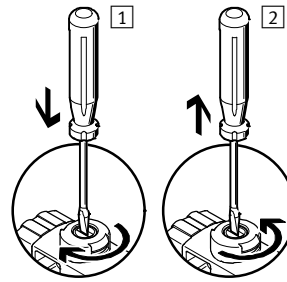

- 1 Press in the stem of the MO with a pointed object or screwdriver until the valve switches and then turn the stem clockwise by 90° until the stop is reached. Valve remains switched.
- 2 Turn the stem anti-clockwise by 90° until the stop is reached and then remove the pointed object or screwdriver. Spring force pushes the stem of the MO back. The valve returns to its initial position (not the case with double solenoid valve code J).

MO non-detenting – with coded cover cap

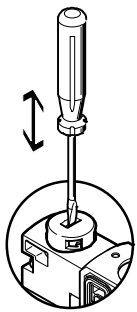

MO is actuated by pushing it with a pointed object or screwdriver and reset by spring force (detenting position prevented due to coded cover cap).

MO detenting without tools – assembly

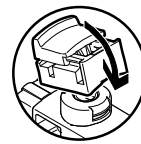

Turn MO to clip it onto the pilot valve. The MO cap can then be operated (detenting) without tools.

MO detenting without tools – actuation

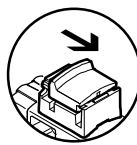

Sliding the cap for the MO in the direction of the arrow causes the following to happen:

- Cap locks into the stop position.
- Pilot valve switches and actuates the main valve.

MO detenting without tools – actuation

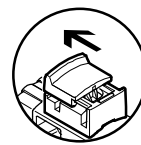

Sliding the cap for the MO in the direction of the arrow causes the following to happen:

- Cap locks into the stop position.
- Spring force pushes the stem of the MO back.
- Pilot valve returns to its initial position as does the single solenoid main valve (not the case with double solenoid valve code J).

Valve terminals VTUG with multi-pin plug and fieldbus connection

Key features – Assembly

Inscription system

Inscription label holder

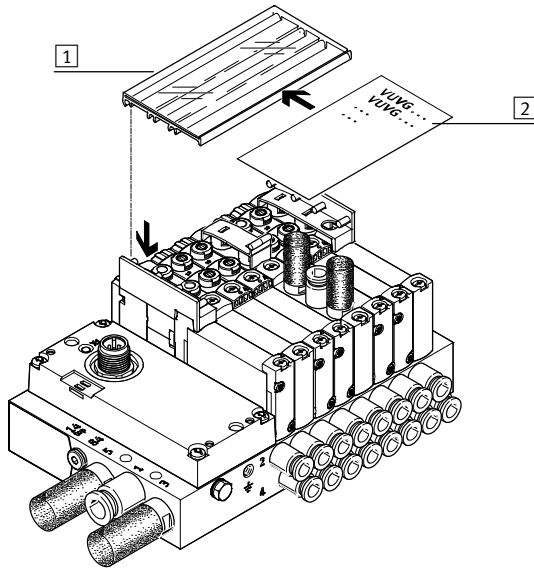

- 1 Inscription label holder
ASCF-H-L1 (code TT)
- 2 Inscription label

Mount the inscription label holder to label the valves. Open the inscription label holder to insert the inscription label and actuate the manual override. The inscription label holders are available in different sizes depending on the number of valve positions.

-  - Note

Do not engage the manual override before mounting the inscription label holder. The retainer for the inscription label holder covers the manual override of the valve beneath it when mounted. The manual override for the two valves under the inscription label holder retainers can then only be actuated in a non-detenting manner.

Inscription label holder

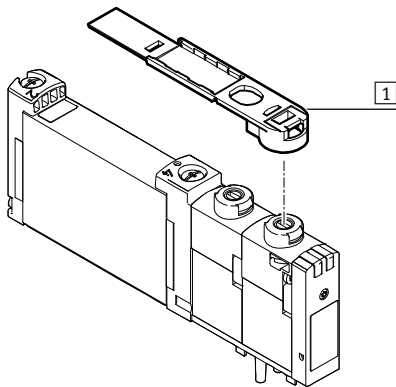

- 1 Inscription label holder
ASLR-D-L1 (code TV)

Use inscription label holder ASLR-D-L1 (code TV) to label individual valves. The inscription label holder is placed directly on the manual override.

-  - Note

Do not engage the manual override before mounting the inscription label holder. After the retainers are installed, the manual override can only be actuated in a non-detenting manner.

Valve terminals VTUG with multi-pin plug and fieldbus connection

Overview of valve functions

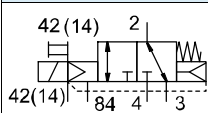
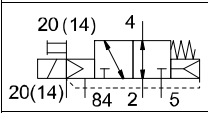
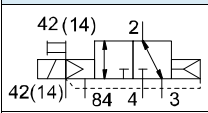
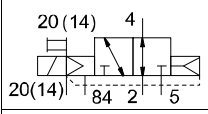
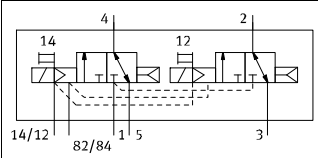
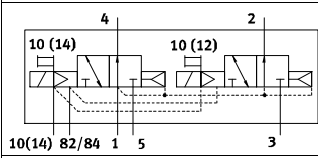
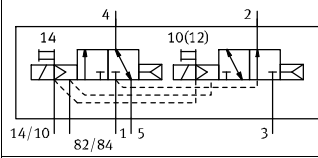
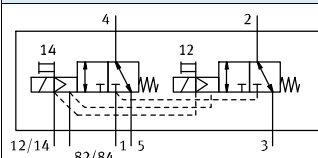
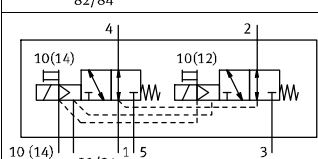
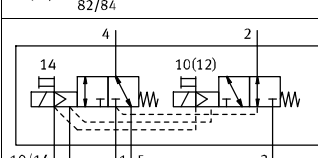
Valve	Valve code	Description	Valve terminal/ position function order code	Size		
				M5/M7	G1/8	G1/4
3/2-way valve, pneumatic/mechanical spring						
	M32C-R	Normally closed	VX	■	-	-
	M32U-R	Normally open	VW	■	-	-
3/2-way valve, pneumatic spring						
	M32C-A	Normally closed	VX	-	■	-
	M32U-A	Normally open	VW	-	■	-
2x3/2-way valve, pneumatic spring						
	T32C-A	Normally closed	C	■	■	■
	T32U-A	Normally open	N	■	■	■
	T32H-A	1x normally open, 1x normally closed	H	■	■	■
2x3/2-way valve, mechanical spring						
	T32C-M	Normally closed	VK	■	■	■
	T32U-M	Normally open	VN	■	■	■
	T32H-M	1x normally open, 1x normally closed	VH	■	■	■

Valve terminals VTUG with multi-pin plug and fieldbus connection

Overview of valve functions

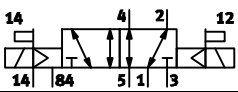
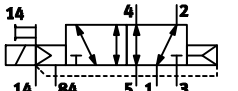
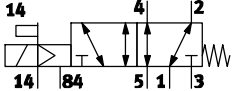
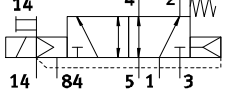
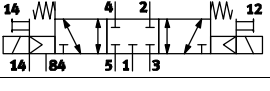
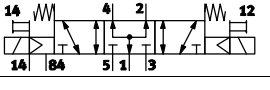
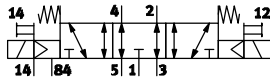
Valve	Valve code	Description	Valve terminal/ position function order code	Size		
				M5/M7	G1/8	G1/4
5/2-way valve, double solenoid						
	B52	External pilot air supply	J	■	■	■
5/2-way valve, single solenoid						
	M52-A	Pneumatic spring	M	-	■	-
	M52-M	Mechanical spring	A	■	■	■
	M52-R	Pneumatic/mechanical spring	P	■	-	■
5/3-way valve						
	P53C	Mid-position closed	G	■	■	■
	P53U	Mid-position pressurised	B	■	■	■
	P53E	Mid-position exhausted	E	■	■	■

Valve terminals VTUG with multi-pin plug and fieldbus connection

Peripherals overview example – Semi in-line valves

Valve terminal overview – Multi-pin plug and I-Port interface

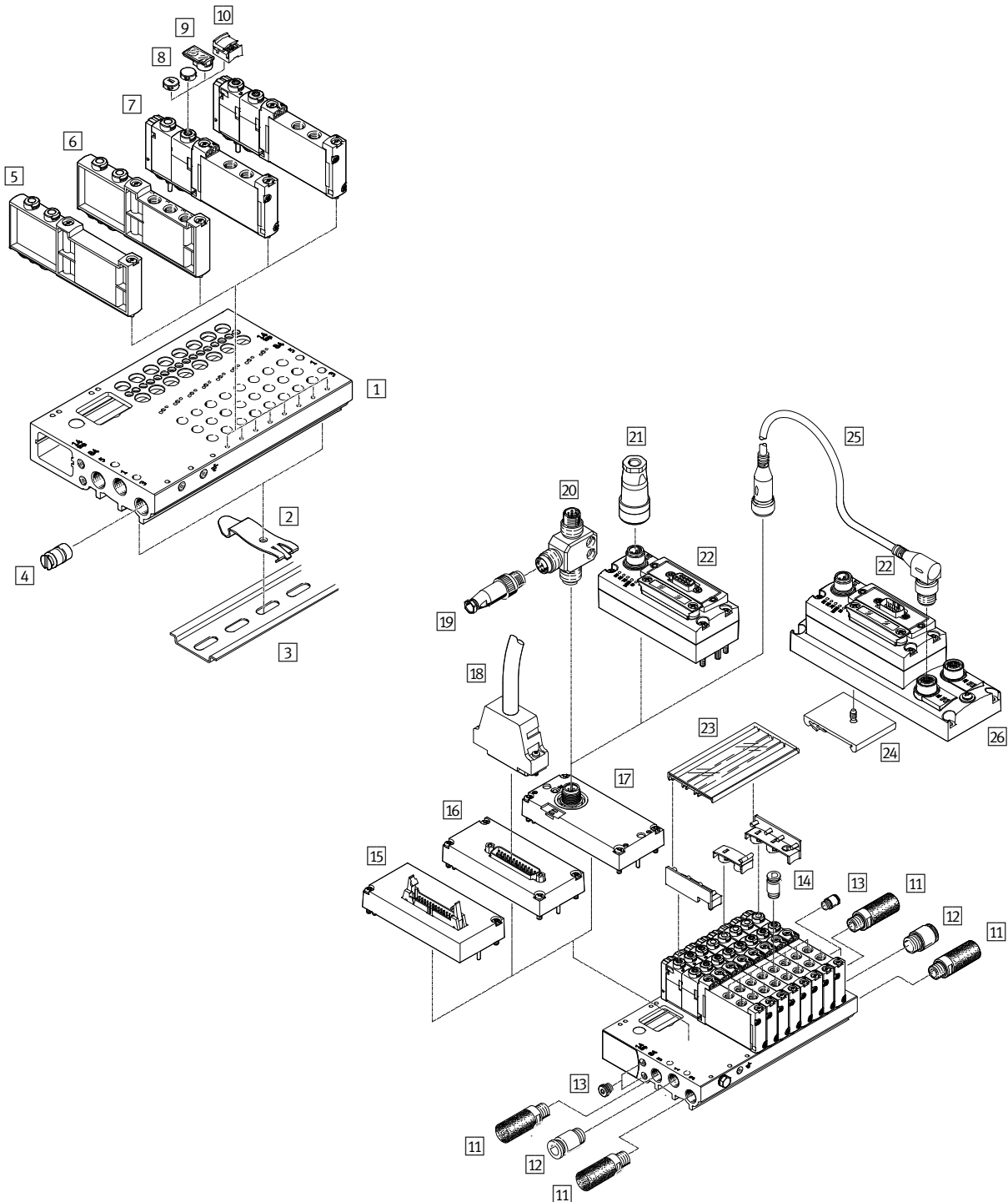

Valve terminals VTUG with multi-pin plug and fieldbus connection

Peripherals overview example – Semi in-line valves

Accessories				
	Type	Brief description	→ Page/Internet	
1	Manifold rail	VABM-L1-...	For 4 to 10, 12, 16, 20 and 24 valve positions	155
2	H-rail mounting	VAME-T-M4	2 pieces for fitting the valve terminal on an H-rail	188
3	H-rail	NRH-35-2000	For mounting the valve terminal	188
4	Separator	VABD-...	For creating pressure zones	187
5	Blanking plate	VABB-L1-...	For covering an unused valve position	187
6	Supply plate	VABF-L1-...	For air supply at port 1 and ports 3 and 5	187
7	Solenoid valve	VUVG-...	Semi in-line valve	131, 136, 140
8	Cover cap	VMPPA-HB...-B	For manual override	187
9	Inscription label holder	ASLR-D-L1	For inscription label and covering the mounting screw/manual override	188
10	Cover	VAMC-...	For manual override	187
11	Silencer	U-...	For ports 3 and 5	187
12	Push-in fitting	QS-...	For air supply, port 1	186
13	Blanking plug	B-...	For internal/external pilot air	186
14	Push-in fitting	QS-...	For ports 2 and 4	186
15	Electrical interface	VAEM-L1-S-M3-...	Flat cable	176
16	Electrical interface	VAEM-L1-S-M1-...	Sub-D	176
17	Electrical interface	VAEM-L1-S-...-PT	I-Port interface/IO-Link	179
18	Connecting cable	NEBV-...	Sub-D cable	176
19	Plug connector	SEA-M12-5GS-PG7	Straight, for T-adaptor FB-TA	179
20	T-adaptor	FB-TA-M12-5POL	For IO-Link and load voltage supply	179
21	Power supply socket	NTSD-.../FBSD-...	Power supply for CTEU bus nodes	185
22	CTEU	CTEU-...	Bus node	185
23	Inscription label holder	ASCF-H-L1	For identifying valves	188
24	H-rail mounting	CAF-M-F1-H	For connecting block CAPC	181
25	Connecting cable	NEBU-...	-	nebu
26	Connecting block	CAPC-F1-E-M12	For connecting a second device with I-Port interface	181

Valve terminals VTUG with multi-pin plug and fieldbus connection

Peripherals overview example – Sub-base valves

Valve terminal overview – Multi-pin plug and I-Port interface

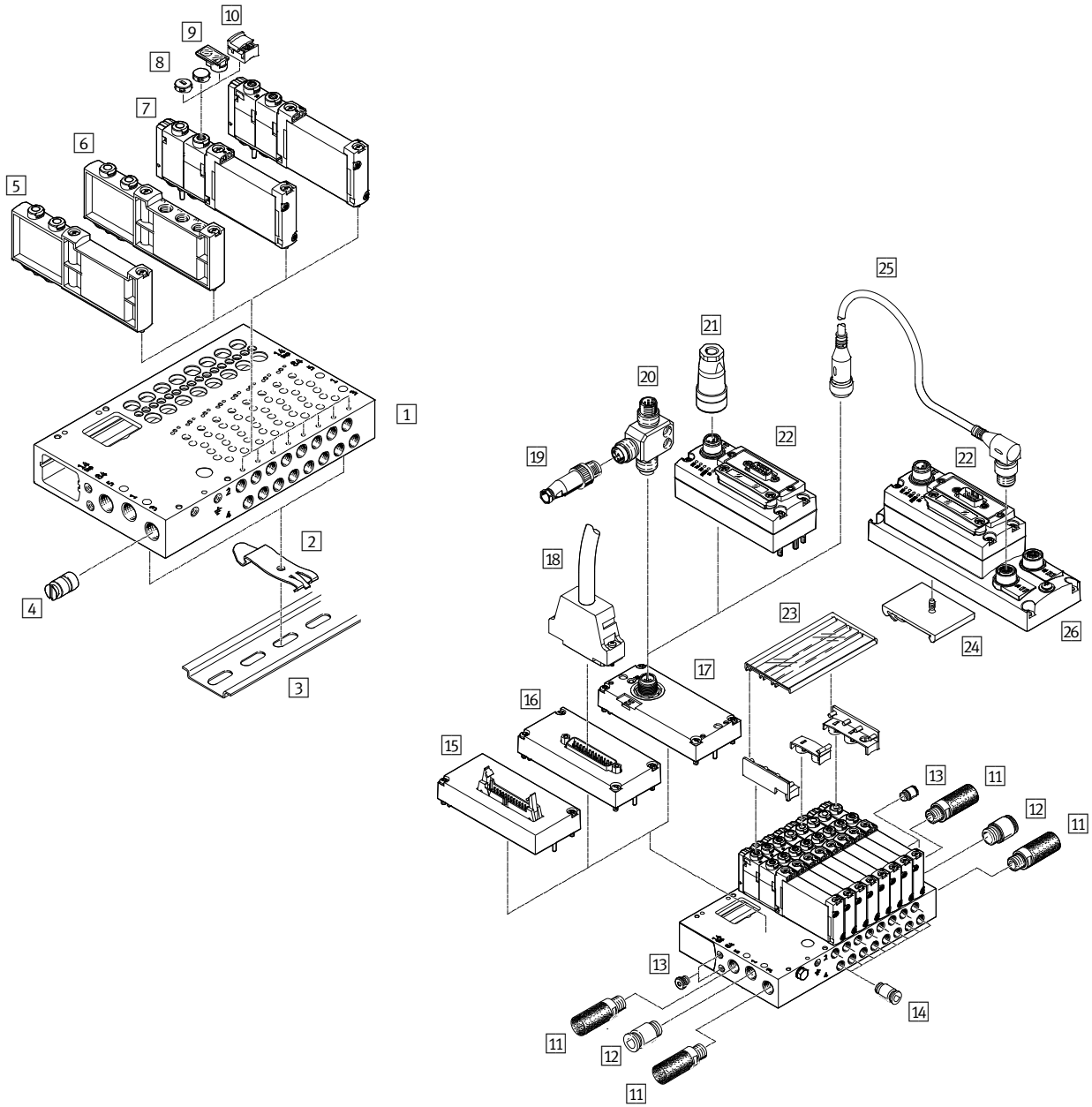

Valve terminals VTUG with multi-pin plug and fieldbus connection

Peripherals overview example – Sub-base valves

Accessories				
	Type	Brief description	→ Page/Internet	
1	Manifold rail	VABM-L1-...	For 4 to 10, 12, 16, 20 and 24 valve positions	155
2	H-rail mounting	VAME-T-M4	2 pieces for fitting the valve terminal on an H-rail	188
3	H-rail	NRH-35-2000	For mounting the valve terminal	188
4	Separator	VABD-...	For creating pressure zones	187
5	Blanking plate	VABB-L1-...	For covering an unused valve position	187
6	Supply plate	VABF-L1-...	For air supply at port 1 and ports 3 and 5	187
7	Solenoid valve	VUVG- ...	Sub-base valve	144, 148, 152
8	Cover cap	VMPPA-HB...-B	For manual override	187
9	Inscription label holder	ASLR-D-L1	For inscription label and covering the mounting screw/manual override	188
10	Cover	VAMC...	For manual override	187
11	Silencer	U...	For ports 3 and 5	187
12	Push-in fitting	QS...	For air supply, port 1	186
13	Blanking plug	B-...	For internal/external pilot air	186
14	Push-in fitting	QS...	For ports 2 and 4	186
15	Electrical interface	VAEM-L1-S-M3-...	Flat cable	176
16	Electrical interface	VAEM-L1-S-M1-...	Sub-D	176
17	Electrical interface	VAEM-L1-S-...-PT	I-Port interface/IO-Link	179
18	Connecting cable	NEBV-...	Sub-D cable	176
19	Plug connector	SEA-M12-5GS-PG7	Straight, for T-adaptor FB-TA	179
20	T-adaptor	FB-TA-M12-5POL	For IO-Link and load voltage supply	179
21	Power supply socket	FBSD-.../NTSD-...	Power supply for CTEU bus nodes	185
22	CTEU	CTEU-...	Bus node	185
23	Inscription label holder	ASCF-H-L1	For identifying valves	188
24	H-rail mounting	CAFM-F1-H	For connecting block CAPC	181
25	Connecting cable	NEBU-...	-	nebu
26	Connecting block	CAPC-F1-E-M12	For connecting a second device with I-Port interface	181

Valve terminals VTUG with multi-pin plug and fieldbus connection

Peripherals overview example – Sub-base valves

Valve terminal overview – I-Port interface with interlock

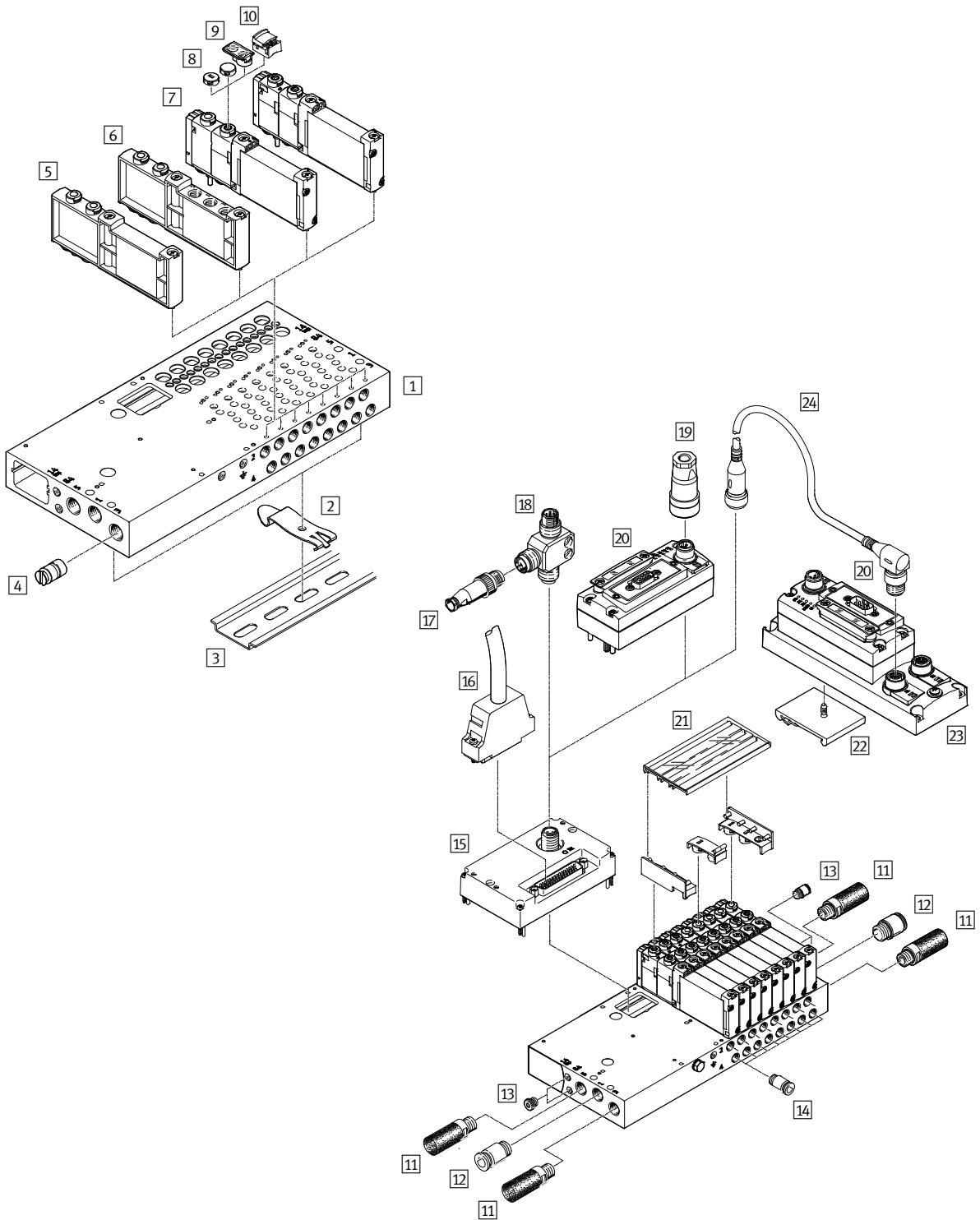

Valve terminals VTUG with multi-pin plug and fieldbus connection

Peripherals overview example – Sub-base valves

Accessories				
	Type	Brief description	→ Page/Internet	
1	Manifold rail	VABM-L1-...	For 4 to 10, 12, 16, 20 and 24 valve positions	155
2	H-rail mounting	VAME-T-M4	2 pieces for fitting the valve terminal on an H-rail	188
3	H-rail	NRH-35-2000	For mounting the valve terminal	188
4	Separator	VABD-...	For creating pressure zones	187
5	Blanking plate	VABB-L1-...	For covering an unused valve position	187
6	Supply plate	VABF-L1-...	For air supply at port 1 and ports 3 and 5	187
7	Solenoid valve	VUVG-...	–	144, 148, 152
8	Cover cap	VMPPA-HB...-B	For manual override	187
9	Inscription label holder	ASLR-D-L1	For inscription label and covering the mounting screw/manual override	188
10	Cover	VAMC-...	For manual override	187
11	Silencer	U-...	For ports 3 and 5	187
12	Push-in fitting	QS-...	For air supply, port 1	186
13	Blanking plug	B-...	For internal/external pilot air	186
14	Push-in fitting	QS-...	For ports 2 and 4	186
15	Electrical interface	VAEM-L1-S-24-...	I-Port interface with interlock	vtug, 182
16	Connecting cable	NEBV-...	Sub-D cable	176
17	Plug connector	SEA-M12-5GS-PG7	Straight, for T-adapter FB-TA	179
18	T-adapter	FB-TA-M12-5POL	For IO-Link and load voltage supply	179
19	Power supply socket	NTSD-.../FBSD-...	Power supply for CTEU bus nodes	185
20	CTEU	CTEU-...	Bus node	185
21	Inscription label holder	ASCF-H-L1	For identifying valves	188
22	H-rail mounting	CAF-M-F1-H	For connecting block CAPC	181
23	Connecting block	CAPC-F1-E-M12	For connecting a second device with I-Port interface	181
24	Connecting cable	NEBU-...	–	nebu

Valve terminals VTUG with multi-pin plug and fieldbus connection

Peripherals overview example – Sub-base valves

Valve terminal with multi-pin plug/fieldbus connection and individually electrically actuated valves

In applications with specific emergency off requirements, it may be necessary to switch one or more valves separately from the valve terminal controller.

Valves VUVG (see → page 9) with individual electrical connection are mounted on the valve terminal to this end.

Valves with individual electrical connection require a special seal when mounted within a valve terminal.

They are therefore ordered/fitted as follows:

- together with the valve terminal using the valve terminal configurator
- individually/subsequently as a substitute for a blanking plate in a vacant position

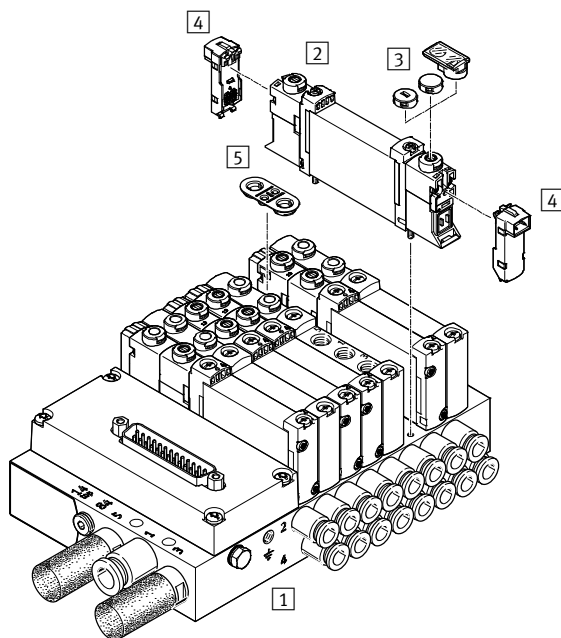

Accessories				
	Type	Brief description	→ Page/Internet	
1	Manifold rail	VABM-L1-10	For 2 to 10, 12 and 16 valve positions	155
2	Solenoid valve	VUVG	Sub-base valve	75
3	Cover cap	VMPA	For manual override	107
4	E-box	VAVE	For individual connection	101
5	Seal	–	Included in the scope of delivery of the blanking plate for a vacant position	187

Valve terminals VTUG with multi-pin plug and fieldbus connection

FESTO

Order code – Semi in-line valves M5/M7

VUVG	-	S	10	-	-
Valve design					
Semi in-line valve					
Width					
10 mm					
Valve functions					
					M52
					B52
					P53C
					P53U
					P53E
					T32C
					T32H
					T32U

Z	-	1	T1	L
Display				
L LED				
Electrical connection				
T1 Plug-in				
Nominal operating voltage				
1 24 V DC				
Pneumatic connection				
M5 M5 thread				
M7 M7 thread				
Q3 Push-in connector 3 mm				
Q4 Push-in connector 4 mm				
Q4H Push-in connector 4 mm, M7				
Q6 Push-in connector 6 mm				
Q6H Push-in connector 6 mm, M7				
T14 Push-in connector 1/4"				
T14H Push-in connector 1/4", M7				
T18 Push-in connector 1/8"				
T316 Push-in connector 3/16"				
T316H Push-in connector 3/16", M7				
T532 Push-in connector 5/32"				
Manual override				
H Non-detenting				
S Covered				
T Non-detenting, detenting				
Y Detenting, without accessories				
Pilot air				
Z External				
Reset method				
A Pneumatic spring with T32				
M Mechanical spring with T32 and M52				
R Pneumatic/mechanical spring with M52				
-				

Valve terminals VTUG with multi-pin plug and fieldbus connection

Technical data – Semi in-line valves M5/M7

Function

2x3/2C, 2x3/2U, 2x3/2H

5/2-way, single solenoid

5/2-way, double solenoid

5/3C, 5/3U, 5/3E

Circuit symbol → page 11

-  - Width 10 mm

-  - Flow rate
130 ... 330 l/min

-  - Voltage
24 V DC



General technical data												
Valve function	T32-A			T32-M			M52-R	B52	M52-M	P53		
Normal position	C ¹⁾	U ²⁾	H ⁴⁾	C ¹⁾	U ²⁾	H ⁴⁾	–	–	–	C ¹⁾	U ²⁾	E ³⁾
Stable position	Single solenoid							Double solenoid	Single solenoid			
Reset method: pneumatic spring	Yes			No			Yes ⁵⁾	–	No	–		
Reset method: mechanical spring	No			Yes			Yes ⁵⁾	–	Yes	–		
Vacuum operation at port 1	No			With external pilot air								
Design	Piston spool valve											
Sealing principle	Soft											
Actuation type	Electrical											
Type of control	Piloted											
Pilot air supply	External											
Exhaust function	With flow control											
Manual override	Choice of non-detenting, covered, non-detenting/detenting or detenting											
Type of mounting	On manifold rail											
Mounting position	Any											
Switching position display	LED											
Flow rate on manifold rail M5	[l/min]	150			130			230		210		
Flow rate on manifold rail M7	[l/min]	160			140			330		290	280	
Width	[mm]	10										
Port	1, 3, 5, 12/14, 82/84	On manifold rail										
	2, 4	M5 (VUVG-S10-...-M5) M7 (VUVG-S10-...-M7)										
Product weight	[g]	59					53	60	53	58		
Approval	c UL us - Recognized (OL)											
	c CSA us (OL)											
CE marking (see declaration of conformity)	To EU EMC Directive ⁶⁾											
Corrosion resistance class CRC ⁷⁾	2											

1) C=Normally closed/mid-position closed

2) U=Normally open/mid-position pressurised

3) E=Mid-position exhausted

4) H=2x 3/2-way valve in one housing with 1x normally closed and 1x normally open

5) Combined reset method

6) For information about the applicability of the component see the manufacturer's EC declaration of conformity at: www.festo.com/sp → Certificates.

If the component is subject to restrictions on usage in residential, office or commercial environments or small businesses, further measures to reduce the emitted interference may be necessary.

7) Corrosion resistance class 2 according to Festo standard 940 070

Components subject to moderate corrosion stress. Externally visible parts with primarily decorative surface requirements which are in direct contact with a normal industrial environment or media such as coolants or lubricating agents.

Valve terminals VTUG with multi-pin plug and fieldbus connection

FESTO

Technical data – Semi in-line valves M5/M7

Operating and environmental conditions									
Valve function			T32-A ¹⁾	T32-M ³⁾	M52-R ²⁾	B52	M52-M ³⁾	P53	
Operating medium			Compressed air to ISO 8573-1:2010 [7:4:4]						
Operating pressure	Internal pilot air supply	[bar]	1.5 ... 8	2 ... 8	2.5 ... 8	1.5 ... 8	3 ... 8	3 ... 8	
	External pilot air supply	[bar]	1.5 ... 10	-0.9 ... 10			-0.9 ... 8	-0.9 ... 10	
Pilot pressure ⁴⁾		[bar]	1.5 ... 8	2 ... 8	2.5 ... 8	1.5 ... 8	3 ... 8	3 ... 8	
Ambient temperature		[°C]	-5 ... +60						
Temperature of medium		[°C]	-5 ... +60						

- 1) Pneumatic spring
- 2) Mixed, pneumatic/mechanical spring
- 3) Mechanical spring
- 4) Minimum pilot pressure 50% of operating pressure

Electrical data		
Electrical connection		Via E-box
Operating voltage	[V DC]	24 ±10%
Power consumption per valve solenoid	[W]	1/0.4 (after 25 ms)
Duty cycle ED	[%]	100
Max. switching frequency	[Hz]	3
Degree of protection to EN 60529	Valve	IP67/IP65
	Valve terminal	IP40, IP67/IP65

Safety characteristics	
Note on forced checking procedure	Min. 1/week
Max. positive test pulse with 0 signal	[µs] 1600
Max. negative test pulse with 1 signal	[µs] 3000
Resistance to shocks	Shock test with severity level 2 to FN 942017-5 and EN 60068-2-27
Vibration resistance	Transport application test with severity level 2 to FN 942017-4 and EN 60068-2-6

Information on materials	
Housing	Wrought aluminium alloy
Seals	HNBR, NBR
Note on materials	RoHS compliant

Valve switching times								
Valve function			T32-A ¹⁾	T32-M ³⁾	M52-R ²⁾	B52	M52-M ³⁾	P53
Switching time on	[ms]		8	10	9	–	12	12
Switching time off	[ms]		20	20	21	–	30	38
Changeover time	[ms]		–	–	–	9	–	16

- 1) Pneumatic spring
- 2) Mixed, pneumatic/mechanical spring
- 3) Mechanical spring

Valve terminals VTUG with multi-pin plug and fieldbus connection

Technical data – Semi in-line valves M5/M7

Dimensions

Download CAD data → www.festo.com

Semi in-line valves M5/M7

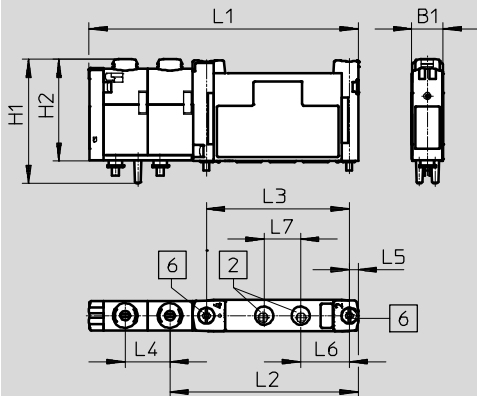

- 2 Ports 2 and 4 M5/M7
- 6 Mounting screw

Type	B1	H1	H2	L1	L2	L3	L4	L5	L6	L7
VUVG-S10-...-M5-1T1L	10.3	40.9	33.6	88.6	62	47	14.7	3	16	12
VUVG-S10-...-M7-1T1L										

Ordering data

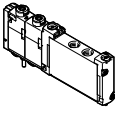
Description	Part No.	Type	
Semi in-line valve M5			
	2x3/2-way valve		
	External pilot air supply	Normally closed, reset method: pneumatic spring	573386 VUVG-S10-T32C-AZT-M5-1T1L
		Normally open, reset method: pneumatic spring	573387 VUVG-S10-T32U-AZT-M5-1T1L
		1x normally open, 1x normally closed, reset method: pneumatic spring	573388 VUVG-S10-T32H-AZT-M5-1T1L
		Normally closed, reset method: mechanical spring	573389 VUVG-S10-T32C-MZT-M5-1T1L
		Normally open, reset method: mechanical spring	573390 VUVG-S10-T32U-MZT-M5-1T1L
		1x normally open, 1x normally closed, reset method: mechanical spring	573391 VUVG-S10-T32H-MZT-M5-1T1L
	5/2-way valve, single solenoid		
	External pilot air supply	Reset method: mechanical spring	573393 VUVG-S10-M52-MZT-M5-1T1L
		Reset method: pneumatic/mechanical spring	573392 VUVG-S10-M52-RZT-M5-1T1L
	5/2-way valve, double solenoid		
External pilot air supply		573394 VUVG-S10-B52-ZT-M5-1T1L	
5/3-way valve			
External pilot air supply	Mid-position closed	573395 VUVG-S10-P53C-ZT-M5-1T1L	
	Mid-position pressurised	573397 VUVG-S10-P53U-ZT-M5-1T1L	
	Mid-position exhausted	573396 VUVG-S10-P53E-ZT-M5-1T1L	

Valve terminals VTUG with multi-pin plug and fieldbus connection

FESTO

Ordering data

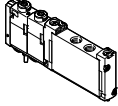
Ordering data					
		Description	Part No.	Type	
Semi in-line valve M7					
	2x3/2-way valve				
	External pilot air supply	Normally closed, reset method: pneumatic spring	573398	VUVG-S10-T32C-AZT-M7-1T1L	
		Normally open, reset method: pneumatic spring	573399	VUVG-S10-T32U-AZT-M7-1T1L	
		1x normally open, 1x normally closed, reset method: pneumatic spring	573400	VUVG-S10-T32H-AZT-M7-1T1L	
		Normally closed, reset method: mechanical spring	573401	VUVG-S10-T32C-MZT-M7-1T1L	
		Normally open, reset method: mechanical spring	573402	VUVG-S10-T32U-MZT-M7-1T1L	
		1x normally open, 1x normally closed, reset method: mechanical spring	573403	VUVG-S10-T32H-MZT-M7-1T1L	
	5/2-way valve, single solenoid				
	External pilot air supply	Reset method: mechanical spring	573405	VUVG-S10-M52-MZT-M7-1T1L	
		Reset method: pneumatic/mechanical spring	573404	VUVG-S10-M52-RZT-M7-1T1L	
	5/2-way valve, double solenoid				
	External pilot air supply		573406	VUVG-S10-B52-ZT-M7-1T1L	
	5/3-way valve				
	External pilot air supply	Mid-position closed	573407	VUVG-S10-P53C-ZT-M7-1T1L	
Mid-position pressurised		573409	VUVG-S10-P53U-ZT-M7-1T1L		
Mid-position exhausted		573408	VUVG-S10-P53E-ZT-M7-1T1L		

Valve terminals VTUG with multi-pin plug and fieldbus connection

Order code – Semi in-line valves G1/8

VUVG	-	S	14	-	
Valve design					
Semi in-line valve			S		
Width					
14 mm			14		
Valve functions					
				M52	
				B52	
				P53C	
				P53U	
				P53E	
				T32C	
				T32H	
				T32U	

Z	-			1	T1	L
Display						
					L	LED
Electrical connection						
					T1	Plug-in
Nominal operating voltage						
1					24 V DC	
Pneumatic connection						
G18		G1/8 thread				
T18		Push-in connector 1/8"				
T14		Push-in connector 1/4"				
T516		Push-in connector 5/16"				
Q4		Push-in connector 4 mm				
Q6		Push-in connector 6 mm				
Q8		Push-in connector 8 mm				
Manual override						
H		Non-detenting				
S		Covered				
T		Non-detenting, detenting				
Y		Detenting, without accessories				
Pilot air						
Z		External				
Reset method						
A		Pneumatic spring with M52 and T32				
M		Mechanical spring with M52 and T32				
-		With B52 and P53				

Valve terminals VTUG with multi-pin plug and fieldbus connection

FESTO

Technical data – Semi in-line valves G1/8

Function

2x3/2C, 2x3/2U, 2x3/2H

5/2-way, single solenoid

5/2-way, double solenoid

5/3C, 5/3U, 5/3E

Circuit symbol → page 11

-  - Width 14 mm

-  - Flow rate
520 ... 630 l/min

-  - Voltage
24 V DC



General technical data											
Valve function	T32-A			T32-M			M52-A	B52	M52-M	P53	
Normal position	C ¹⁾	U ²⁾	H ⁴⁾	C ¹⁾	U ²⁾	H ⁴⁾	-	-	-	C ¹⁾ U ²⁾ E ³⁾	
Stable position	Single solenoid							Double solenoid	Single solenoid		
Reset method: pneumatic spring	Yes			No			Yes	-	No	-	
Reset method: mechanical spring	No			Yes			No	-	Yes	-	
Vacuum operation at port 1	No			With external pilot air							
Design	Piston spool valve										
Sealing principle	Soft										
Actuation type	Electrical										
Type of pilot control	Piloted										
Pilot air supply	External										
Exhaust function	With flow control										
Manual override	Choice of non-detenting, covered, non-detenting/detenting or detenting										
Type of mounting	On manifold rail										
Mounting position	Any										
Switching position display	LED										
Flow rate on manifold rail G ^{1/8}	[l/min]	610			520			620	630	620	590
Width	[mm]	14									
Port	1, 3, 5, 12/14, 82/84	On manifold rail									
	2, 4	G ^{1/8}									
Product weight	[g]	102			100			91	98	89	95
Approval	c UL us - Recognized (OL)										
	c CSA us (OL)										
CE marking (see declaration of conformity)	To EU EMC Directive ⁵⁾										
Corrosion resistance class CRC ⁶⁾	2										

1) C=Normally closed/mid-position closed

2) U=Normally open/mid-position pressurised

3) E=Mid-position exhausted

4) H=2x 3/2-way valve in one housing with 1x normally closed and 1x normally open

5) For information about the applicability of the component see the manufacturer's EC declaration of conformity at: www.festo.com/sp → Certificates.

If the component is subject to restrictions on usage in residential, office or commercial environments or small businesses, further measures to reduce the emitted interference may be necessary.

6) Corrosion resistance class 2 according to Festo standard 940 070

Components subject to moderate corrosion stress. Externally visible parts with primarily decorative surface requirements which are in direct contact with a normal industrial environment or media such as coolants or lubricating agents.

Valve terminals VTUG with multi-pin plug and fieldbus connection

FESTO

Technical data – Semi in-line valves G1/8

Operating and environmental conditions								
Valve function			T32-A ¹⁾	T32-M ²⁾	M52-A ¹⁾	B52	M 52-M ²⁾	P53
Operating medium		Compressed air to ISO 8573-1:2010 [7:4:4]						
Operating pressure	Internal pilot air supply	[bar]	1.5 ... 8	2 ... 8	2.5 ... 8	1.5 ... 8	3 ... 8	3 ... 8
	External pilot air supply	[bar]	1.5 ... 10	-0.9 ... 10			-0.9 ... 8	-0.9 ... 10
Pilot pressure ³⁾		[bar]	1.5 ... 8	2 ... 8	2.5 ... 8	1.5 ... 8	3 ... 8	3 ... 8
Ambient temperature		[°C]	-5 ... +60					
Temperature of medium		[°C]	-5 ... +60					

1) Pneumatic spring

2) Mechanical spring

3) Minimum pilot pressure 50% of operating pressure

Electrical data		
Electrical connection		Via E-box
Operating voltage	[V DC]	24 ±10%
Power	[W]	1/0.4 (after 25 ms)
Duty cycle ED	[%]	100
Max. switching frequency	[Hz]	3
Degree of protection to EN 60529	Valve	IP67/IP65
	Valve terminal	IP40, IP67/IP65

Safety characteristics		
Note on forced checking procedure		Min. 1/week
Max. positive test pulse with 0 signal	[µs]	1600
Max. negative test pulse with 1 signal	[µs]	3000
Resistance to shocks		Shock test with severity level 2 to FN 942017-5 and EN 60068-2-27
Vibration resistance		Transport application test with severity level 2 to FN 942017-4 and EN 60068-2-6

Information on materials	
Housing	Wrought aluminium alloy
Seals	HNBR, NBR
Note on materials	
RoHS compliant	

Valve switching times								
Valve function			T32-A ¹⁾	T32-M ²⁾	M52-A ¹⁾	B52	M 52-M ²⁾	P53
Switching time on	[ms]	10	13	13	–	10	15	
Switching time off	[ms]	29	21	26	–	38	42	
Changeover time	[ms]	–	–	–	9	–	25	

1) Pneumatic spring

2) Mechanical spring

Valve terminals VTUG with multi-pin plug and fieldbus connection

FESTO

Technical data – Semi in-line valves G1/8

Dimensions Download CAD data → www.festo.com

Semi in-line valves G1/8

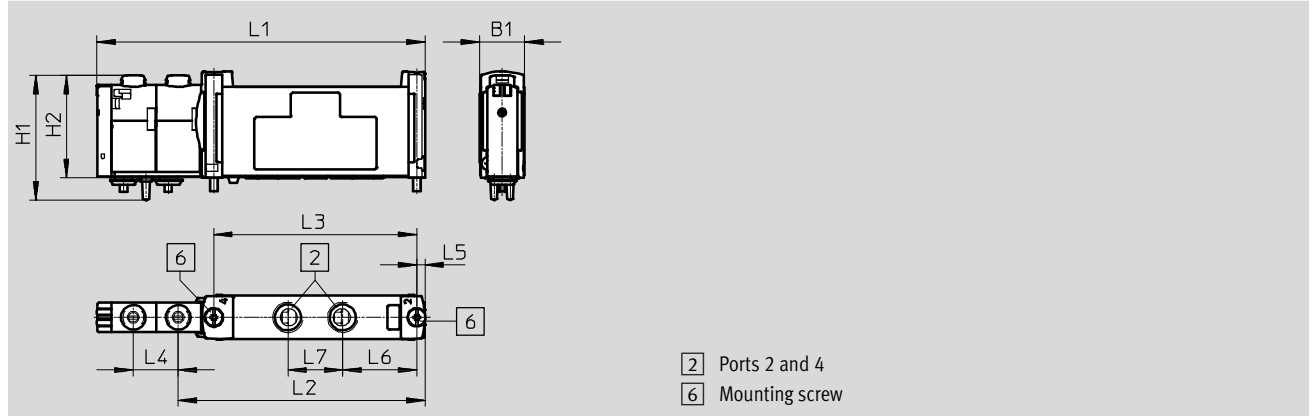

Type	B1	H1	H2	L1	L2	L3	L4	L5	L6	L7
VUVG-S14-...-G18-1T1L	14.7	40.9	33.5	107.6	81	66.5	14.7	2.8	24.3	18

Ordering data		Description	Part No.	Type
Semi in-line valve G1/8				
	2x3/2-way valve			
	External pilot air supply	Normally closed, reset method: pneumatic spring	573464	VUVG-S14-T32C-AZT-G18-1T1L
		Normally open, reset method: pneumatic spring	573465	VUVG-S14-T32U-AZT-G18-1T1L
		1x normally open, 1x normally closed, reset method: pneumatic spring	573466	VUVG-S14-T32H-AZT-G18-1T1L
		Normally closed, reset method: mechanical spring	573467	VUVG-S14-T32C-MZT-G18-1T1L
		Normally open, reset method: mechanical spring	573468	VUVG-S14-T32U-MZT-G18-1T1L
		1x normally open, 1x normally closed, reset method: mechanical spring	573469	VUVG-S14-T32H-MZT-G18-1T1L
	5/2-way valve, single solenoid			
	External pilot air supply	Reset method: pneumatic spring	573470	VUVG-S14-M52-AZT-G18-1T1L
		Reset method: mechanical spring	573471	VUVG-S14-M52-MZT-G18-1T1L
5/2-way valve, double solenoid				
External pilot air supply		573472	VUVG-S14-B52-ZT-G18-1T1L	
5/3-way valve				
External pilot air supply	Mid-position closed	573473	VUVG-S14-P53C-ZT-G18-1T1L	
	Mid-position pressurised	573475	VUVG-S14-P53U-ZT-G18-1T1L	
	Mid-position exhausted	573474	VUVG-S14-P53E-ZT-G18-1T1L	

Valve terminals VTUG with multi-pin plug and fieldbus connection

Order code – Semi in-line valves G1/4

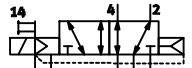
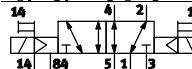
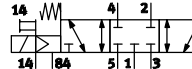
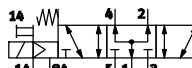
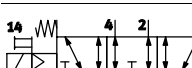
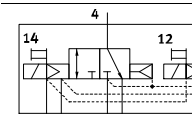
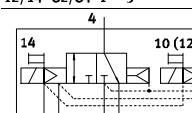
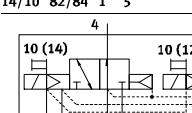
VUVG	-	S	18	-
Valve design				
Semi in-line valve			S	
Width				
18 mm			18	
Valve functions				
				M52
				B52
				P53C
				P53U
				P53E
				T32C
				T32H
				T32U

Z	-	1	T1	L
Display				
			L	LED
Electrical connection				
			T1	Plug-in
Nominal operating voltage				
1			24 V DC	
Pneumatic connection				
G14	G1/4 thread			
Q6	Push-in connector 6 mm			
Q8	Push-in connector 8 mm			
Q10	Push-in connector 10 mm			
T14	Push-in connector 1/4"			
T516	Push-in connector 5/16"			
T38	Push-in connector 3/8"			
Manual override				
H	Non-detenting			
S	Covered			
T	Non-detenting, detenting			
Y	Detenting, without accessories			
Pilot air				
Z	External			
Reset method				
A	Pneumatic spring with T32			
M	Mechanical spring with M52 and T32			
R	Pneumatic/mechanical spring with M52			
-	With B52 and P53			



Valve terminals VTUG with multi-pin plug and fieldbus connection

Technical data – Semi in-line valves G1/4

Function

2x3/2C, 2x3/2U, 2x3/2H
 5/2-way, single solenoid
 5/2-way, double solenoid
 5/3C, 5/3U, 5/3E

Circuit symbol → page 11

-  - Width 18 mm
-  - Flow rate
900 ... 1200 l/min
-  - Voltage
24 V DC

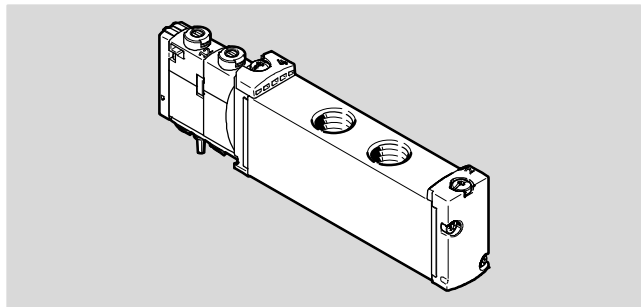

General technical data										
Valve function	T32-A			T32-M			M52-R	B52	M52-M	P53
Normal position	C ¹⁾	U ²⁾	H ⁴⁾	C ¹⁾	U ²⁾	H ⁴⁾	-	-	-	C ¹⁾ U ²⁾ E ³⁾
Stable position	Single solenoid							Double solenoid	Single solenoid	
Reset method: pneumatic spring	Yes			No			Yes ⁵⁾	-	No	-
Reset method: mechanical spring	No			Yes			Yes ⁵⁾	-	Yes	-
Vacuum operation at port 1	No			With external pilot air						
Design	Piston spool valve									
Sealing principle	Soft									
Actuation type	Electrical									
Type of control	Piloted									
Pilot air supply	External									
Exhaust function	With flow control									
Manual override	Choice of non-detenting, covered, non-detenting/detenting or detenting									
Type of mounting	On manifold rail									
Mounting position	Any									
Switching position display	LED									
Flow rate on manifold rail G ^{1/8}	[l/min]	900	900	1150	1200	1150	1000			
Width	[mm]	18								
Port	1, 3, 5, 12/14, 82/84	On manifold rail								
	2, 4	G ^{1/4}								
Product weight	[g]	145	147	138	145	138	140			
Approval certificate	c UL us - Recognized (OL)									
	c CSA us (OL)									
CE marking (see declaration of conformity)	To EU EMC Directive ⁶⁾									
Corrosion resistance class CRC ⁷⁾	2									

1) C=Normally closed/mid-position closed
 2) U=Normally open/mid-position pressurised
 3) E=Mid-position exhausted
 4) H=2x 3/2-way valve in one housing with 1x normally closed and 1x normally open
 5) Combined reset method
 6) For information about the applicability of the component see the manufacturer's EC declaration of conformity at: www.festo.com/sp → Certificates.
 If the component is subject to restrictions on usage in residential, office or commercial environments or small businesses, further measures to reduce the emitted interference may be necessary.
 7) Corrosion resistance class 2 according to Festo standard 940 070
 Components subject to moderate corrosion stress. Externally visible parts with primarily decorative surface requirements which are in direct contact with a normal industrial environment or media such as coolants or lubricating agents.

Valve terminals VTUG with multi-pin plug and fieldbus connection

Technical data – Semi in-line valves G1/4

Operating and environmental conditions							
Valve function		T32-A ¹⁾	T32-M ²⁾	M52-R ³⁾	B52	M52-M ²⁾	P53
Operating medium		Compressed air to ISO 8573-1:2010 [7:4:4]					
Pilot medium		Compressed air to ISO 8573-1:2010 [7:4:4]					
Note on operating/pilot medium		Lubricated operation possible (in which case lubricated operation will always be required)					
Operating pressure	Internal pilot air supply [bar]	1.5 ... 8	2 ... 8	2.5 ... 8	1.5 ... 8	3 ... 8	3 ... 8
	External pilot air supply [bar]	1.5 ... 10	-0.9 ... 10				-0.9 ... 8
Pilot pressure ⁴⁾	[bar]	1.5 ... 8	2 ... 8	2.5 ... 8	1.5 ... 8	3 ... 8	3 ... 8
Ambient temperature	[°C]	-5 ... +60					
Temperature of medium	[°C]	-5 ... +60					

- 1) Pneumatic spring
- 2) Mechanical spring
- 3) Mixed, pneumatic/mechanical spring
- 4) Minimum pilot pressure 50% of operating pressure

Electrical data		
Electrical connection		Via E-box
Operating voltage	[V DC]	24 ±10%
Power	[W]	1
Duty cycle ED	[%]	100
Max. switching frequency	[Hz]	3
Degree of protection to EN 60529	Valve	IP67/IP65
	Valve terminal	IP40, IP67/IP65

Safety characteristics	
Note on forced checking procedure	Min. 1/week
Max. positive test pulse with 0 signal [µs]	1600
Max. negative test pulse with 1 signal [µs]	3000
Resistance to shocks	Shock test with severity level 2 to FN 942017-5 and EN 60068-2-27
Vibration resistance	Transport application test with severity level 2 to FN 942017-4 and EN 60068-2-6

Information on materials	
Housing	Wrought aluminium alloy
Seals	HNBR, NBR
Note on materials	RoHS compliant

Valve switching times							
Valve function		T32-A ¹⁾	T32-M ²⁾	M52-R ³⁾	B52	M52-M ²⁾	P53
Switching time on [ms]		15	25	20	–	13	20
Switching time off [ms]		35	33	35	–	50	57
Changeover time [ms]		–	–	–	15	–	31

- 1) Pneumatic spring
- 2) Mechanical spring
- 3) Mixed, pneumatic/mechanical spring

Valve terminals VTUG with multi-pin plug and fieldbus connection

Technical data – Semi in-line valves G1/4

Dimensions Download CAD data → www.festo.com

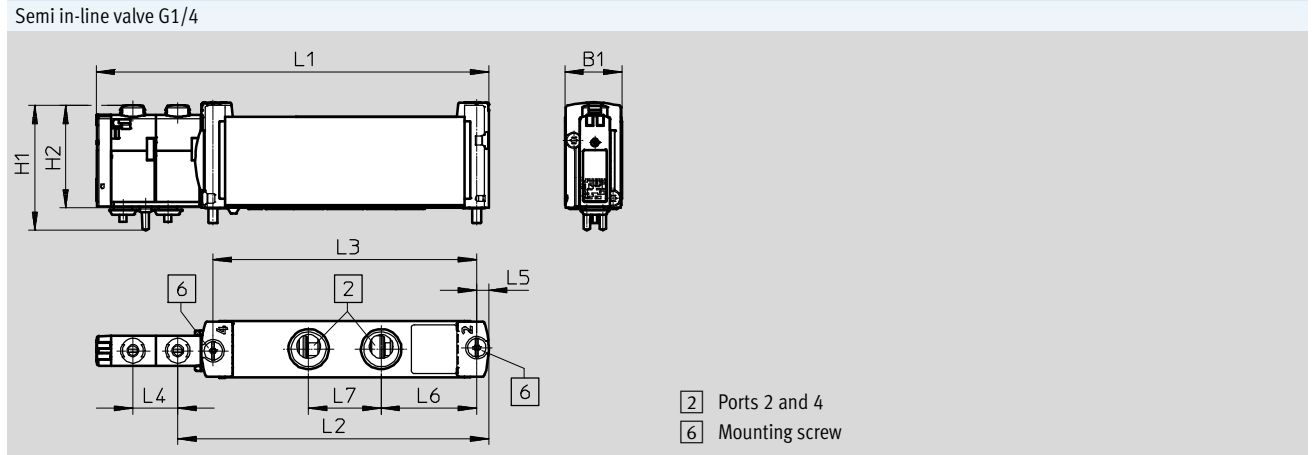

Type	B1	H1	H2	L1	L2	L3	L4	L5	L6	L7
VUVG-S18-...-G14-1T1L	18.7	40.9	33.6	128.6	101.9	86.4	14.7	3.9	31.3	23.8

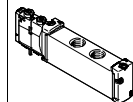
Ordering data		Description	Part No.	Type
Semi in-line valve G1/4				
	2x3/2-way valve			
	External pilot air supply	Normally closed	8004873	VUVG-S18-T32C-AZT-G14-1T1L
		Normally open, reset method: pneumatic spring	8004874	VUVG-S18-T32U-AZT-G14-1T1L
		1x normally open, 1x normally closed, reset method: pneumatic spring	8004875	VUVG-S18-T32H-AZT-G14-1T1L
		Normally closed, reset method: mechanical spring	8004876	VUVG-S18-T32C-MZT-G14-1T1L
		Normally open, reset method: mechanical spring	8004877	VUVG-S18-T32U-MZT-G14-1T1L
		1x normally open, 1x normally closed, reset method: mechanical spring	8004878	VUVG-S18-T32H-MZT-G14-1T1L
	5/2-way valve, single solenoid			
	External pilot air supply	Reset method: pneumatic/mechanical spring	8004879	VUVG-S18-M52-RZT-G14-1T1L
		Reset method: mechanical spring	8004880	VUVG-S18-M52-MZT-G14-1T1L
5/2-way valve, double solenoid				
External pilot air supply		8004881	VUVG-S18-B52-ZT-G14-1T1L	
5/3-way valve				
External pilot air supply	Mid-position closed	8004882	VUVG-S18-P53C-ZT-G14-1T1L	
	Mid-position pressurised	8004883	VUVG-S18-P53E-ZT-G14-1T1L	
	Mid-position exhausted	8004884	VUVG-S18-P53U-ZT-G14-1T1L	

Valve terminals VTUG with multi-pin plug and fieldbus connection

Order code – Sub-base valves M5/M7

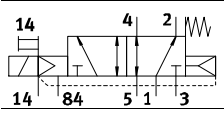
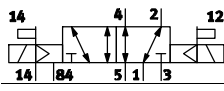
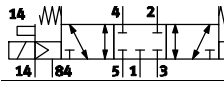
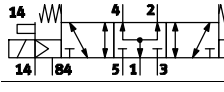
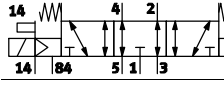
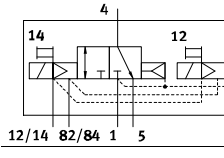
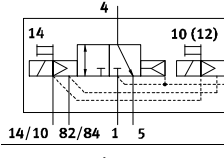
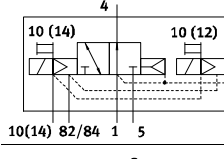
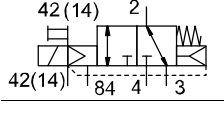
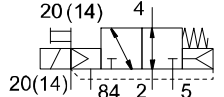
VUVG	-	B	10	-	
Valve design					
Sub-base valves B					
Width					
10 mm 10					
10 mm, 3/2-way valve (M32) 10Z					
Valve functions					
					M52
					B52
					P53C
					P53U
					P53E
					T32C
					T32H
					T32U
					M32C
					M32U



Z	-	F	-	1	T1	L
Display						
L LED						
Electrical connection						
T1 Plug-in						
Nominal operating voltage						
1 24 V DC						
Pneumatic connection						
F Flange/sub-base						
Manual override						
H Non-detenting						
S Covered						
T Non-detenting, detenting						
Y Detenting, without accessories						
Pilot air						
Z External						
Reset method						
A Pneumatic spring with T32						
M Mechanical spring with M52 and T32						
R Pneumatic/mechanical spring with M52 and M32						
- With B52 and P53						

Valve terminals VTUG with multi-pin plug and fieldbus connection

FESTO

Technical data – Sub-base valves M5/M7

Function
3/2C, 3/2U
2x3/2C, 2x3/2U, 2x3/2H
5/2-way, single solenoid
5/2-way, double solenoid
5/3C, 5/3U, 5/3E

-  - Width 10 mm
-  - Flow rate
130 ... 300 l/min
-  - Voltage
24 V DC



Circuit symbol → page 11

General technical data														
Valve function	T32-A			T32-M			M32-R		M52-R	B52	M52-M	P53		
Normal position	C ¹⁾	U ²⁾	H ⁴⁾	C ¹⁾	U ²⁾	H ⁴⁾	C ¹⁾	U ²⁾	-	-	-	C ¹⁾	U ²⁾	E ³⁾
Stable position	Single solenoid									Double solenoid	Single solenoid			
Reset method: pneumatic spring	Yes			No			No		Yes ⁵⁾	-	No	-		
Reset method: mechanical spring	No			Yes			Yes		Yes ⁵⁾	-	Yes	-		
Vacuum operation at port 1	No			With external pilot air										
Design	Piston spool valve													
Sealing principle	Soft													
Actuation type	Electrical													
Type of control	Piloted													
Pilot air supply	External													
Exhaust function	With flow control													
Manual override	Choice of non-detenting, covered, non-detenting/detenting or detenting													
Type of mounting	On manifold rail													
Mounting position	Any													
Switching position display	LED													
Standard nominal flow rate M5/M7	[l/min]	160	140	140	300	260	260							
Flow rate on manifold rail M5, front	[l/min]	150	130	130	220	220	200							
Flow rate on manifold rail M7, front	[l/min]	160	140	140	270	240	250							
Flow rate on manifold rail M7, underneath	[l/min]	160	140	140	300	260	260							
Width	[mm]	10												
Port	1, 3, 5, 12/14, 82/84	On manifold rail												
	2, 4	On manifold rail												
Product weight	[g]	59			53		60	53	58					
Approval	c UL us - Recognized (OL)													
	c CSA us (OL)													
CE marking (see declaration of conformity)	To EU EMC Directive ⁶⁾													
Corrosion resistance class CRC ⁷⁾	2													

1) C=Normally closed/mid-position closed

2) U=Normally open/mid-position pressurised

3) E=Mid-position exhausted

4) H=2x 3/2-way valve in one housing with 1x normally closed and 1x normally open

5) Combined reset method

6) For information about the applicability of the component see the manufacturer's EC declaration of conformity at: www.festo.com/sp → Certificates.

If the component is subject to restrictions on usage in residential, office or commercial environments or small businesses, further measures to reduce the emitted interference may be necessary.

7) Corrosion resistance class 2 according to Festo standard 940 070

Components subject to moderate corrosion stress. Externally visible parts with primarily decorative surface requirements which are in direct contact with a normal industrial environment or media such as coolants or lubricating agents.

Valve terminals VTUG with multi-pin plug and fieldbus connection

FESTO

Technical data – Sub-base valves M5/M7

Operating and environmental conditions										
Valve function			T32-A ¹⁾	T32-M ³⁾	M32-R ²⁾	M52-R ²⁾	B52	M52-M ³⁾	P53	
Operating medium		Compressed air to ISO 8573-1:2010 [7:4:4]								
Operating pressure	Internal pilot air supply	[bar]	1.5 ... 8	2.5 ... 8	2.5 ... 8	2.5 ... 8	1.5 ... 8	3 ... 8	3 ... 8	
	External pilot air supply	[bar]	1.5 ... 10	-0.9 ... 10				-0.9 ... 8	-0.9 ... 10	
Pilot pressure ⁴⁾		[bar]	1.5 ... 8	2 ... 8	2.5 ... 8	2.5 ... 8	1.5 ... 8	3 ... 8	3 ... 8	
Ambient temperature		[°C]	-5 ... +60							
Temperature of medium		[°C]	-5 ... +60							

- 1) Pneumatic spring
- 2) Mixed, pneumatic/mechanical spring
- 3) Mechanical spring
- 4) Minimum pilot pressure 50% of operating pressure

Electrical data		
Electrical connection		Via E-box
Operating voltage	[V DC]	24 ±10%
Power consumption per valve solenoid	[W]	1/0.4 (after 25 ms)
Duty cycle ED	[%]	100
Max. switching frequency	[Hz]	3
Degree of protection to	Valve	IP67/IP65
EN 60529	Valve terminal	IP40, IP67/IP65

Safety characteristics		
Note on forced checking procedure		Min. 1/week
Max. positive test pulse with 0 signal	[µs]	1600
Max. negative test pulse with 1 signal	[µs]	3000
Resistance to shocks		Shock test with severity level 2 to FN 942017-5 and EN 60068-2-27
Vibration resistance		Transport application test with severity level 2 to FN 942017-4 and EN 60068-2-6

Information on materials	
Housing	Wrought aluminium alloy
Seals	HNBR, NBR
Note on materials	RoHS compliant

Valve switching times									
Valve function			T32-A ¹⁾	T32-M ³⁾	M32-R ²⁾	M52-R ²⁾	B52	M52-M ³⁾	P53
Switching time on	[ms]	8	10	9	9	–	12	12	
Switching time off	[ms]	20	20	17	21	–	30	38	
Changeover time	[ms]	–	–	–	–	9	–	16	

- 1) Pneumatic spring
- 2) Mixed, pneumatic/mechanical spring
- 3) Mechanical spring

Valve terminals VTUG with multi-pin plug and fieldbus connection

Technical data – Sub-base valves M5/M7

Dimensions Download CAD data → www.festo.com

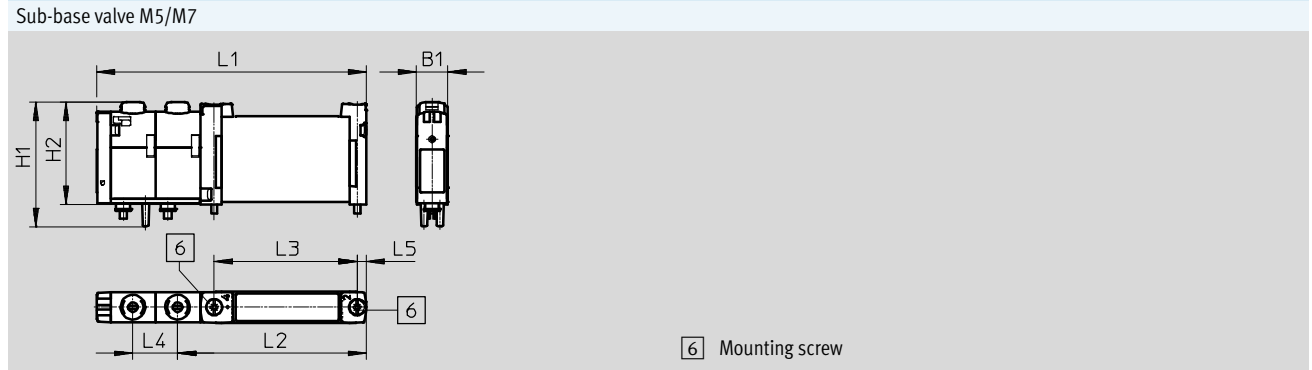

Type	B1	H1	H2	L1	L2	L3	L4	L5
VUVG-B10-...-F-1T1L	10.3	40.9	33.6	88.6	62	47	14.7	3

Ordering data		Description	Part No.	Type
Sub-base valve M5/M7				
	3/2-way valve			
	External pilot air supply	Normally closed, reset method: mechanical spring	8028231	VUVG-B10Z-M32C-RZT-F-1T1L
		Normally open, reset method: mechanical spring	8028232	VUVG-B10Z-M32U-RZT-F-1T1L
	2x3/2-way valve			
	External pilot air supply	Normally closed, reset method: pneumatic spring	573410	VUVG-B10-T32C-AZT-F-1T1L
		Normally open, reset method: pneumatic spring	573411	VUVG-B10-T32U-AZT-F-1T1L
		1x normally open, 1x normally closed, reset method: pneumatic spring	573412	VUVG-B10-T32H-AZT-F-1T1L
		Normally closed, reset method: mechanical spring	573413	VUVG-B10-T32C-MZT-F-1T1L
		Normally open, reset method: mechanical spring	573414	VUVG-B10-T32U-MZT-F-1T1L
		1x normally open, 1x normally closed, reset method: mechanical spring	573415	VUVG-B10-T32H-MZT-F-1T1L
	5/2-way valve, single solenoid			
	External pilot air supply	Reset method: mechanical spring	573417	VUVG-B10-M52-MZT-F-1T1L
		Reset method: pneumatic/mechanical spring	573416	VUVG-B10-M52-RZT-F-1T1L
	5/2-way valve, double solenoid			
External pilot air supply		573418	VUVG-B10-B52-ZT-F-1T1L	
5/3-way valve				
External pilot air supply	Mid-position closed	573419	VUVG-B10-P53C-ZT-F-1T1L	
	Mid-position pressurised	573421	VUVG-B10-P53U-ZT-F-1T1L	
	Mid-position exhausted	573420	VUVG-B10-P53E-ZT-F-1T1L	

Valve terminals VTUG with multi-pin plug and fieldbus connection

Order code – Sub-base valves G1/8

VUVG	-	B	14	-	
Valve design					
Sub-base valves B					
Width					
14 mm 14					
14 mm, 3/2-way valve (M32) 14Z					
Valve functions					
					M52
					B52
					P53C
					P53U
					P53E
					T32C
					T32H
					T32U
					M32C
					M32U



	Z	-	F	-	1	T1	L
Display							
L LED							
Electrical connection							
T1 Plug-in							
Nominal operating voltage							
1 24 V DC							
Pneumatic connection							
F Flange/sub-base							
Manual override							
H Non-detenting							
S Covered							
T Non-detenting, detenting							
Y Detenting, without accessories							
Pilot air							
Z External							
Reset method							
A Pneumatic spring with M52, M32 and T32							
M Mechanical spring with M52 and T32							
- With B52 and P53							

Valve terminals VTUG with multi-pin plug and fieldbus connection

FESTO

Technical data – Sub-base valves G1/8

Function
3/2C, 3/2U
2x3/2C, 2x3/2U, 2x3/2H
5/2-way, single solenoid
5/2-way, double solenoid
5/3C, 5/3U, 5/3E

-  - Width 14 mm
-  - Flow rate
350 ... 560 l/min
-  - Voltage
24 V DC



Circuit symbol → page 11

General technical data															
Valve function	T32-A			T32-M			M32-A		M52-A	B52	M52-M	P53			
Normal position	C ¹⁾	U ²⁾	H ⁴⁾	C ¹⁾	U ²⁾	H ⁴⁾	C ¹⁾	U ²⁾	-	-	-	C ¹⁾	U ²⁾	E ³⁾	
Stable position	Single solenoid									Double solenoid	Single solenoid				
Reset method: pneumatic spring	Yes			No			Yes		Yes	-	No	-			
Reset method: mechanical spring	No			Yes			No		No	-	Yes	-			
Vacuum operation at port 1	No			With external pilot air											
Design	Piston spool valve														
Sealing principle	Soft														
Actuation type	Electrical														
Type of control	Piloted														
Pilot air supply	External														
Exhaust function	With flow control														
Manual override	Choice of non-detenting, covered, non-detenting/detenting or detenting														
Type of mounting	On manifold rail														
Mounting position	Any														
Switching position display	LED														
Standard nominal flow rate G18	[l/min]	530			470			350		550	560	550	510		
Flow rate on manifold rail G18, front	[l/min]	490			440			320		500	510	500	470		
Flow rate on manifold rail G18, underneath	[l/min]	530			470			350		550	560	550	510		
Width	[mm]	14													
Port	1, 3, 5, 12/14, 82/84	On manifold rail													
	2, 4	On manifold rail													
Product weight	[g]	102			100			91		98	89	95			
Approval	c UL us - Recognized(OL)														
	c CSA us (OL)														
CE marking (see declaration of conformity)	To EU EMC Directive ⁵⁾														
Corrosion resistance class CRC ⁶⁾	2														

- 1) C=Normally closed/mid-position closed
- 2) U=Normally open/mid-position pressurised
- 3) E=Mid-position exhausted
- 4) H=2x 3/2-way valve in one housing with 1x normally closed and 1x normally open
- 5) For information about the applicability of the component see the manufacturer's EC declaration of conformity at: www.festo.com/sp → Certificates.
If the component is subject to restrictions on usage in residential, office or commercial environments or small businesses, further measures to reduce the emitted interference may be necessary.
- 6) Corrosion resistance class 2 according to Festo standard 940 070
Components subject to moderate corrosion stress. Externally visible parts with primarily decorative surface requirements which are in direct contact with a normal industrial environment or media such as coolants or lubricating agents.

Valve terminals VTUG with multi-pin plug and fieldbus connection

FESTO

Technical data – Sub-base valves G1/8

Operating and environmental conditions									
Valve function		T32-A ¹⁾	T32-M ²⁾	M32-A ¹⁾	M52-A ¹⁾	B52	M52-M ²⁾	P53	
Operating medium		Compressed air to ISO 8573-1:2010 [7:4:4]							
Operating pressure	Internal pilot air supply	[bar]	1.5 ... 8	3.5 ... 8	2.5 ... 8	2.5 ... 8	1.5 ... 8	3 ... 8	3 ... 8
	External pilot air supply	[bar]	1.5 ... 10	-0.9 ... 10				-0.9 ... 8	-0.9 ... 10
Pilot pressure ³⁾		[bar]	1.5 ... 8	2 ... 8	2.5 ... 8	2.5 ... 8	1.5 ... 8	3 ... 8	3 ... 8
Ambient temperature		[°C]	-5 ... +60						
Temperature of medium		[°C]	-5 ... +60						

1) Pneumatic spring

2) Mechanical spring

3) Minimum pilot pressure 50% of operating pressure

Electrical data		
Electrical connection		Via E-box
Operating voltage	[V DC]	24 ±10%
Power	[W]	1/0.4 (after 25 ms)
Duty cycle ED	[%]	100
Max. switching frequency	[Hz]	3
Degree of protection to EN 60529	Valve	IP67/IP65
	Valve terminal	IP40, IP67/IP65

Safety characteristics		
Note on forced checking procedure		Min. 1/week
Max. positive test pulse with 0 signal	[µs]	1600
Max. negative test pulse with 1 signal	[µs]	3000
Resistance to shocks		Shock test with severity level 2 to FN 942017-5 and EN 60068-2-27
Vibration resistance		Transport application test with severity level 2 to FN 942017-4 and EN 60068-2-6

Information on materials		
Housing	Wrought aluminium alloy	
Seals	HNBR, NBR	
Note on materials		RoHS compliant

Valve switching times								
Valve function		T32-A ¹⁾	T32-M ²⁾	M32-A ¹⁾	M52-A ¹⁾	B52	M52-M ²⁾	P53
Switching time on	[ms]	10	13	13	13	–	10	15
Switching time off	[ms]	29	21	20	26	–	38	42
Changeover time	[ms]	–	–	–	–	9	–	25

1) Pneumatic spring

2) Mechanical spring

Valve terminals VTUG with multi-pin plug and fieldbus connection

FESTO

Technical data – Sub-base valves G1/8

Dimensions Download CAD data → www.festo.com

Sub-base valve G1/8

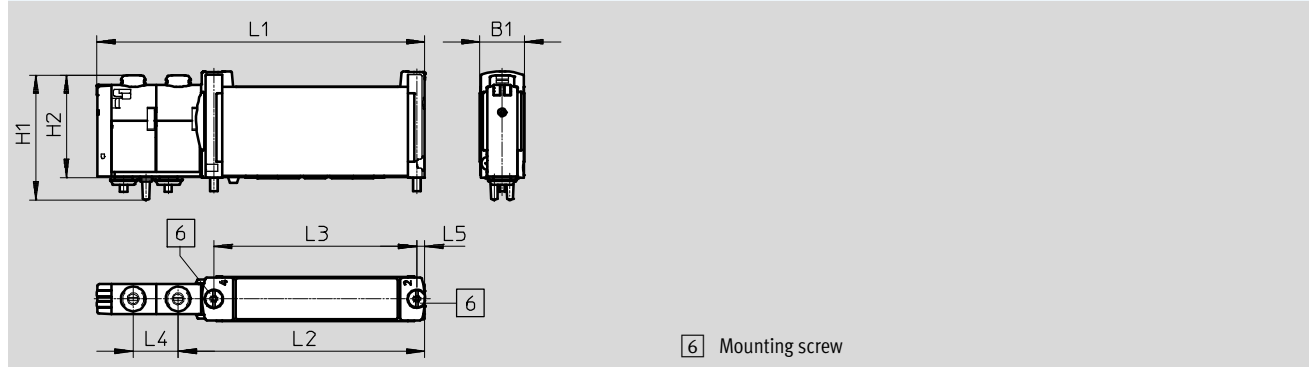

Type	B1	H1	H2	L1	L2	L3	L4	L5
VUVG-B14-...-F-1T1L	14.7	40.9	33.5	107.6	81	66.5	14.7	2.8

Ordering data				
		Description	Part No.	Type
Sub-base valve G1/8				
	3/2-way valve			
	External pilot air supply	Normally closed, reset method: pneumatic spring	8028235	VUVG-B14Z-M32C-AZT-F-1T1L
		Normally open, reset method: pneumatic spring	8028236	VUVG-B14Z-M32U-AZT-F-1T1L
	2x3/2-way valve			
	External pilot air supply	Normally closed, reset method: pneumatic spring	573476	VUVG-B14-T32C-AZT-F-1T1L
		Normally open, reset method: pneumatic spring	573477	VUVG-B14-T32U-AZT-F-1T1L
		1x normally open, 1x normally closed, reset method: pneumatic spring	573478	VUVG-B14-T32H-AZT-F-1T1L
		Normally closed, reset method: mechanical spring	573479	VUVG-B14-T32C-MZT-F-1T1L
		Normally open, reset method: mechanical spring	573480	VUVG-B14-T32U-MZT-F-1T1L
	1x normally open, 1x normally closed, reset method: mechanical spring	573481	VUVG-B14-T32H-MZT-F-1T1L	
	5/2-way valve, single solenoid			
	External pilot air supply	Reset method: pneumatic spring	573482	VUVG-B14-M52-AZT-F-1T1L
		Reset method: mechanical spring	573483	VUVG-B14-M52-MZT-F-1T1L
	5/2-way valve, double solenoid			
	External pilot air supply		573484	VUVG-B14-B52-ZT-F-1T1L
5/3-way valve				
External pilot air supply	Mid-position closed	573485	VUVG-B14-P53C-ZT-F-1T1L	
	Mid-position pressurised	573487	VUVG-B14-P53U-ZT-F-1T1L	
	Mid-position exhausted	573486	VUVG-B14-P53E-ZT-F-1T1L	

Valve terminals VTUG with multi-pin plug and fieldbus connection

Order code – Sub-base valves G1/4

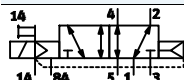
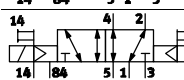
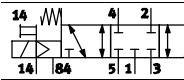
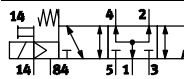
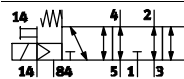
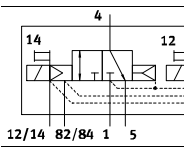
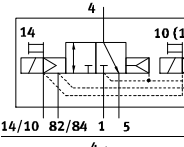
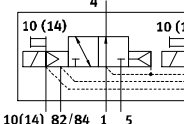
VUVG	-	B	18	-	
Valve design					
Sub-base valves B					
Width					
18 mm 18					
Valve functions					
				M52	
				B52	
				P53C	
				P53U	
				P53E	
				T32C	
				T32H	
				T32U	

Z	-	F	-	1	T1	L
Display						
L LED						
Electrical connection						
T1 Plug-in						
Nominal operating voltage						
1 24 V DC						
Pneumatic connection						
F Flange/sub-base						
Manual override						
H Non-detenting						
S Covered						
T Non-detenting, detenting						
Y Detenting, without accessories						
Pilot air						
Z External						
Reset method						
A Pneumatic spring with T32						
M Mechanical spring with M52 and T32						
R Pneumatic/mechanical spring with M52						
- With B52 and P53						



Valve terminals VTUG with multi-pin plug and fieldbus connection

Technical data – Sub-base valves G1/4

Function

2x3/2C, 2x3/2U, 2x3/2H
 5/2-way, single solenoid
 5/2-way, double solenoid
 5/3C, 5/3U, 5/3E

Circuit symbol → page 11

-  - Width 18 mm
-  - Flow rate
800 ... 1000 l/min
-  - Voltage
24 V DC

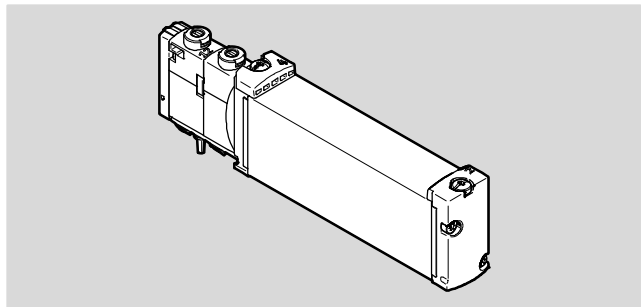

General technical data												
Valve function	T32-A			T32-M			M52-R	B52	M52-M	P53		
Normal position	C ¹⁾	U ²⁾	H ⁴⁾	C ¹⁾	U ²⁾	H ⁴⁾	-	-	-	C ¹⁾	U ²⁾	E ³⁾
Stable position	Single solenoid							Double solenoid	Single solenoid			
Reset method: pneumatic spring	Yes			No			Yes ⁵⁾	-	No	-		
Reset method: mechanical spring	No			Yes			Yes ⁵⁾	-	Yes	-		
Vacuum operation at port 1	No			With external pilot air								
Design	Piston spool valve											
Sealing principle	Soft											
Actuation type	Electrical											
Type of control	Piloted											
Pilot air supply	External											
Exhaust function	With flow control											
Manual override	Choice of non-detenting, covered, non-detenting/detenting or detenting											
Type of mounting	On manifold rail											
Mounting position	Any											
Switching position display	LED											
Flow rate on manifold rail G14, front	[l/min]	800	800	950	1000	950	900					
Width	[mm]	18										
Port	1, 3, 5, 12/14, 82/84	On manifold rail										
	2, 4	On manifold rail										
Product weight	[g]	145	147	138	145	138	140					
Approval	c UL us - Recognized (OL)											
	c CSA us (OL)											
CE marking (see declaration of conformity)	To EU EMC Directive ⁶⁾											
Corrosion resistance class CRC ⁷⁾	2											

1) C=Normally closed/mid-position closed
 2) U=Normally open/mid-position pressurised
 3) E=Mid-position exhausted
 4) H=2x 3/2-way valve in one housing with 1x normally closed and 1x normally open
 5) Combined reset method
 6) For information about the applicability of the component see the manufacturer's EC declaration of conformity at: www.festo.com/sp → Certificates.
 If the component is subject to restrictions on usage in residential, office or commercial environments or small businesses, further measures to reduce the emitted interference may be necessary.
 7) Corrosion resistance class 2 according to Festo standard 940 070
 Components subject to moderate corrosion stress. Externally visible parts with primarily decorative surface requirements which are in direct contact with a normal industrial environment or media such as coolants or lubricating agents.

Valve terminals VTUG with multi-pin plug and fieldbus connection

Technical data – Sub-base valves G1/4

Operating and environmental conditions								
Valve function			T32-A ¹⁾	T32-M ²⁾	M52-R ³⁾	B52	M52-M ²⁾	P53
Operating medium	Compressed air to ISO 8573-1:2010 [7:4:4]							
Pilot medium	Compressed air to ISO 8573-1:2010 [7:4:4]							
Note on operating/pilot medium	Lubricated operation possible (in which case lubricated operation will always be required)							
Operating pressure	Internal pilot air supply	[bar]	1.5 ... 8	2 ... 8	2.5 ... 8	1.5 ... 8	3 ... 8	3 ... 8
	External pilot air supply	[bar]	1.5 ... 10	-0.9 ... 10			-0.9 ... 8	-0.9 ... 10
Pilot pressure ⁴⁾		[bar]	1.5 ... 8	2 ... 8	2.5 ... 8	1.5 ... 8	3 ... 8	3 ... 8
Ambient temperature		[°C]	-5 ... +60					
Temperature of medium		[°C]	-5 ... +60					

- 1) Pneumatic spring
- 2) Mechanical spring
- 3) Mixed, pneumatic/mechanical spring
- 4) Minimum pilot pressure 50% of operating pressure

Electrical data		
Electrical connection	Via E-box	
Operating voltage	[V DC]	24 ±10%
Power	[W]	1
Duty cycle ED	[%]	100
Max. switching frequency	[Hz]	3
Degree of protection to EN 60529	Valve	IP67/IP65
	Valve terminal	IP40, IP67/IP65

Safety characteristics		
Note on forced checking procedure	Min. 1/week	
Max. positive test pulse with 0 signal	[µs]	1600
Max. negative test pulse with 1 signal	[µs]	3000
Resistance to shocks	Shock test with severity level 2 to FN 942017-5 and EN 60068-2-27	
Vibration resistance	Transport application test with severity level 2 to FN 942017-4 and EN 60068-2-6	

Information on materials	
Housing	Wrought aluminium alloy
Seals	HNBR, NBR
Note on materials	RoHS compliant

Valve switching times								
Valve function			T32-A ¹⁾	T32-M ²⁾	M52-R ³⁾	B52	M52-M ²⁾	P53
Switching time on	[ms]		15	25	20	–	13	20
Switching time off	[ms]		35	33	35	–	50	57
Changeover time	[ms]		–	–	–	15	–	31

- 1) Pneumatic spring
- 2) Mechanical spring
- 3) Mixed, pneumatic/mechanical spring

Valve terminals VTUG with multi-pin plug and fieldbus connection

Technical data – Sub-base valves G1/4

Dimensions

Download CAD data → www.festo.com

Sub-base valve G1/4

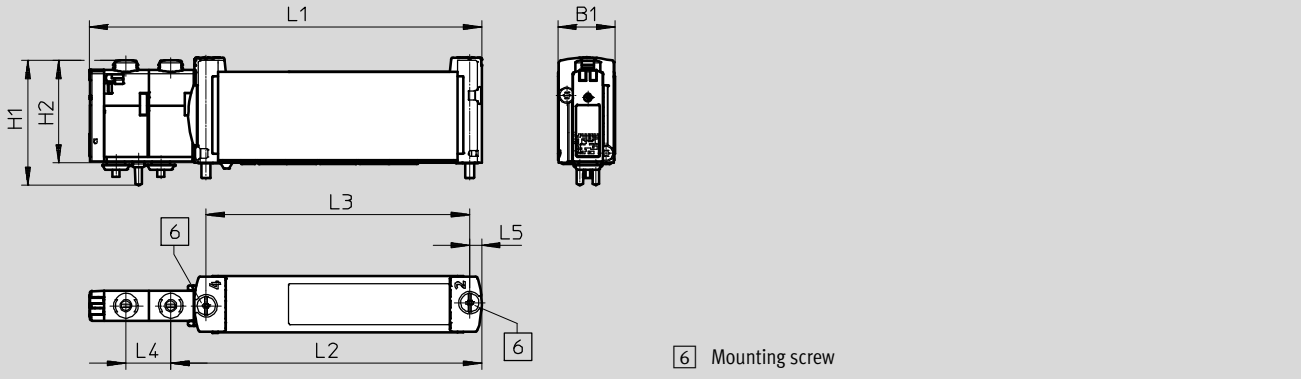

Type	B1	H1	H2	L1	L2	L3	L4	L5
VUVG-B18-...-F-1T1L	18.7	40.9	33.6	128.6	101.9	86.4	14.7	3.9

Ordering data

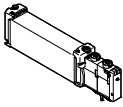
Description		Part No.	Type
Sub-base valve G1/4			
	2x3/2-way valve		
	External pilot air supply	Normally closed, reset method: pneumatic spring	8004885 VUVG-B18-T32C-AZT-F-1T1L
		Normally open, reset method: pneumatic spring	8004886 VUVG-B18-T32U-AZT-F-1T1L
		1x normally open, 1x normally closed, reset method: pneumatic spring	8004887 VUVG-B18-T32H-AZT-F-1T1L
		Normally closed, reset method: mechanical spring	8004888 VUVG-B18-T32C-MZT-F-1T1L
		Normally open, reset method: mechanical spring	8004889 VUVG-B18-T32U-MZT-F-1T1L
	1x normally open, 1x normally closed, reset method: mechanical spring	8004890 VUVG-B18-T32H-MZT-F-1T1L	
5/2-way valve, single solenoid			
External pilot air supply	Reset method: pneumatic/mechanical spring	8004891 VUVG-B18-M52-RZT-F-1T1L	
	Reset method: mechanical spring	8004892 VUVG-B18-M52-MZT-F-1T1L	
5/2-way valve, double solenoid			
External pilot air supply		8004893 VUVG-B18-B52-ZT-F-1T1L	
5/3-way valve			
External pilot air supply	Mid-position closed	8004894 VUVG-B18-P53C-ZT-F-1T1L	
	Mid-position pressurised	8004895 VUVG-B18-P53E-ZT-F-1T1L	
	Mid-position exhausted	8004896 VUVG-B14-P53E-ZT-F-1T1L	

Valve terminals VTUG with multi-pin plug and fieldbus connection

Order code – Manifold rail

VABM	-	L1	-						
Allocation									
Manifold rail		L1							
Size									
For valves with a width of 10 mm									10
For valves with a width of 14 mm									14
For valves with a width of 18 mm									18
Version									
Standard									-
High flow rate									H
Connection type									
Semi in-line									G
E-box									W
Connection direction									
At the side									-
Underneath									B
Pneumatic connection 1, 3 and 5									
G1/8 thread									G18
G1/4 thread									G14
G3/8 thread									G38

	-								
Outlet direction of electrical components									
	-								Top
Circuitry									
	-								None
	R								Holding current reduction with protective circuit
Electrical connection									
	-								None
	G								Preparation for electrical connection
Connection for valve function									
	-								All valve positions can be fitted with 2 valve coils
	M								Not all valve positions can be fitted with 2 valve coils
Valve positions									
4									4 valve positions
5									5 valve positions
6									6 valve positions
7									7 valve positions
8									8 valve positions
9									9 valve positions
10									10 valve positions
12									12 valve positions
16									16 valve positions
20									20 valve positions
24									24 valve positions

Valve terminals VTUG with multi-pin plug and fieldbus connection

Technical data – Manifold rail VABM

General technical data		Size 10	Size 14	Size 18
Manifold rail				
Type code	VABM			
Grid dimension	[mm]	10.5	16	19
Mounting position	Any			
Connection type	Semi in-line/sub-base			
Max. number of valve positions	24			
Port	12/14	M5	M5	G $\frac{1}{8}$
	82/84	M5	M5	G $\frac{1}{8}$
	2, 4	M5 or M7	G $\frac{1}{8}$	G $\frac{1}{4}$
	1, 3, 5	G $\frac{1}{8}$	G $\frac{1}{4}$	G $\frac{3}{8}$
Storage temperature	[°C]	-20 ... 60		
Approval	c UL us - Recognized (OL)			
	c CSA us (OL)			
CE marking (see declaration of conformity)	To EU EMC Directive ¹⁾			
Corrosion resistance class CRC ²⁾	2			

1) For information about the applicability of the component see the manufacturer's EC declaration of conformity at: www.festo.com/sp → Certificates.

If the component is subject to restrictions on usage in residential, office or commercial environments or small businesses, further measures to reduce the emitted interference may be necessary.

2) Corrosion resistance class 2 according to Festo standard 940 070

Components subject to moderate corrosion stress. Externally visible parts with primarily decorative surface requirements which are in direct contact with a normal industrial environment or media such as coolants or lubricating agents.

Weight [g]											
Valve positions	4	5	6	7	8	9	10	12	16	20	24
VABM-L1-10G-G18-...	329	363	397	431	465	499	533	601	737	873	1009
VABM-L1-10HW-G18-...	388	426	464	502	540	578	616	692	844	996	1148
VABM-L1-14G-G14-...	879	990	1101	1212	1323	1434	1545	1767	2211	2655	3099
VABM-L1-14W-G14-...	839	940	1041	1142	1243	1344	1445	1647	2051	2455	2859
VABM-L1-18G-G38-...	1461	1661	1861	2061	2261	2461	2661	3061	3861	4661	5461
VABM-L1-18W-G38-...	1369	1546	1723	1900	2077	2254	2431	2785	3493	4201	4909

Materials	
Manifold rail	Wrought aluminium alloy
Note on materials	RoHS compliant

Valve terminals VTUG with multi-pin plug and fieldbus connection

Technical data – Manifold rail VABM

Dimensions – Example of a valve terminal with I-Port interface

Download CAD data → www.festo.com

Outlet on top

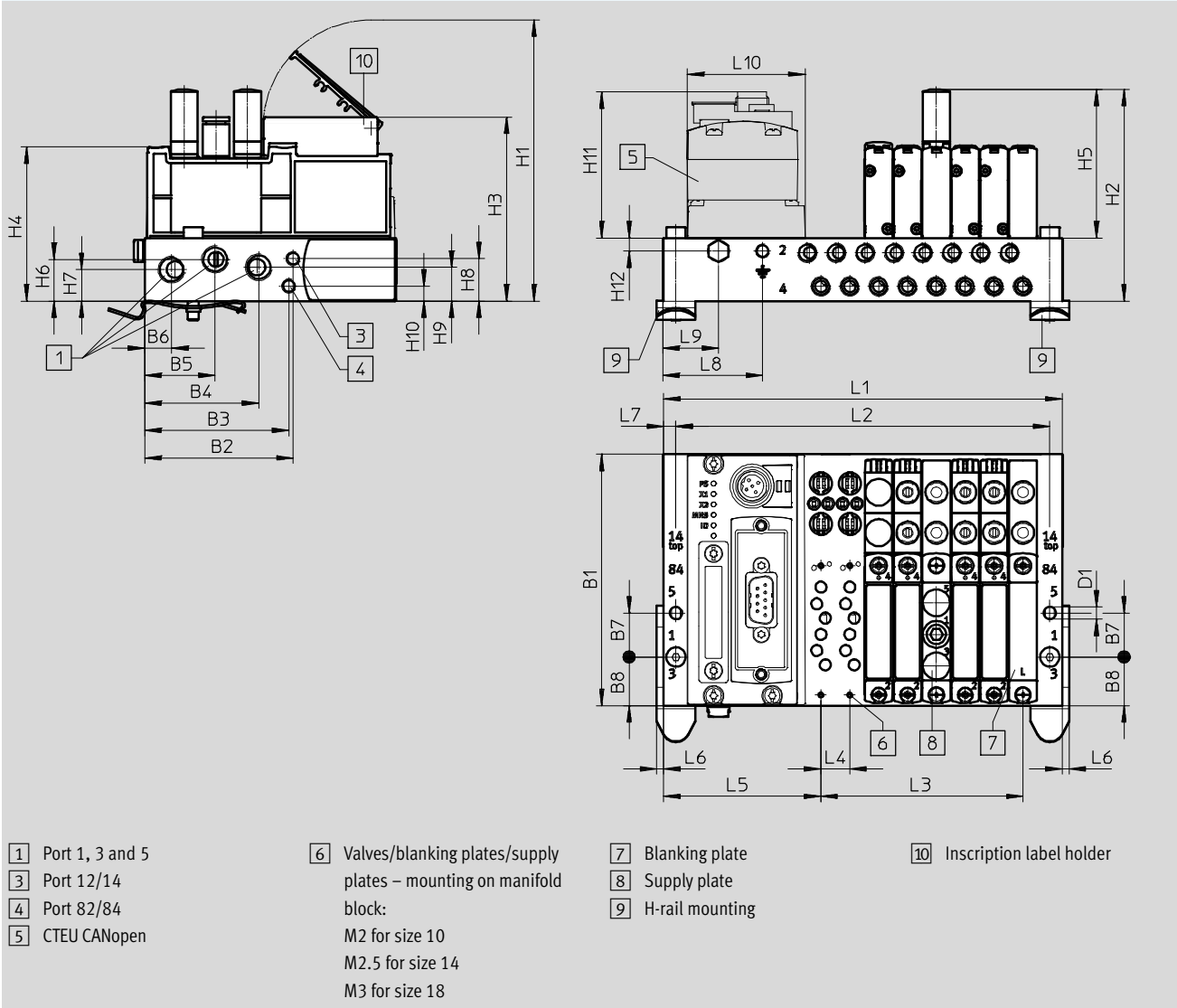

Type	No. of valve positions	Size 10																
		B1	B2	B3	B4	B5	B6	B7	B8	D1 Ø	H1	H2	H3	H4	H5	H6	H7	H8
VABM	4-24	91.5	54	52.4	41.5	25.6	9.8	16	17.7	4.5	102.3	77.1	67	56.1	54.1	15.2	11.5	15.5

Type	No. of valve positions	Size 10										
		H9	H10	H11	H12	L4	L5	L6	L7	L8	L9	L10
VABM	4-24	12.4	5.5	54.8	4.8	10.5	57.3	2.5	4.5	36	20	42.5

Type	No. of valve positions	Size 14																
		B1	B2	B3	B4	B5	B6	B7	B8	D1 Ø	H1	H2	H3	H4	H5	H6	H7	H8
VABM	4-24	110	70	59.3	56.5	36.5	16	20	26.5	4.5	113.1	95.1	77.7	68.6	61.3	18.7	15.7	28.7

Valve terminals VTUG with multi-pin plug and fieldbus connection

Technical data – Manifold rail VABM

Type	No. of valve positions	Size 14										
		H9	H10	H11	H12	L4	L5	L6	L7	L8	L9	L10
VABM	4-24	13.2	23.7	54.8	5.1	16	60.6	2	5	10	25.5	42.5

Type	No. of valve positions	Size 18																
		B1	B2	B3	B4	B5	B6	B7	B8	D1 Ø	H1	H2	H3	H4	H5	H6	H7	H8
VABM	4-24	131	90.5	77.3	72.3	47.5	21.5	26	34	5.5	121.5	95.2	–	77.4	52.7	23.6	18.7	35.1

Type	No. of valve positions	Size 18										
		H9	H10	H11	H12	L4	L5	L6	L7	L8	L9	L10
VABM	4-24	14.5	27	54.8	13.8	19	63.5	2	5	10	27	42.5

Type	No. of valve positions	Size 10			Size 14			Size 18		
		L1	L2	L3	L1	L2	L3	L1	L2	L3
VABM	4	103	94	31.5	128	118	48	139.5	129.5	57
	5	113.5	104.5	42	144	134	64	158.5	148.5	76
	6	124	115	52.5	160	150	80	177.5	167.5	95
	7	134.5	125.5	63	176	166	96	196.5	186.5	114
	8	145	136	73.5	192	182	112	215.5	205.5	133
	9	155.5	146.5	84	208	198	128	234.5	224.5	152
	10	166	157	94.5	224	214	144	253.5	243.5	171
	12	187	178	115.5	256	246	176	291.5	281.5	209
	16	229	220	157.5	320	310	240	367.5	357.5	285
	20	271	262	199.5	384	374	304	443.5	433.5	361
24	313	304	241.5	448	438	368	519.5	509.5	437	

Valve terminals VTUG with multi-pin plug and fieldbus connection

Technical data – Manifold rail VABM

Dimensions – Example of a valve terminal with I-Port interface

Download CAD data → www.festo.com

Outlet on the side

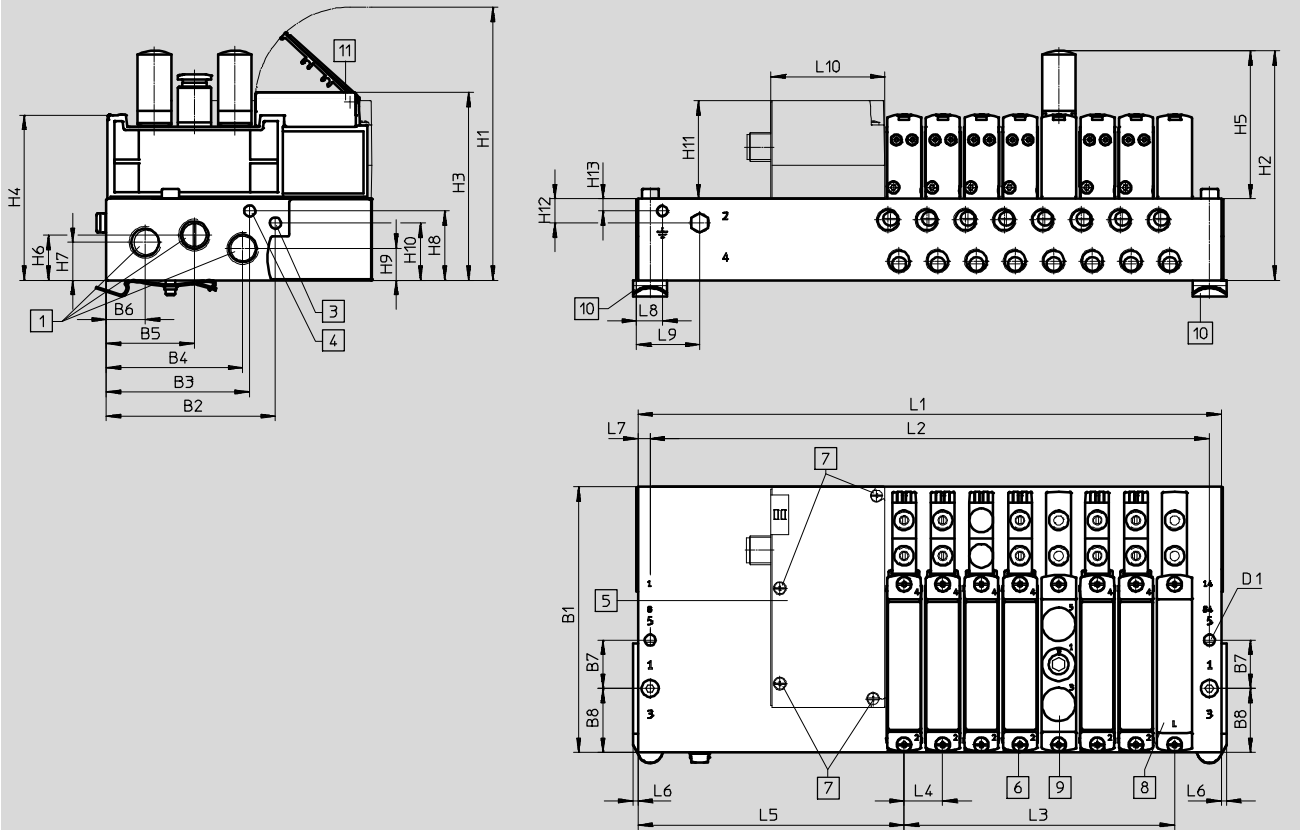

- | | | | |
|----------------------------------------------------------|-------------------------------------------------------------------------------------------------------------------------------------|----------------------------------------------------------------|------------------------------------|
| 1 Port 1, 3 and 5 | 6 Valves/blanking plates/supply plates – mounting on manifold block:
M2 for size 10
M2.5 for size 14
M3 for size 18 | 7 Electrical interface – mounting on manifold block: M3 | 9 Supply plate |
| 3 Port 12/14 | | 8 Blanking plate | 10 H-rail mounting |
| 4 Port 82/84 | | | 11 Inscription label holder |
| 5 Electrical connection, I-Port interface/IO-Link | | | |

Type	No. of valve positions	Size 10																
		B1	B2	B3	B4	B5	B6	B7	B8	D1 Ø	H1	H2	H3	H4	H5	H6	H7	H8
VABM	4-24	91.5	54	52.4	41.5	25.6	9.8	16	17.7	4.5	102.3	77.1	67	56.1	54.1	15.2	11.5	15.5

Type	No. of valve positions	Size 10												
		H9	H10	H11	H12	H13	L4	L5	L6	L7	L8	L9	L10	
VABM	4-24	12.4	5.5	40.8	10.1	5.1	10.5	106.8	2.5	4.5	36	75	47.1	

Type	No. of valve positions	Size 14																
		B1	B2	B3	B4	B5	B6	B7	B8	D1 Ø	H1	H2	H3	H4	H5	H6	H7	H8
VABM	4-24	110	70	59.3	56.5	36.5	16	20	26.5	4.5	113.1	95.1	77.7	68.6	61.3	18.7	15.7	28.7

Type	No. of valve positions	Size 14												
		H9	H10	H11	H12	H13	L4	L5	L6	L7	L8	L9	L10	
VABM	4-24	13.2	23.7	40.8	10.1	5.1	16	110.1	2	5	10	75	47.1	

Valve terminals VTUG with multi-pin plug and fieldbus connection

Technical data – Manifold rail VABM

Type	No. of valve positions	Size 18																
		B1	B2	B3	B4	B5	B6	B7	B8	D1 Ø	H1	H2	H3	H4	H5	H6	H7	H8
VABM	4-24	131	90.5	77.3	72.3	47.5	21.5	26	34	5.5	121.5	95.2	–	77.4	52.7	23.6	18.7	35.1

Type	No. of valve positions	Size 18											
		H9	H10	H11	H12	H13	L4	L5	L6	L7	L8	L9	L10
VABM	4-24	14.5	27	40.8	13.8	10	19	105	2	5	10	27	47.1

Type	No. of valve positions	Size 10			Size 14			Size 18		
		L1	L2	L3	L1	L2	L3	L1	L2	L3
VABM	4	152.5	143.5	31.5	177.5	167.5	48	181	171	57
	5	163	154	42	193.5	183.5	64	200	190	76
	6	173.5	164.5	52.5	209.5	199.5	80	219	209	95
	7	184	175	63	225.5	215.5	96	238	228	114
	8	194.5	185.5	73.5	241.5	231.5	112	257	247	133
	9	205	196	84	257.5	247.5	128	276	266	152
	10	215.5	206.5	94.5	273.5	263.5	144	295	285	171
	12	236.5	227.5	115.5	305.5	295.5	176	333	323	209
	16	278.5	269.5	157.5	369.5	359.5	240	409	399	285
	20	321	311.5	199.5	433.5	423.5	304	485	475	361
24	362.5	353.5	241.5	497.5	487.5	368	561	551	437	



Note

The dimensions for size 10 are the same as the dimensions for the manifold rail with interlock.

Valve terminals VTUG with multi-pin plug and fieldbus connection

Dimensions – Example of a valve terminal

Dimensions – Front manifold rail

Download CAD data → www.festo.com

Size 10, I-Port interface, outlet on top

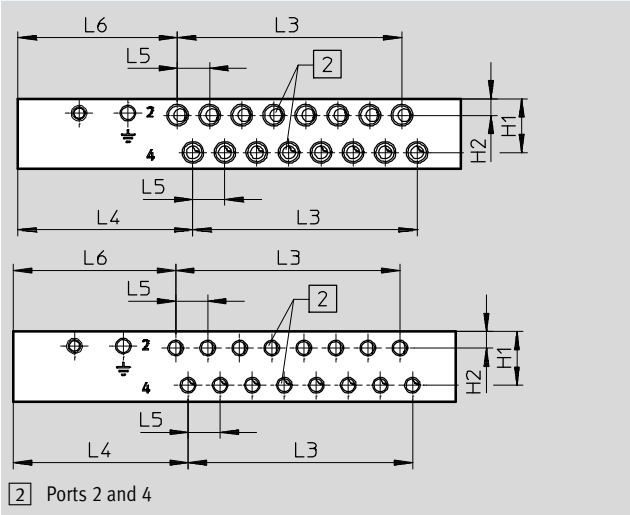

Size 14, I-Port interface, outlet on top

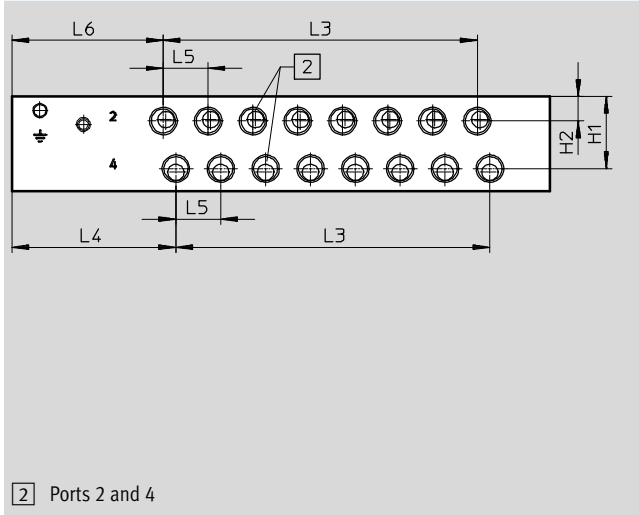

Size 18, I-Port interface, outlet on top

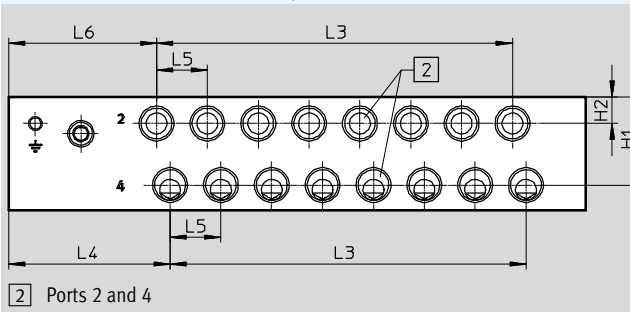

Size 10, 14, 18, I-Port interface, outlet on the side

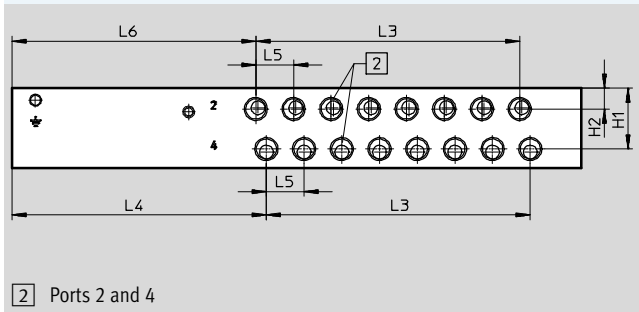

Size	Port 2 and 4	Manifold rail with I-Port interface, outlet on top				
		H1	H2	L4	L5	L6
10	M7 thread	17.6	5.4	57.3	10.5	52.3
	M5 thread					53.2
14	G1/8 thread	25.8	8.8	58.5	16	54
18	G1/4 thread	33	10	60.3	19	55.3

Size	Port 2 and 4	Manifold rail with I-Port interface, outlet on the side				
		H1	H2	L4	L5	L6
10	M7 thread	17.6	5.4	106.8	10.5	101.8
	M5 thread					102.7
14	G1/8 thread	25.8	8.8	108	16	103.5
18	G1/4 thread	33	10	101.8	19	96.8

Valve terminals VTUG with multi-pin plug and fieldbus connection

Dimensions – Example of a valve terminal

Type	Number of valve positions	Size 10	Size 14	Size 18
		L3	L3	L3
VABM	4	31.5	48	57
	5	42	64	76
	6	52.5	80	95
	7	63	96	114
	8	73.5	112	133
	9	84	128	152
	10	94.5	144	171
	12	115.5	176	209
	16	157.5	240	285
	20	199.5	304	361
	24	241.5	368	437

Valve terminals VTUG with multi-pin plug and fieldbus connection

Dimensions – Example of control cabinet installation

Dimensions – Manifold rail, outlet underneath

Download CAD data → www.festo.com

Control cabinet installation

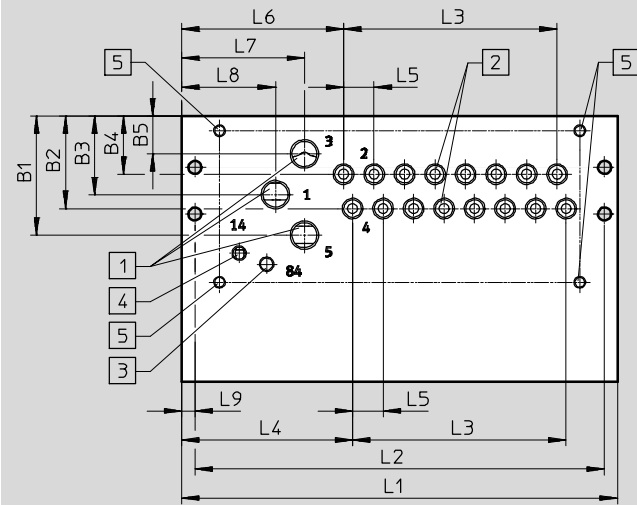

 Note
Dimensions of the manifold rail with I-Port interface, outlet on the side for control cabinet installation (→164)

- 1 Port 1, 3 and 5
- 2 Ports 2 and 4
- 3 Port 82/84
- 4 Port 12/14
- 5 Mounting holes, outlet direction underneath: M4x8 for size 10 and 14, M5x8 for size 18

Type	Manifold rail with I-Port interface, outlet underneath, size 10										
	B1	B2	B3	B4	B5	L4	L5	L6	L7	L8	L9
VABM	41	31.8	27	20	13	58.8	10.5	55.7	42.3	32.3	4.5

Type	Manifold rail with I-Port interface, outlet underneath, size 14										
	B1	B2	B3	B4	B5	L4	L5	L6	L7	L8	L9
VABM	53.5	45.1	35.2	27.8	17	58.5	16	58.5	43	33	5

Type	Manifold rail with I-Port interface, outlet underneath, size 18										
	B1	B2	B3	B4	B5	L4	L5	L6	L7	L8	L9
VABM	75	59.5	48.5	35.7	22	60.3	19	60.3	40	40	5

Type	No. of valve positions	Size 10			Size 14			Size 18		
		L1 +5	L2 +5	L3	L1	L2	L3	L1	L2	L3
VABM	4	103	94	31.5	128	118	48	139.5	129.5	57
	5	113.5	104.5	42	144	134	64	158.5	148.5	76
	6	124	115	52.5	160	150	80	177.5	167.5	95
	7	134.5	125.5	63	176	166	96	196.5	186.5	114
	8	145	136	73.5	192	182	112	215.5	205.5	133
	9	155.5	146.5	84	208	198	128	234.5	224.5	152
	10	166	157	94.5	224	214	144	253.5	243.5	171
	12	187	178	115.5	256	246	176	291.5	281.5	209
	16	229	220	157.5	320	310	240	367.5	357.5	285
	20	271	262	199.5	384	374	304	443.5	433.5	361
24	313	304	241.5	448	438	368	519.5	509.5	437	

Valve terminals VTUG with multi-pin plug and fieldbus connection

Dimensions

Type	Manifold rail with I-Port interface, outlet on the side, size 10										
	B1	B2	B3	B4	B5	L4	L5	L6	L7	L8	L9
VABM	41	31.8	27	20	13	108.3	10.5	105.2	91.8	81.8	4.5

Type	Manifold rail with I-Port interface, outlet on the side, size 14										
	B1	B2	B3	B4	B5	L4	L5	L6	L7	L8	L9
VABM	53.5	45.1	35.2	27.8	17	108	16	108	92.5	82.5	5

Type	Manifold rail with I-Port interface, outlet on the side, size 18										
	B1	B2	B3	B4	B5	L4	L5	L6	L7	L8	L9
VABM	75	59.5	48.5	35.7	22	101.8	19	101.8	81.5	81.5	5

Type	No. of valve positions	Manifold rail with I-Port interface, outlet on the side, size 10			Manifold rail with I-Port interface, outlet on the side, size 14			Manifold rail with I-Port interface, outlet on the side, size 18		
		L1	L2	L3	L1	L2	L3	L1	L2	L3
		+5	+5							
VABM	4	152.5	143.5	31.5	177.5	167.5	48	181	171	57
	5	163	154	42	193.5	183.5	64	200	190	76
	6	173.5	164.5	52.5	209.5	199.5	80	219	209	95
	7	184	175	63	225.5	215.5	96	238	228	114
	8	194.5	185.5	73.5	241.5	231.5	112	257	247	133
	9	205	196	84	257.5	247.5	128	276	266	152
	10	215.5	206.5	94.5	273.5	263.5	144	295	285	171
	12	236.5	227.5	115.5	305.5	295.5	176	333	323	209
	16	278.5	269.5	157.5	369.5	359.5	240	409	399	285
	20	320.5	311.5	199.5	433.5	423.5	304	485	475	361
24	362.5	353.5	241.5	497.5	487.5	368	561	551	437	

Dimensions – Recess for control cabinet installation, outlet underneath, size 10

Up to 8 valves

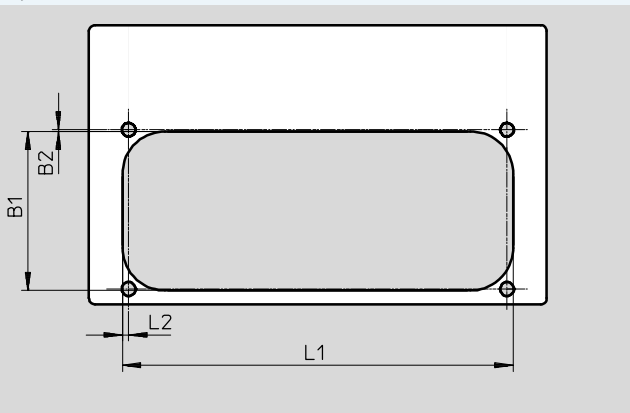

9 or more valves

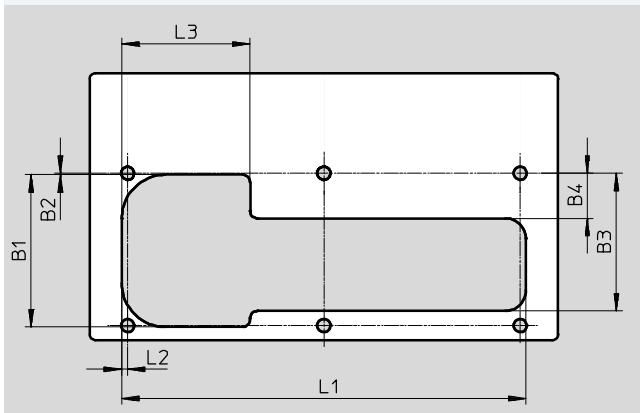

Type	B1	B2	L1	L2
VABM-L1-10...G18-4	52.7	0.5	86	2
VABM-L1-10...G18-5			96.5	
VABM-L1-10...G18-6			107	
VABM-L1-10...G18-7			117.5	
VABM-L1-10...G18-8			128	

Type	B1	B2	B3	B4	L1	L2	L3
VABM-L1-10...G18-9	52.7	0.5	47.2	15.4	138.5	2	44
VABM-L1-10...G18-10					149		
VABM-L1-10...G18-12					170		
VABM-L1-10...G18-16					212		
VABM-L1-10...G18-20					254		
VABM-L1-10...G18-24					296		

Valve terminals VTUG with multi-pin plug and fieldbus connection

Dimensions

Dimensions – Recess for control cabinet installation, outlet underneath, size 14

Up to 7 valves

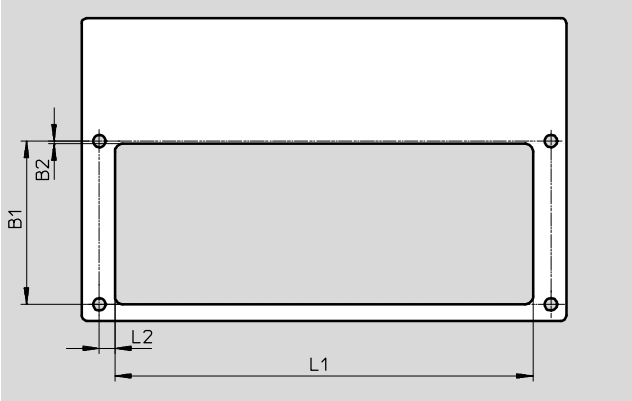

8 or more valves

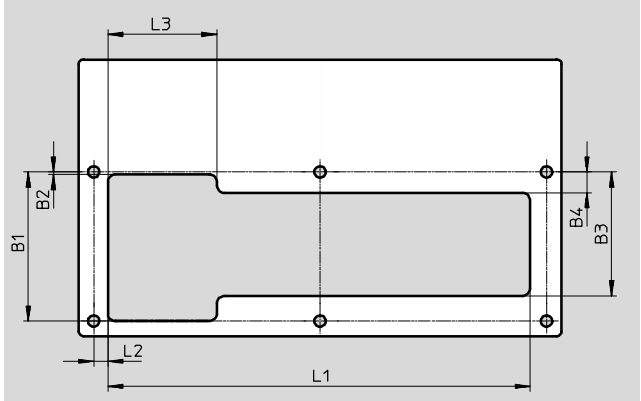

Type	B1	B2	L1	L2
VABM-L1-14...G14-4	59.3	1	103.9	5.6
VABM-L1-14...G14-5			119.9	
VABM-L1-14...G14-6			135.9	
VABM-L1-14...G14-7			151.9	

Type	B1	B2	B3	B4	L1	L2	L3
VABM-L1-14...G14-8	59.3	1	49.3	8.3	167.9	56	43.4
VABM-L1-14...G14-9					183.9		
VABM-L1-14...G14-10					199.9		
VABM-L1-14...G14-12					231.9		
VABM-L1-14...G14-16					295.9		
VABM-L1-14...G14-20					359.9		
VABM-L1-14...G14-24					423.9		

Dimensions – Recess for control cabinet installation, outlet underneath, size 18

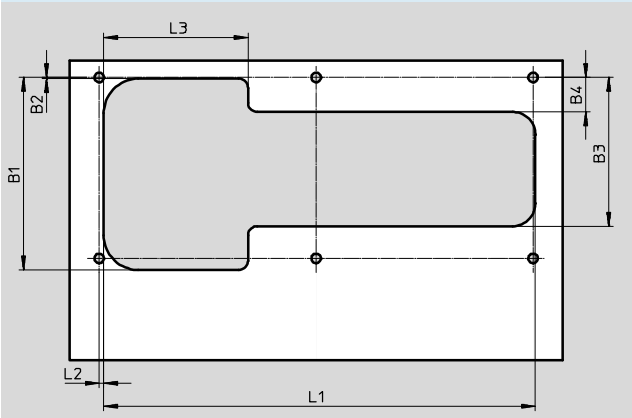

Type	B1	B2	B3	B4	L1	L2	L3
VABM-L1-18...G38-4	83.5	0.5	65	15	112.5	2	63
VABM-L1-18...G38-5					131.5		
VABM-L1-18...G38-6					150.5		
VABM-L1-18...G38-7					169.5		
VABM-L1-18...G38-8					188.5		
VABM-L1-18...G38-9					207.5		
VABM-L1-18...G38-10					226.5		
VABM-L1-18...G38-12					264.5		
VABM-L1-18...G38-16					340.5		
VABM-L1-18...G38-20					416.5		
VABM-L1-18...G38-24	492.5						

Valve terminals VTUG with multi-pin plug and fieldbus connection

Dimensions

Dimensions – Mounting holes, size 10

Download CAD data → www.festo.com

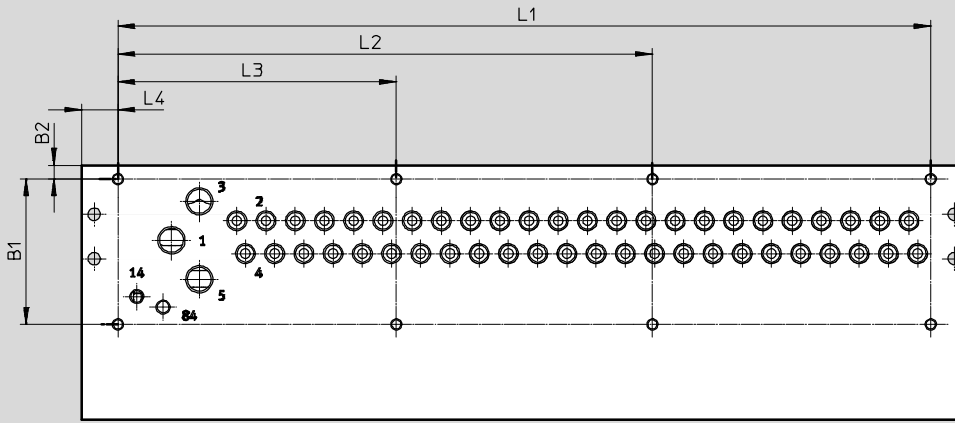

Type		B1	B2	L1	L2	L3	L4	I-Port interface, outlet on the side L4
VABM-L1-10...-G18-4	Up to 8 valves	52.2	5	82	–	–	13	62.5
VABM-L1-10...-G18-5				92.5	–	–		
VABM-L1-10...-G18-6				103	–	–		
VABM-L1-10...-G18-7				113.5	–	–		
VABM-L1-10...-G18-8				124	–	–		
VABM-L1-10...-G18-9	Up to 20 valves	52.2	5	134.5	–	67.25	13	62.5
VABM-L1-10...-G18-10				145	–	72.5		
VABM-L1-10...-G18-12				166	–	83		
VABM-L1-10...-G18-16				208	–	104		
VABM-L1-10...-G18-20				250	–	125		
VABM-L1-10...-G18-24	24 valves	52.2	5	292	192	100	13	62.5

Valve terminals VTUG with multi-pin plug and fieldbus connection

Dimensions

Dimensions – Mounting holes, size 14

Download CAD data → www.festo.com

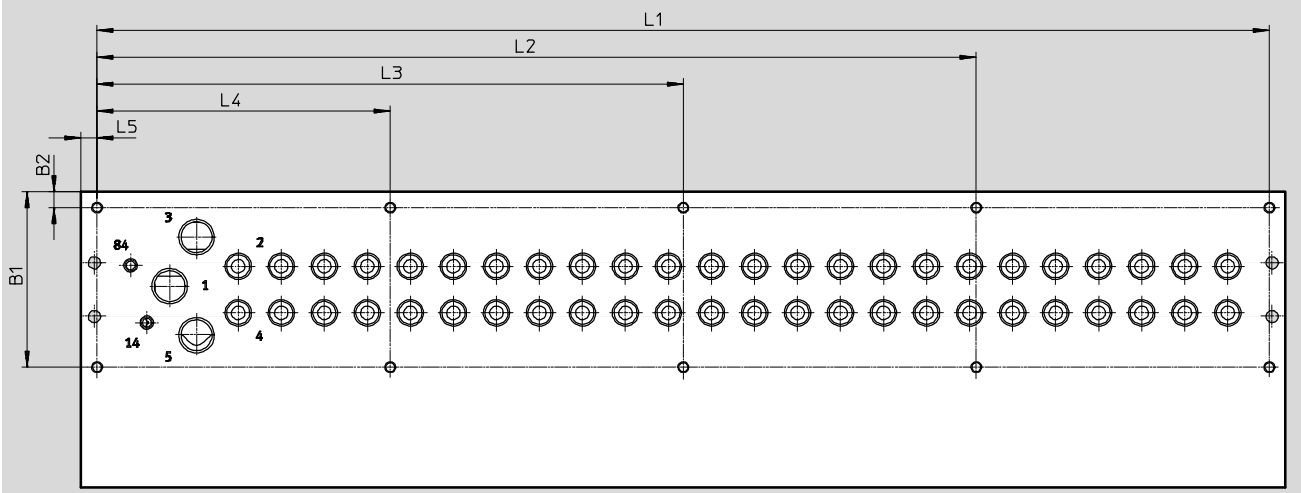

Type		B1	B2	L1	L2	L3	L4	L5	I-Port interface, outlet on the side L4
VABM-L1-14...-G14-4	Up to 8 valves	59.3	6	116	–	–	–	6	55.5
VABM-L1-14...-G14-5				132	–	–	–		
VABM-L1-14...-G14-6				148	–	–	–		
VABM-L1-14...-G14-7				164	–	–	–		
VABM-L1-14...-G14-8	8 to 10 valves	59.3	6	180	–	–	90	6	55.5
VABM-L1-14...-G14-9				196	–	–	98		
VABM-L1-14...-G14-10				212	–	–	106		
VABM-L1-14...-G14-12	12 valves and	59.3	6	244	–	162	82	6	55.5
VABM-L1-14...-G14-16	16 valves			308	–	204	104		
VABM-L1-14...-G14-20	20 valves and	59.3	6	372	279	186	93	6	55.5
VABM-L1-14...-G14-24	24 valves			436	327	218	109		

Valve terminals VTUG with multi-pin plug and fieldbus connection

Dimensions

Dimensions – Mounting holes, size 18

Download CAD data → www.festo.com

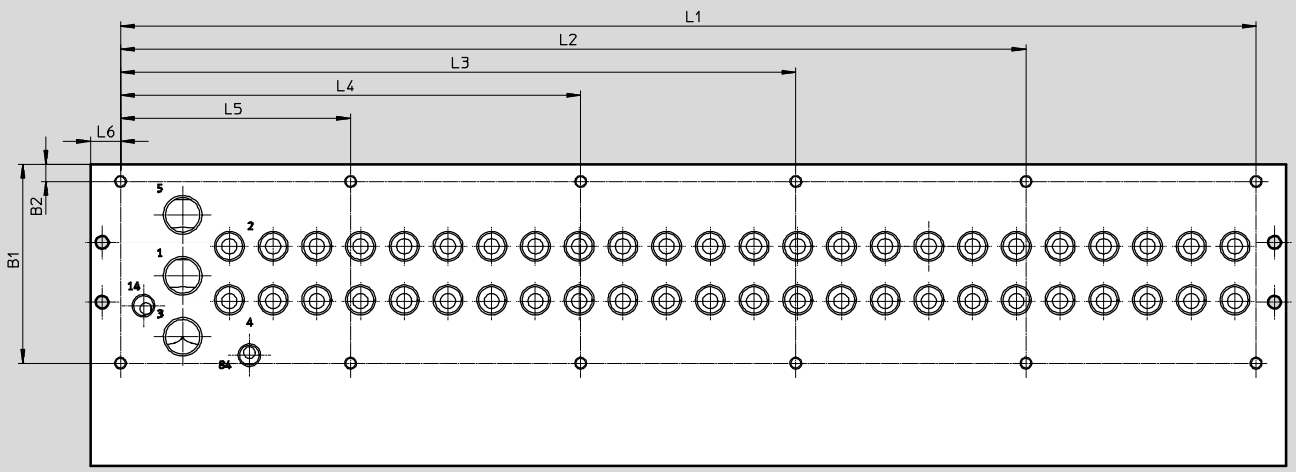

Type		B1	B2	L1	L2	L3	L4	L5	I-Port interface, outlet on the side L4
VABM-L1-18...-G38-4	4 valves and	86.5	7.5	113.5	–	–	–	–	54.5
VABM-L1-18...-G38-5	5 valves			132.5	–	–	–	–	
VABM-L1-18...-G38-6	6 to 10 valves	86.5	7.5	151.5	–	–	–	75.8	54.5
VABM-L1-18...-G38-7				170.5	–	–	–	85.3	
VABM-L1-18...-G38-8				189.5	–	–	–	94.8	
VABM-L1-18...-G38-9				208.5	–	–	–	104.3	
VABM-L1-18...-G38-10				227.5	–	–	–	113.8	
VABM-L1-18...-G38-12	12 valves	86.5	7.5	265.5	–	–	165.5	100	54.5
VABM-L1-18...-G38-16	16 valves and	86.5	7.5	341.5	–	–	170.8	100	54.5
VABM-L1-18...-G38-20				20 valves	417.5	–	317.5	208.8	
VABM-L1-18...-G38-24	24 valves	86.5	7.5	493.5	393.5	293.5	200	100	54.5



New

Size 18

FESTO

Valve terminals VTUG with multi-pin plug and fieldbus connection

Ordering data

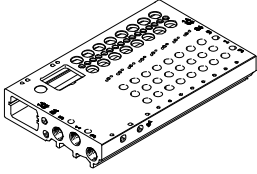
Ordering data		Description	Part No.	Type
Manifold rail for semi in-line valve				
	For valve size M5/M7			
	Port 2, 4 on the valve	4 valve positions	573423	VABM-L1-10G-G18-4-GR
		5 valve positions	573424	VABM-L1-10G-G18-5-GR
		6 valve positions	573425	VABM-L1-10G-G18-6-GR
		7 valve positions	573426	VABM-L1-10G-G18-7-GR
		8 valve positions	573427	VABM-L1-10G-G18-8-GR
		9 valve positions	573428	VABM-L1-10G-G18-9-GR
		10 valve positions	573429	VABM-L1-10G-G18-10-GR
		12 valve positions	573430	VABM-L1-10G-G18-12-GR
		16 valve positions	573431	VABM-L1-10G-G18-16-GR
		20 valve positions	573432	VABM-L1-10G-G18-20-GR
		24 valve positions	573433	VABM-L1-10G-G18-24-GR
		8 double solenoid + 8 single solenoid valves	573927	VABM-L1-10G-G18-16-M-GR
		4 double solenoid + 16 single solenoid valves	573928	VABM-L1-10G-G18-20-M-GR
		24 single solenoid valves	573929	VABM-L1-10G-G18-24-M-GR
	For valve size G ¹ / ₈			
	Port 2, 4 on the valve	4 valve positions	573489	VABM-L1-14G-G14-4-GR
		5 valve positions	573490	VABM-L1-14G-G14-5-GR
		6 valve positions	573491	VABM-L1-14G-G14-6-GR
		7 valve positions	573492	VABM-L1-14G-G14-7-GR
		8 valve positions	573493	VABM-L1-14G-G14-8-GR
		9 valve positions	573494	VABM-L1-14G-G14-9-GR
		10 valve positions	573495	VABM-L1-14G-G14-10-GR
		12 valve positions	573496	VABM-L1-14G-G14-12-GR
		16 valve positions	573497	VABM-L1-14G-G14-16-GR
		20 valve positions	573498	VABM-L1-14G-G14-20-GR
		24 valve positions	573499	VABM-L1-14G-G14-24-GR
		8 double solenoid + 8 single solenoid valves	573933	VABM-L1-14G-G14-16-M-GR
		4 double solenoid + 16 single solenoid valves	573934	VABM-L1-14G-G14-20-M-GR
		24 single solenoid valves	573935	VABM-L1-14G-G14-24-M-GR
	For valve size G ¹ / ₄			
	Port 2, 4 on the valve	4 valve positions	8004899	VABM-L1-18G-G38-4-GR
		5 valve positions	8004900	VABM-L1-18G-G38-5-GR
		6 valve positions	8004901	VABM-L1-18G-G38-6-GR
		7 valve positions	8004902	VABM-L1-18G-G38-7-GR
		8 valve positions	8004903	VABM-L1-18G-G38-8-GR
		9 valve positions	8004904	VABM-L1-18G-G38-9-GR
		10 valve positions	8004905	VABM-L1-18G-G38-10-GR
		12 valve positions	8004906	VABM-L1-18G-G38-12-GR
		16 valve positions	8004907	VABM-L1-18G-G38-16-GR
		20 valve positions	8004908	VABM-L1-18G-G38-20-GR
		24 valve positions	8004909	VABM-L1-18G-G38-24-GR
8 double solenoid + 8 single solenoid valves		8004910	VABM-L1-18G-G38-16-M-GR	
4 double solenoid + 16 single solenoid valves		8004911	VABM-L1-18G-G38-20-M-GR	
24 single solenoid valves		8004912	VABM-L1-18G-G38-24-M-GR	

Valve terminals VTUG with multi-pin plug and fieldbus connection

Ordering data

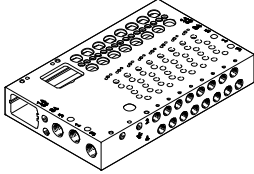
Ordering data		Description	Part No.	Type
Manifold rail for sub-base valve				
	For valve size M5/M7			
	Port 2, 4 at front	4 valve positions	573434	VABM-L1-10HW-G18-4-GR
		5 valve positions	573435	VABM-L1-10HW-G18-5-GR
		6 valve positions	573436	VABM-L1-10HW-G18-6-GR
		7 valve positions	573437	VABM-L1-10HW-G18-7-GR
		8 valve positions	573438	VABM-L1-10HW-G18-8-GR
		9 valve positions	573439	VABM-L1-10HW-G18-9-GR
		10 valve positions	573440	VABM-L1-10HW-G18-10-GR
		12 valve positions	573441	VABM-L1-10HW-G18-12-GR
		16 valve positions	573442	VABM-L1-10HW-G18-16-GR
		20 valve positions	573443	VABM-L1-10HW-G18-20-GR
		24 valve positions	573444	VABM-L1-10HW-G18-24-GR
		8 double solenoid + 8 single solenoid valves	573930	VABM-L1-10HW-G18-16-M-GR
		4 double solenoid + 16 single solenoid valves	573931	VABM-L1-10HW-G18-20-M-GR
		24 single solenoid valves	573932	VABM-L1-10HW-G18-24-M-GR
	For valve size G $\frac{1}{8}$			
	Port 2, 4 at front	4 valve positions	573500	VABM-L1-14W-G14-4-GR
		5 valve positions	573501	VABM-L1-14W-G14-5-GR
		6 valve positions	573502	VABM-L1-14W-G14-6-GR
		7 valve positions	573503	VABM-L1-14W-G14-7-GR
		8 valve positions	573504	VABM-L1-14W-G14-8-GR
		9 valve positions	573505	VABM-L1-14W-G14-9-GR
		10 valve positions	573506	VABM-L1-14W-G14-10-GR
		12 valve positions	573507	VABM-L1-14W-G14-12-GR
		16 valve positions	573508	VABM-L1-14W-G14-16-GR
		20 valve positions	573509	VABM-L1-14W-G14-20-GR
		24 valve positions	573510	VABM-L1-14W-G14-24-GR
		8 double solenoid + 8 single solenoid valves	573936	VABM-L1-14W-G14-16-M-GR
		4 double solenoid + 16 single solenoid valves	573937	VABM-L1-14W-G14-20-M-GR
		24 single solenoid valves	573938	VABM-L1-14W-G14-24-M-GR
	For valve size G $\frac{1}{4}$			
	Port 2, 4 at front	4 valve positions	8004913	VABM-L1-18W-G38-4-GR
		5 valve positions	8004914	VABM-L1-18W-G38-5-GR
		6 valve positions	8004915	VABM-L1-18W-G38-6-GR
		7 valve positions	8004916	VABM-L1-18W-G38-7-GR
		8 valve positions	8004917	VABM-L1-18W-G38-8-GR
		9 valve positions	8004918	VABM-L1-18W-G38-9-GR
		10 valve positions	8004919	VABM-L1-18W-G38-10-GR
		12 valve positions	8004920	VABM-L1-18W-G38-12-GR
		16 valve positions	8004921	VABM-L1-18W-G38-16-GR
		20 valve positions	8004922	VABM-L1-18W-G38-20-GR
		24 valve positions	8004923	VABM-L1-18W-G38-24-GR
8 double solenoid + 8 single solenoid valves		8004924	VABM-L1-18W-G38-16-M-GR	
4 double solenoid + 16 single solenoid valves		8004925	VABM-L1-18W-G38-20-M-GR	
24 single solenoid valves		8004926	VABM-L1-18W-G38-24-M-GR	

Valve terminals VTUG with multi-pin plug connection

Technical data – Multi-pin plug connection

The following multi-pin plug connections are available for the valve terminal VTUG:

- Sub-D (25-pin)
- Sub-D (44-pin)
- Flat cable (26-pin)
- Flat cable (50-pin)



Electrical multi-pin plug

Each pin on the multi-pin plug can actuate exactly one solenoid coil.

If the maximum configurable number of valve positions is 24, this means that 48 valve functions can be addressed. The valves can be switched by means of positive or negative logic (positive switching or negative switching).

Mixed operation is generally not possible; however, an exception is made for the V22 ... V25 variants with 25-pin Sub-D. With these variants, a specific range of valve positions (e.g. Com 16...19) is supplied with common voltage.

This allows these ranges to be switched with positive or negative logic and valve groups to be switched off independently of the other ranges. Mixed operation within a range is not permitted.



Note

A double solenoid valve occupies one valve position and two pins on the multi-pin plug. This means that the number of double solenoid valves per manifold rail is limited. (→ pin allocation page 172).

General technical data				
Type	VAEM-L1-S-M1-25	VAEM-L1-S-M1-44	VAEM-L1-S-M3-26	VAEM-L1-S-M3-50
Number of pins	25-pin	44-pin	26-pin	50-pin
Electrical connection	Sub-D plug		Flat cable plug	
Max. number of valve positions	24		24	
Degree of protection to EN 60529	IP67		IP40	
Material	PA		PA	
Note on materials	RoHS compliant		RoHS compliant	
Approval	c UL us - Recognized (OL)			
	c CSA us (OL)			
CE marking (see declaration of conformity)	To EU EMC Directive ¹⁾			
Corrosion resistance class CRC ²⁾	2			
Weight [g]	53		45	48

1) For information about the applicability of the component see the manufacturer's EC declaration of conformity at: www.festo.com/sp → Certificates. If the component is subject to restrictions on usage in residential, office or commercial environments or small businesses, further measures to reduce the emitted interference may be necessary.

2) Corrosion resistance class 2 according to Festo standard 940 070
Components subject to moderate corrosion stress. External visible parts with primarily decorative surface requirements which are in direct contact with the surrounding industrial environment or media such as coolants or lubricating agents.

Valve terminals VTUG with multi-pin plug connection

Technical data – Multi-pin plug connection

Pin allocation – Sub-D plug, 25-pin												
	Pin	Wire colour ¹⁾	M1-25 (V20)								M1-25V1 (V22)	
			12x double solenoid		8x double solenoid 8x single solenoid		4x double solenoid 16x single solenoid		24x single solenoid			
	1	WH	VP0	14	VP0	14	VP0	14	VP0	14	VP0	14
	2	BN	VP0	12	VP0	12	VP0	12	VP23	14	VP0	12
	3	GN	VP1	14	VP1	14	VP1	14	VP1	14	VP1	14
	4	YE	VP1	12	VP1	12	VP1	12	VP22	14	VP1	12
	5	GY	VP2	14	VP2	14	VP2	14	VP2	14	VP2	14
	6	PK	VP2	12	VP2	12	VP2	12	VP21	14	VP2	12
	7	BU	VP3	14	VP3	14	VP3	14	VP3	14	VP3	14
	8	RD	VP3	12	VP3	12	VP3	12	VP20	14	VP3	12
	9	BK	VP4	14	VP4	14	VP4	14	VP4	14	VP4	14
	10	VT	VP4	12	VP4	12	VP19	14	VP19	14	VP4	12
	11	GY PK	VP5	14	VP5	14	VP5	14	VP5	14	VP5	14
	12	RD BU	VP5	12	VP5	12	VP18	14	VP18	14	VP5	12
	13	GN WH	VP6	14	VP6	14	VP6	14	VP6	14	VP6	14
	14	BN GN	VP6	12	VP6	12	VP17	14	VP17	14	VP6	12
	15	YE WH	VP7	14	VP7	14	VP7	14	VP7	14	VP7	14
	16	BN YE	VP7	12	VP7	12	VP16	14	VP16	14	VP7	12
	17	GY WH	VP8	14	VP8	14	VP8	14	VP8	14	VP8	14
	18	BN GY	VP8	12	VP15	14	VP15	14	VP15	14	VP8	12
	19	WH PK	VP9	14	VP9	14	VP9	14	VP9	14	VP9	14
	20	BN PK	VP9	12	VP14	14	VP14	14	VP14	14	VP9	12
	21	BU WH	VP10	14	VP10	14	VP10	14	VP10	14	Com 16 ... 19	
	22	BN BU	VP10	12	VP13	14	VP13	14	VP13	14	Com 12 ... 15	
	23	RD WH	VP11	14	VP11	14	VP11	14	VP11	14	Com 8 ... 11	
	24	BN RD	VP11	12	VP12	14	VP12	14	VP12	14	Com 4 ... 7	
	25	BK WH	Com		Com		Com	Com	Com		Com 0 ... 3	

1) To IEC 60757
VP Valve position

Note
A grey field means that a double solenoid valve can be used, while a white field means that only single solenoid valves can be used.

Valve terminals VTUG with multi-pin plug connection

Technical data – Multi-pin plug connection

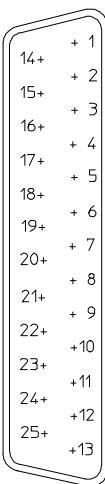
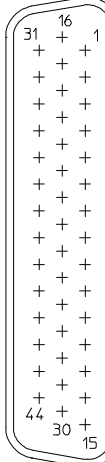
Pin allocation – Sub-D plug, 25-pin								Pin allocation – Sub-D plug, 44-pin					
	Pin	Wire colour ¹⁾	M1-25V2 (V23)		M1-25V3 (V24)		M1-25V4 (V25)		Pin	Wire colour ¹⁾	M1-44 (V21)		
													18x double solenoid, 6x single solenoid
	1	WH	VP0	14	VP0	14	VP0	14		1	WH	VP0	14
	2	BN	VP0	12	VP0	12	VP1	14		2	BN	VP0	12
	3	GN	VP1	14	VP1	14	VP2	14		3	GN	VP1	14
	4	YE	VP1	12	VP1	12	VP3	14		4	YE	VP1	12
	5	GY	VP2	14	VP2	14	VP4	14		5	GY	VP2	14
	6	PK	VP2	12	VP2	12	VP5	14		6	PK	VP2	12
	7	BU	VP3	14	VP3	14	VP6	14		7	BU	VP3	14
	8	RD	VP3	12	VP3	12	VP7	14		8	RD	VP3	12
	9	BK	VP4	14	VP4	14	VP8	14		9	BK	VP4	14
	10	VT	VP4	12	VP5	14	VP9	14		10	VT	VP4	12
	11	GY PK	VP5	14	VP6	14	VP10	14		11	GY PK	VP5	14
	12	RD BU	VP5	12	VP7	14	VP11	14		12	RD BU	VP5	12
	13	GN WH	VP6	14	VP8	14	VP12	14		13	GN WH	VP6	14
	14	BN GN	VP6	12	VP9	14	VP13	14		14	BN GN	VP6	12
	15	YE WH	VP7	14	VP10	14	VP14	14		15	YE WH	VP7	14
	16	BN YE	VP7	12	VP11	14	VP15	14		16	BN YE	VP7	12
	17	GY WH	VP8	14	VP12	14	VP16	14		17	GY WH	VP8	14
	18	BN GY	VP9	14	VP13	14	VP17	14		18	BN GY	VP8	12
	19	WH PK	VP10	14	VP14	14	VP18	14		19	WH PK	VP9	14
	20	BN PK	VP11	14	VP15	14	VP19	14		20	BN PK	VP9	12
	21	BU WH	Com 16 ... 19		Com 16 ... 19		Com 16 ... 19			21	BU WH	VP10	14
	22	BN BU	Com 12 ... 15		Com 12 ... 15		Com 12 ... 15			22	BN BU	VP10	12
	23	RD WH	Com 8 ... 11		Com 8 ... 11		Com 8 ... 11			23	RD WH	VP11	14
	24	BN RD	Com 4 ... 7		Com 4 ... 7		Com 4 ... 7			24	BN RD	VP11	12
	25	BK WH	Com 0 ... 3		Com 0 ... 3		Com 0 ... 3			25	BK WH	VP12	14
-								26	BK BN	VP12	12		
-								27	GN GY	VP13	14		
-								28	YE GY	VP13	12		
-								29	GN PK	VP14	14		
-								30	YE PK	VP14	12		
-								31	GN BU	VP15	14		
-								32	YE BU	VP15	12		
-								33	RD GN	VP16	14		
-								34	RD YE	VP16	12		
-								35	BK GN	VP17	14		
-								36	BK YE	VP17	12		
-								37	BU GY	VP18	14		
-								38	BU PK	VP19	14		
-								39	RD GY	VP20	14		
-								40	RD PK	VP21	14		
-								41	BK GY	VP22	14		
-								42	BK PK	VP23	14		
-								43	BK BU	Com			
-								44	BK RD				

1) To IEC 60757
VP Valve position

 - Note
A grey field means that a double solenoid valve can be used, while a white field means that only single solenoid valves can be used.

Valve terminals VTUG with multi-pin plug connection

Technical data – Multi-pin plug connection

Pin allocation – Flat cable, 26-pin										Pin allocation – Flat cable, 50-pin			
Pin	M3-26 (V20)								Pin	M3-50 (V26)			
	12x double solenoid		8x double solenoid 8x single solenoid		4x double solenoid 16x single solenoid		24x single solenoid						
1	VP0	14	VP0	14	VP0	14	VP0	14	1	VP0	14		
2	VP0	12	VP0	12	VP0	12	VP23	14	2	VP0	12		
3	VP1	14	VP1	14	VP1	14	VP1	14	3	VP1	14		
4	VP1	12	VP1	12	VP1	12	VP22	14	4	VP1	12		
5	VP2	14	VP2	14	VP2	14	VP2	14	5	VP2	14		
6	VP2	12	VP2	12	VP2	12	VP21	14	6	VP2	12		
7	VP3	14	VP3	14	VP3	14	VP3	14	7	VP3	14		
8	VP3	12	VP3	12	VP3	12	VP20	14	8	VP3	12		
9	VP4	14	VP4	14	VP4	14	VP4	14	9	VP4	14		
10	VP4	12	VP4	12	VP19	14	VP19	14	10	VP4	12		
11	VP5	14	VP5	14	VP5	14	VP5	14	11	VP5	14		
12	VP5	12	VP5	12	VP18	14	VP18	14	12	VP5	12		
13	VP6	14	VP6	14	VP6	14	VP6	14	13	VP6	14		
14	VP6	12	VP6	12	VP17	14	VP17	14	14	VP6	12		
15	VP7	14	VP7	14	VP7	14	VP7	14	15	VP7	14		
16	VP7	12	VP7	12	VP16	14	VP16	14	16	VP7	12		
17	VP8	14	VP8	14	VP8	14	VP8	14	17	VP8	14		
18	VP8	12	VP15	14	VP15	14	VP15	14	18	VP8	12		
19	VP9	14	VP9	14	VP9	14	VP9	14	19	VP9	14		
20	VP9	12	VP14	14	VP14	14	VP14	14	20	VP9	12		
21	VP10	14	VP10	14	VP10	14	VP10	14	21	VP10	14		
22	VP10	12	VP13	14	VP13	14	VP13	14	22	VP10	12		
23	VP11	14	VP11	14	VP11	14	VP11	14	23	VP11	14		
24	VP11	12	VP12	14	VP12	14	VP12	14	24	VP11	12		
25	Com		Com		Com	Com	Com		25	VP12	14		
26	Com		Com		Com		Com		26	VP12	12		
-									27	VP13	14		
-									28	VP13	12		
-									29	VP14	14		
-									30	VP14	12		
-									31	VP15	14		
-									32	VP15	12		
-									33	VP16	14		
-									34	VP16	12		
-									35	VP17	14		
-									36	VP17	12		
-									37	VP18	14		
-									38	VP18	12		
-									39	VP19	14		
-									40	VP19	12		
-									41	VP20	14		
-									42	VP20	12		
-									43	VP21	14		
-									44	VP21	12		
-									45	VP22	14		
-									46	VP22	12		
-									47	VP23	14		
-									48	VP23	12		
-									49	Com			
-									50				

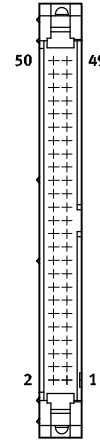
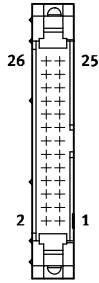

Note
A grey field means that a double solenoid valve can be used, while a white field means that only single solenoid valves can be used.

Valve terminals VTUG with multi-pin plug connection

Technical data – Multi-pin plug connection

Dimensions

Download CAD data → www.festo.com

Multi-pin plug connection, Sub-D

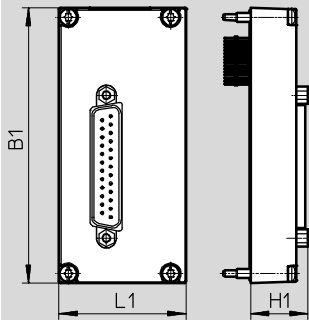

-  - Note
 Dimensions of the manifold rail with electrical connection
 (→ page 157)

Type	B1	L1	H1
VAEM-L1-S-M1-...	90.5	41.9	18.9

Dimensions

Download CAD data → www.festo.com

Multi-pin plug connection, flat cable

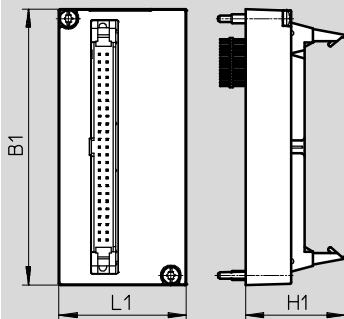



-  - Note
 Dimensions of the manifold rail with electrical connection
 (→ page 157)

Type	B1	L1	H1
VAEM-L1-S-M3-...	90.5	41.9	32.7

Valve terminals VTUG with multi-pin plug connection

Accessories – Multi-pin plug connection

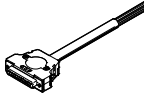
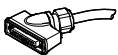
Ordering data – Multi-pin plug connection				
	Description		Part No.	Type
Electrical interface, Sub-D				
	25-pin	For variant M1-25 (V20)	573445	VAEM-L1-S-M1-25
		For variant M1-25V1 (V22)	573447	VAEM-L1-S-M1-25V1
		For variant M1-25V2 (V23)	573448	VAEM-L1-S-M1-25V2
		For variant M1-25V3 (V24)	573449	VAEM-L1-S-M1-25V3
	For variant M1-25V4 (V25)	573450	VAEM-L1-S-M1-25V4	
	44-pin	For variant M1-44 (V21)	573446	VAEM-L1-S-M1-44
Electrical interface, flat cable plug				
	26-pin	For variant M3-26 (V20)	573452	VAEM-L1-S-M3-26
	50-pin	For variant M3-50 (V26)	573451	VAEM-L1-S-M3-50
Connecting cable for multi-pin plug				
	Sub-D socket, straight	<ul style="list-style-type: none"> • 25-pin, up to 24 coils, IP40 • Open cable end, 25-wire 	Cable length 2.5 m	575417 NEBV-S1G25-K-2.5-N-LE25-S6
			Cable length 5 m	575418 NEBV-S1G25-K-5-N-LE25-S6
			Cable length 10 m	575419 NEBV-S1G25-K-10-N-LE25-S6
		<ul style="list-style-type: none"> • 44-pin, up to 42 coils, IP40 • Open cable end, 44-wire 	Cable length 2.5 m	575113 NEBV-S1G44-K-2.5-N-LE44-S6
			Cable length 5 m	575114 NEBV-S1G44-K-5-N-LE44-S6
			Cable length 10 m	575115 NEBV-S1G44-K-10-N-LE44-S6
	Sub-D socket, angled	<ul style="list-style-type: none"> • 25-pin, up to 24 coils, IP65 • Open cable end, 25-wire 	Cable length 2.5 m	575423 NEBV-S1WA25-K-2.5-N-LE25-S9
			Cable length 5 m	575424 NEBV-S1WA25-K-5-N-LE25-S9
			Cable length 10 m	575425 NEBV-S1WA25-K-10-N-LE25-S9
		<ul style="list-style-type: none"> • 44-pin, up to 42 coils, IP65 • Open cable end, 44-wire 	Cable length 2.5 m	575420 NEBV-S1WA44-K-2.5-N-LE44-S9
			Cable length 5 m	575421 NEBV-S1WA44-K-5-N-LE44-S9
			Cable length 10 m	575422 NEBV-S1WA44-K-10-N-LE44-S9

Valve terminals VTUG, I-Port interface/IO-Link

Technical data – I-Port interface/IO-Link

Festo-specific, standardised interface for direct connection to the fieldbus by mounting the bus node CTEU or to an IO-Link master via a cable (in IO-Link mode).

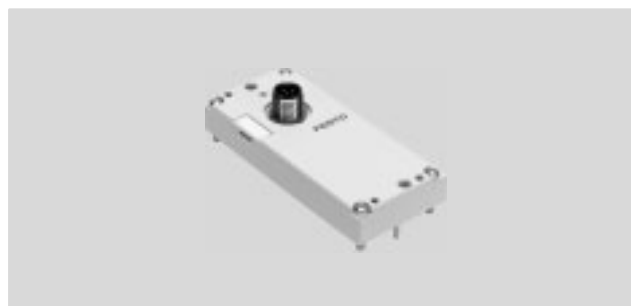

I-Port interface/IO-Link

Versions:

- I-Port interface for bus nodes (CTEU)
- IO-Link mode for direct connection to a higher-order IO-Link master

The following protocols are supported in connection with the associated CTEU bus node:

- CANopen
- DeviceNet
- PROFIBUS
- CC-LINK
- EtherCAT

The electrical supply/transmission of communication data takes place via an M12 plug connector.

The valve terminal can be equipped with 4 ... 24 (double solenoid) valves.

General technical data

Communication types	IO-Link		
Electrical connection	<ul style="list-style-type: none"> • Plug connector M12, 5-pin • A-coded • Metal thread for screening 		
Baud rates	COM3	[kbps]	230.4
	COM2	[kbps]	38.4
Intrinsic current consumption, logic supply PS		[mA]	30
Intrinsic current consumption, valve supply PL		[mA]	30
Max. number of solenoid coils	VAEM-L1-S-8-PT		16
	VAEM-L1-S-16-PT		32
	VAEM-L1-S-24-PT		48
Max. number of valve positions	VAEM-L1-S-8-PT		8
	VAEM-L1-S-16-PT		16
	VAEM-L1-S-24-PT		24
Ambient temperature		[°C]	-5 ... +50
Product weight	Outlet on top	[g]	49
	Outlet on the side	[g]	100
Degree of protection to EN 60529	IP67		
Approval certificate	c UL us - Recognised (OL)		
	c CSA us (OL)		
CE marking (see declaration of conformity)	To EU EMC Directive ¹⁾		
Corrosion resistance class CRC ²⁾	2		

1) For information about the applicability of the component see the manufacturer's EC declaration of conformity at: www.festo.com/sp → Certificates.

If the component is subject to restrictions on usage in residential, office or commercial environments or small businesses, further measures to reduce the emitted interference may be necessary.

2) Corrosion resistance class CRC 2 to Festo standard FN 940070

Moderate corrosion stress. Indoor applications in which condensation may occur. External visible parts with primarily decorative requirements for the surface and which are in direct contact with the ambient atmosphere typical for industrial applications.

Valve terminals VTUG, I-Port interface/IO-Link

Technical data – I-Port interface/IO-Link

LED display			
	Colour	Status	Function
Status LED X1	Red/ green	Off	No 24 V logic
		Static green	Everything OK
		Flashing green	Communication error (in the I-Port or IO-Link protocol)
		Flashing red/green	Load supply error (undervoltage or no load supply)
		Static red	Load supply error and communication error

Pin allocation – I-Port interface/IO-Link			
	Pin	Allocation	Description
	1	24V _{EL/SEN}	Operating voltage supply (electronics, sensors/inputs)
	2	24V _{VAL/OUT}	Load voltage supply (valves/outputs)
	3	0V _{EL/SEN}	Operating voltage supply (electronics, sensors/inputs)
	4	C/Q	Data communication
	5	0V _{VAL/OUT}	Load voltage supply (valves/outputs)

System overview – IO-Link

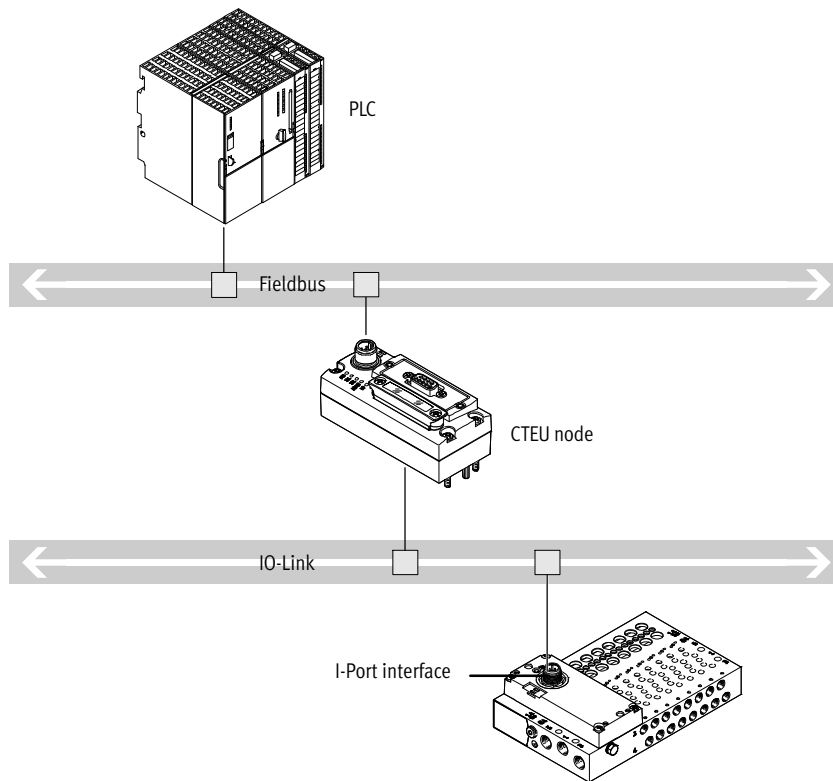

- Communication with the higher-order controller via fieldbus
- Use a bus node CTEU compatible with the fieldbus protocol
- Up to 64 inputs/outputs (solenoid coils), depending on the valve terminal
- No preprocessing

Valve terminals VTUG, I-Port interface/IO-Link

Technical data – I-Port interface/IO-Link

Dimensions

Download CAD data → www.festo.com

I-Port interface, outlet on top

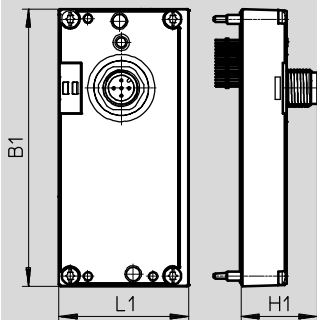

 Note
Dimensions of the manifold rail with electrical connection (→ page 157)



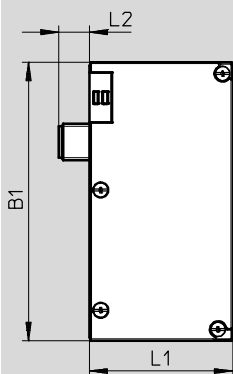

I-Port interface, outlet on the side

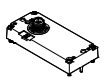

 Note
Dimensions of the manifold rail with electrical connection (→ page 157)

Type	Outlet on top			Outlet on the side		
	B1	L1	H1	B1	L1	L2
VAEM-L1-S-...	91	42.5	25	91.5	47.1	10

Ordering data

	Description	Part No.	Type
Electrical interface for I-Port interface/IO-Link, outlet on top			
	Actuation of up to 8 double solenoid valve positions	573384	VAEM-L1-S-8-PT
	Actuation of up to 16 double solenoid valve positions	573939	VAEM-L1-S-16-PT
	Actuation of up to 24 double solenoid valve positions	573940	VAEM-L1-S-24-PT
Electrical interface for I-Port interface/IO-Link, outlet on the side			
	Actuation of up to 8 double solenoid valve positions	574207	VAEM-L1-S-8-PTL
	Actuation of up to 16 double solenoid valve positions	574208	VAEM-L1-S-16-PTL
	Actuation of up to 24 double solenoid valve positions	574209	VAEM-L1-S-24-PTL
Connection technology for IO-Link			
	T-adapter M12, 5-pin for IO-Link and load supply	171175	FB-TA-M12-5POL
	Straight plug connector, M12, 5-pin, for T-adapter FB-TA	175487	SEA-M12-5GS-PG7
Inscription label for I-Port interface/IO-Link			
	40 pieces in frame	565306	ASLR-C-E4

Valve terminals VTUG, connecting blocks CAPC

Technical data – CAPC

FESTO

Function

The connecting block CAPC enables decentralised installation of bus nodes CTEU on a valve terminal or input modules with I-Port interface.

Application

- M12 connection technology (two interfaces)
- Enables the installation of valve terminals or other devices over a distance of 20 metres
- Accessory CAFM enables the sub-base to be installed on an H-rail



General technical data		
Type		CAPC-F1-E-M12
Dimensions W x L x H	[mm]	50 x 148 x 28
Fieldbus interface		2x M12 socket, 5-pin
Operating voltage range	[V DC]	18 ... 30
Max. power supply	[A]	2
Nominal operating voltage	[V DC]	24
Product weight	[g]	85
Cable length	[m]	20

Materials	
Housing	PA reinforced
Note on materials	RoHS compliant

Operating and environmental conditions	
Degree of protection to EN 60529	IP65, IP67
Ambient temperature	[°C] -5 ... +50
Storage temperature	[°C] -20 ... +70
Corrosion resistance class CRC ¹⁾	2 ¹⁾
CE marking (see declaration of conformity)	To EU EMC Directive ²⁾

1) Corrosion resistance class 2 according to Festo standard 940 070

Components subject to moderate corrosion stress. External visible parts with primarily decorative surface requirements which are in direct contact with the surrounding industrial environment or media such as coolants or lubricating agents.

2) For information about the applicability of the component see the manufacturer's EC declaration of conformity at: www.festo.com/sp → Certificates.

If the component is subject to restrictions on usage in residential, office or commercial environments or small businesses, further measures to reduce the emitted interference may be necessary.

Pin allocation for power supply/IO-Link interfaces			
	Pin	Allocation	Description
	1	24V _{EL/SEN}	Operating voltage supply (electronics, sensors/inputs)
	2	24V _{VAL/OUT}	Load voltage supply (valves/outputs)
	3	0V _{EL/SEN}	Operating voltage supply (electronics, sensors/inputs)
	4	C/Q	Data communication
	5	0V _{VAL/OUT}	Load voltage supply (valves/outputs)
			Housing, FE

Valve terminals VTUG, connecting blocks CAPC

Technical data – CAPC

Dimensions

Download CAD data → www.festo.com

CAPC

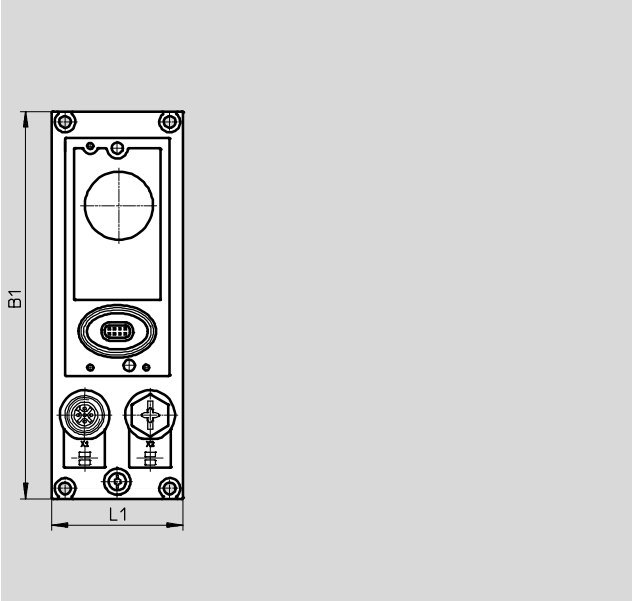

CAPC with mounted bus node CTEU-CO

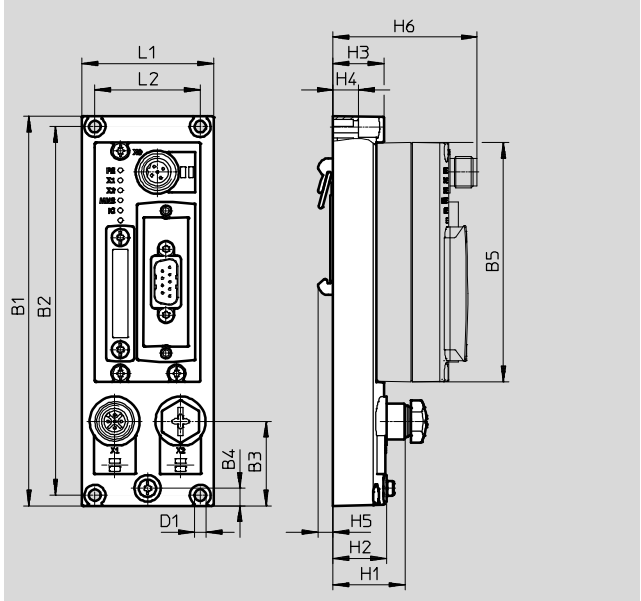

Type	B1	B2	B3	B4	B5	D1-∅	H1	H2	H3	H4	H5	H6	L1	L2
CAPC	148	140	32	6.6	91	4.4	27.3	20.3	19.3	9.6	5.7	54.8	50	40

Ordering data

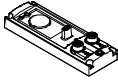
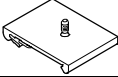
		Part No.	Type
Connecting block			
	For connecting a second device with I-Port interface	570042	CAPC-F1-E-M12
H-rail mounting			
	For connecting block CAPC	570043	CAF-M-F1-H

Valve terminals VTUG with interlock

Technical data – Interlock

FESTO

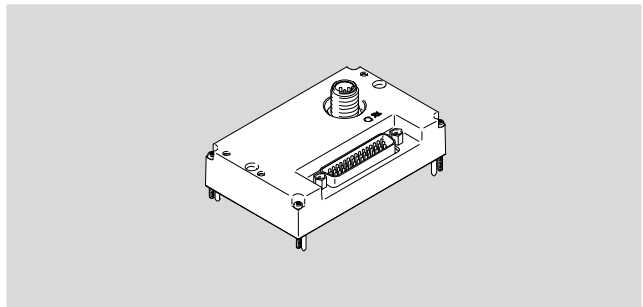

Interlock

The interlock function enables the first 16 solenoid coils to be individually supplied externally.

This guarantees the safety-related release of these valves.

The interlock interface is established via external contacts for a single-pin connection or via safety output terminals for a double-pin connection.

General technical data			
Communication types		I-Port/IO-Link	
Number of valve positions		4...24	
Max. number of solenoid coils		48	
Number of interlock solenoid coils		16	
Number of inputs for reading back voltage		18 (16x interlock + 2 group supply)	
Mounting position		Any	
Nominal flow rate		[l/min]	330
Product weight		[g]	80
Residual ripple		[V _{SS}]	4
Baud rate	COM3	[kbps]	230.4
	COM2	[kbps]	38.4
IO-Link	Protocol	V1.0	
	Connection technology	M12, A-coded	
	Port type	Type B	
	Number of ports	1	
	Process data width OUT	6 bytes	
	Process data width IN	4 bytes	
	Minimum cycle time	11.5 ms (2.3 ms per frame = 2 bytes of user data)	
Corrosion resistance class CRC ¹⁾		2	

1) Corrosion resistance class 2 according to Festo standard 940070

Components subject to moderate corrosion stress. Externally visible parts with primarily decorative surface requirements which are in direct contact with a normal industrial environment or media such as coolants or lubricating agents.

Valve terminals VTUG with interlock

Technical data – Interlock

Interlock interface

Single-pin interlock interface

- The interlock interface is established via external positive switching contacts or single-pin switching safety terminals
- 16 solenoid coils can be actuated via the interlock (Vn+)
- Solenoid coils that do not require interlock actuation can be supplied directly with 24 V from pins 1 ... 3
- Application of the respective input voltage is reported via the fieldbus as an image table

Double-pin interlock interface

- The interlock interface is established via external positive-negative switching safety terminals
- The solenoid coils of the interlock valves are actuated via the corresponding pins in the sub-D plug connector (pins 7 ... 38)
- The solenoid coils that do not require interlock actuation can be supplied directly with 24 V (e.g. from pins 1 ... 3)
- Any difference in potential between Vn- and 0 VVAL/OUT must be below 5 V

Sample circuit diagram for a single-pin interlock interface

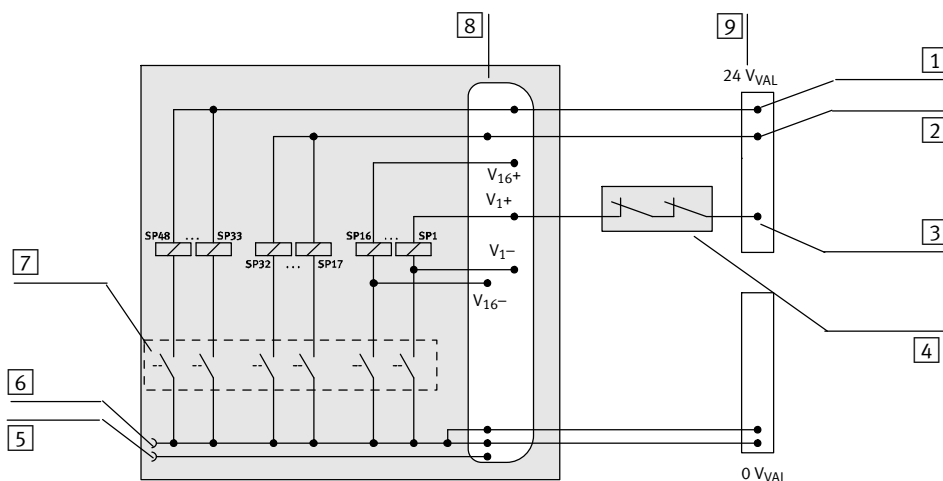

- 1 Power supply V+, solenoid coils 33 ... 48 (no interlock)
- 2 Power supply V+, solenoid coils 17 ... 32 (no interlock)
- 3 Actuation Vn+ (via interlock)
- 4 Interlock contacts of the output terminal
- 5 I-Port connection pin 2, 24 VVAL/OUT (PL), load voltage supply
- 6 I-Port connection pin 5, 0 VVAL/OUT (PL), load voltage supply
- 7 Driver, actuated via fieldbus/I-Port
- 8 Interlock Sub-D connection
- 9 Power supply (interlock)

Sample circuit diagram for a double-pin interlock interface

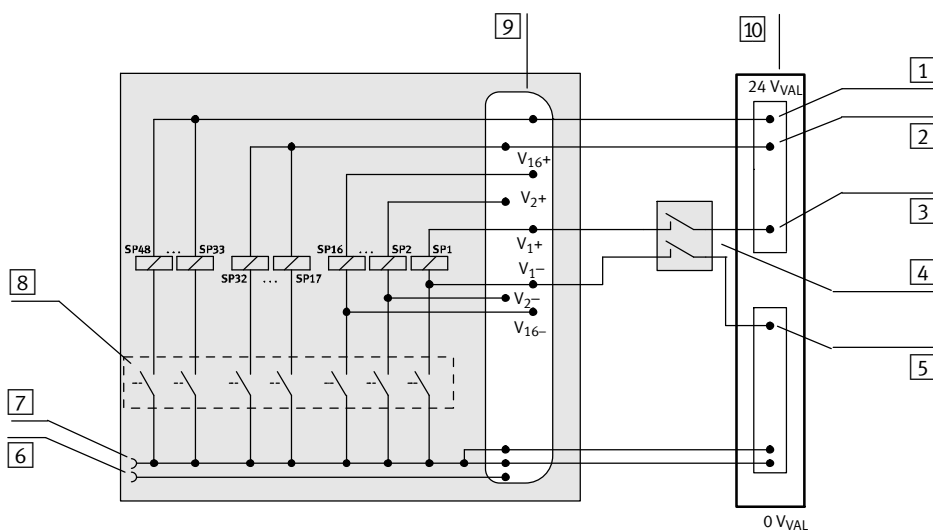

- 1 Power supply V+, solenoid coils 33 ... 48 (no interlock)
- 2 Power supply V+, solenoid coils 17 ... 32 (no interlock)
- 3 Actuation Vn+ (via interlock)
- 4 Interlock contacts of the output terminal
- 5 Actuation Vn- (via interlock)
- 6 I-Port connection pin 2, 24 VVAL/OUT (PL), load voltage supply
- 7 I-Port connection pin 5, 0 VVAL/OUT (PL), load voltage supply
- 8 Driver, actuated via fieldbus/I-Port
- 9 Interlock Sub-D connection
- 10 Power supply (interlock)

Valve terminals VTUG with interlock

Technical data – Interlock

Pin allocation – Interlock									
	Pin	Coil	Signal	Pin	Coil	Signal	Pin	Coil	Signal
	1	-	24 V _{VAL/OUT}	16	5	V5-	31	13	V13+
	2	-	24 V _{VAL/OUT}	17	6	V6+	32	13	V13-
	3	-	24 V _{VAL/OUT}	18	6	V6-	33	14	V14+
	4	1 ... 48	0 V _{VAL/OUT}	19	7	V7+	34	14	V14-
	5	1 ... 48	0 V _{VAL/OUT}	20	7	V7-	35	15	V15+
	6	1 ... 48	0 V _{VAL/OUT}	21	8	V8+	36	15	V15-
	7	1	V1+	22	8	V8-	37	16	V16+
	8	1	V1-	23	9	V9+	38	16	V16-
	9	2	V2+	24	9	V9-	39	17 ... 32	V17 ... 32+
	10	2	V2-	25	10	V10+	40	33 ... 48	V33 ... 48+
	11	3	V3+	26	10	V10-	41	1 ... 48	0 V _{VAL/OUT}
	12	3	V3-	27	11	V11+	42	1 ... 48	0 V _{VAL/OUT}
	13	4	V4+	28	11	V11-	43	1 ... 48	0 V _{VAL/OUT}
	14	4	V4-	29	12	V12+	44	-	n.c.
	15	5	V5+	30	12	V12-	Housing		FE

Pin allocation – I-Port interface/IO-Link			
	Pin	Allocation	Description
	1	24V _{EL/SEN}	Operating voltage supply (electronics, sensors/inputs)
	2	24V _{VAL/OUT}	Load voltage supply (valves/outputs)
	3	0V _{EL/SEN}	Operating voltage supply (electronics, sensors/inputs)
	4	C/Q	Data communication
	5	0V _{VAL/OUT}	Load voltage supply (valves/outputs)
	Housing, FE		Functional earth

Dimensions Download CAD data → www.festo.com

I-Port interface with interlock, outlet on top







Note

Dimensions of the manifold rail with electrical connection (→ page 157)

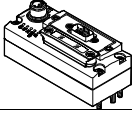
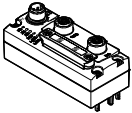
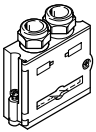
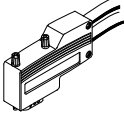
Type	Outlet on top		
	B1	L1	H1
VAEM-L1-S-24-PTK	91	57	30.8

Valve terminals VTUG with multi-pin plug and fieldbus connection

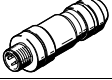
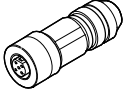
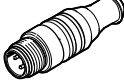



Accessories – Valve terminal

Ordering data – CTEU			
	Description	Part No.	Type
Bus node			
	CANopen bus node	570038	CTEU-CO
	CC-Link bus node	1544198	CTEU-CC
	PROFIBUS bus node	570040	CTEU-PB
	DeviceNet bus node	570039	CTEU-DN
	EtherCAT bus node	572556	CTEU-EC
Bus connection			
	Sub-D plug connector, straight	For CANopen	532219 FBS-SUB-9-BU-2x5POL-B
		For CC-Link	532220 FBS-SUB-9-GS-2x4POL-B
		For PROFIBUS	532216 FBS-SUB-9-GS-DP-B
	Sub-D plug connector, angled, 9-pin	For CANopen	533783 FBS-SUB-9-WS-CO-K
		For PROFIBUS	533780 FBS-SUB-9-WS-PB-K
	M12x1, 5-pin	A-coded, for CANopen	525632 FBA-2-M12-5POL
		B-coded, for PROFIBUS	533118 FBA-2-M12-5POL-RK
	For 5-pin terminal strip for CANopen	525634	FBA-1-SL-5POL
	Terminal strip, 5-pin, for DeviceNet/CANopen	525635	FBSD-KL-2x5POL
	Screw terminal for CC-Link	197962	FBA-1-KL-5POL
	Straight plug connector, M12x1	5-pin, for CANopen	175380 FBS-M12-5GS-PG9
		4-pin, D-coded for EtherCAT	543109 NECU-M-S-D12G4-C2-ET
		5-pin, compatible with FBA-2-M12-5POL-RK for PROFIBUS	1066354 NECU-M-S-B12G5-C2-PB
	Straight socket, M12x1, 5-pin, for assembling a connecting cable compatible with FBA-2-M12-5POL-RK for PROFIBUS	1067905	NECU-M-B12G5-C2-PB
	Terminating resistor, M12, B-coded for PROFIBUS	1072128	CACR-S-B12G5-220-PB
Plug socket			
	For power supply, M12x1, 5-pin, B-coded for CANopen/DeviceNet	538999	NTSD-GD-9-M12-5POL-RK
	For power supply, M12x1, 5-pin for CC-Link, PROFIBUS, EtherCAT	18324	FBSD-GD-9-5POL
Inscription label			
	For bus node	565306	ASLR-C-E4

Valve terminals VTUG with multi-pin plug and fieldbus connection

FESTO

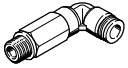









Accessories – Valve terminal

Ordering data						
Description		Part No.	Type	PU ¹⁾		
Push-in fitting, straight Technical data → Internet: qsm						
	M5 thread	For tubing Ø 3 mm	–	153313	QSM-M5-3-I	10
		Round releasing ring		133003	QSM-M5-3-I-R	10
	M5 thread	For tubing Ø 4 mm	–	153315	QSM-M5-4-I	10
		Round releasing ring		133004	QSM-M5-4-I-R	10
	M5 thread	For tubing Ø 6 mm	–	133005	QSM-M5-6-I-R	10
		Round releasing ring		133007	QSM-M5-6-I-R	10
	M7 thread	For tubing Ø 4 mm	–	153319	QSM-M7-4-I	10
		Round releasing ring		133007	QSM-M7-6-I-R	10
	G1/8 thread	For tubing Ø 4 mm	–	186106	QS-G1/8-4-I	10
		For tubing Ø 6 mm	–	186107	QS-G1/8-6-I	10
		For tubing Ø 8 mm	–	186109	QS-G1/8-8-I	10
		For tubing Ø 10 mm	–	132151	QS-B-1/8-10-I-20	20
	G1/4 thread	For tubing Ø 8 mm	–	132280	QS-B-1/4-8-I	1
			–	130995	QS-B-1/4-8-I-20	20
		For tubing Ø 10 mm	–	132842	QS-B-1/4-10-I	1
			–	132152	QS-B-1/4-10-I-20	20
	G3/8 thread	For tubing Ø 8 mm	–	130921	QS-B-3/8-8-10	10
		For tubing Ø 10 mm	–	130922	QS-B-3/8-10-10	10
		For tubing Ø 12 mm	–	132123	QS-B-3/8-12-10	10
		For tubing Ø 16 mm	–	132124	QS-B-3/8-16-10	10
Push-in fitting, angled Technical data → Internet: qsl						
	M5 thread	For tubing Ø 3 mm	–	153331	QSML-M5-3	10
		For tubing Ø 4 mm	–	153333	QSML-M5-4	10
	M7 thread	For tubing Ø 4 mm	–	186352	QSML-M7-4	10
		For tubing Ø 6 mm	–	132111	QSML-B-1/8-6-20	20
	G1/8 thread	For tubing Ø 6 mm	–	186117	QSL-G1/8-6	10
		For tubing Ø 8 mm	–	186119	QSL-G1/8-8	10
		For tubing Ø 10 mm	–	132126	QSL-B-1/8-10-20	20
	G1/4 thread	For tubing Ø 8 mm	–	132220	QSL-B-1/4-8	1
		For tubing Ø 8 mm	–	130931	QSL-B-1/4-8-20	20
		For tubing Ø 10 mm	–	132817	QSL-B-1/4-10	1
		For tubing Ø 10 mm	–	132127	QSL-B-1/4-10-20	20
		For tubing Ø 12 mm	–	132128	QSL-B-1/4-12-20	20
Push-in fitting, long, angled Technical data → Internet: qsl						
	M5 thread	For tubing Ø 3 mm	–	130838	QSMLL-M5-3	10
		For tubing Ø 4 mm	–	153339	QSMLL-M5-4	10
	M7 thread	For tubing Ø 4 mm	–	186354	QSMLL-M7-4	10
	G1/8 thread	For tubing Ø 6 mm	–	186128	QSLL-G1/8-6	10
		For tubing Ø 8 mm	–	186130	QSLL-G1/8-8	10
Blanking plug Technical data → Internet: b						
	For M5 thread			174308	B-M5-B	10
	For M7 thread			174309	B-M7	10
	For G1/8 thread			3568	B-1/8	10
	For G1/4 thread			3569	B-1/4	10

1) Packaging unit.

Valve terminals VTUG with multi-pin plug and fieldbus connection

Accessories – Valve terminal



Ordering data						
	Description	Part No.	Type	PU ¹⁾		
Silencer Technical data → Internet: amte						
	For M5 thread	165003	UC-M5	1		
	For M7 thread	161418	UC-M7	1		
	For G ¹ / ₈ thread	161419	UC-1/8	1		
		534222	U-1/8-50	50		
	For G ¹ / ₄ thread	High flow rate	2316	U-1/4	1	
			534223	U-1/4-20	20	
		Lower flow rate	165004	UC-1/4	1	
534220			UC-1/4-20	20		
Blanking plate						
	Vacant position width 10 mm	573422	VABB-L1-10-T	1		
	Vacant position width 14 mm	573488	VABB-L1-14-T	1		
	Vacant position width 18 mm	8004897	VABB-L1-18-T	1		
Supply plate						
	Supply ports 1, 3, 5, width 10 mm	573924	VABF-L1-10-P3A4-M7-T1	1		
	Supply ports 1, 3, 5, width 14 mm	573925	VABF-L1-14-P3A4-G18-T1	1		
	Supply ports 1, 3, 5, width 18 mm	8004898	VABF-L1-18-P3A4-G14-T1	1		
Separator						
	For manifold rail, size 10, M5/M7	For sub-base valves	569994	VABD-6-B	1	
		For semi in-line valves	569995	VABD-8-B	1	
	For all manifold rails, size 14, G ¹ / ₈		569996	VABD-10-B	1	
	For all manifold rails, size 18, G ¹ / ₄		569997	VABD-12-B	1	
Cover cap for manual override						
	Covered	540898	VMPA-HBV-B	10		
	Non-detenting	540897	VMPA-HBT-B	10		
	Detenting (without accessories)	8002234	VAMC-L1-CD	10		
Inscription label holder Technical data → Internet: aslr						
	Holder for an inscription label and covering the mounting screw and manual override	570818	ASLR-D-L1	10		
Flow control						
	For M5 valves, for setting the flow rate during pressurisation and exhausting b value: 0.5	Flow rate: 9.6 l/min	C value: 0.04	8025709	VFFG-T-M5-5	10
		Flow rate: 14.6 l/min	C value: 0.05	8025710	VFFG-T-M5-6	10
		Flow rate: 19.1 l/min	C value: 0.07	8025711	VFFG-T-M5-7	10
		Flow rate: 26.1 l/min	C value: 0.10	8025712	VFFG-T-M5-8	10
		Flow rate: 40.8 l/min	C value: 0.14	8025713	VFFG-T-M5-10	10
		Flow rate: 45.4 l/min	C value: 0.16	8025714	VFFG-T-M5-12	10
		Flow rate: 67.4 l/min	C value: 0.25	8025715	VFFG-T-M5-15	10
Restrictor set						
	Two of each size	8025716	VFFG-T-M5-A-V1	14		

1) Packaging unit.

Valve terminals VTUG with multi-pin plug and fieldbus connection

FESTO

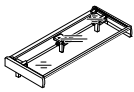
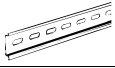
Accessories – Valve terminal

Ordering data					
	Description	Part No.	Type		
Inscription label holder for valve terminal					
	Size 10	For 4 valve positions	573453	ASCF-H-L1-10-4V	
		For 5 valve positions	573454	ASCF-H-L1-10-5V	
		For 6 valve positions	573455	ASCF-H-L1-10-6V	
		For 7 valve positions	573456	ASCF-H-L1-10-7V	
		For 8 valve positions	573457	ASCF-H-L1-10-8V	
		For 9 valve positions	573458	ASCF-H-L1-10-9V	
		For 10 valve positions	573459	ASCF-H-L1-10-10V	
		For 12 valve positions	573460	ASCF-H-L1-10-12V	
		For 16 valve positions	573461	ASCF-H-L1-10-16V	
		For 20 valve positions	573462	ASCF-H-L1-10-20V	
			For 24 valve positions	573463	ASCF-H-L1-10-24V
		Size 14	For 4 valve positions	573511	ASCF-H-L1-14-4V
			For 5 valve positions	573512	ASCF-H-L1-14-5V
			For 6 valve positions	573513	ASCF-H-L1-14-6V
			For 7 valve positions	573514	ASCF-H-L1-14-7V
			For 8 valve positions	573515	ASCF-H-L1-14-8V
			For 9 valve positions	573516	ASCF-H-L1-14-9V
			For 10 valve positions	573518	ASCF-H-L1-14-10V
			For 12 valve positions	573519	ASCF-H-L1-14-12V
			For 16 valve positions	573520	ASCF-H-L1-14-16V
			For 20 valve positions	573521	ASCF-H-L1-14-20V
			For 24 valve positions	573522	ASCF-H-L1-14-24V
		Size 18	For 4 valve positions	8004928	ASCF-H-L1-18-4V
			For 5 valve positions	8004929	ASCF-H-L1-18-5V
			For 6 valve positions	8004930	ASCF-H-L1-18-6V
			For 7 valve positions	8004931	ASCF-H-L1-18-7V
			For 8 valve positions	8004932	ASCF-H-L1-18-8V
			For 9 valve positions	8004933	ASCF-H-L1-18-9V
			For 10 valve positions	8004934	ASCF-H-L1-18-10V
			For 12 valve positions	8004935	ASCF-H-L1-18-12V
	For 16 valve positions		8004936	ASCF-H-L1-18-16V	
	For 20 valve positions		8004937	ASCF-H-L1-18-20V	
		For 24 valve positions	8004938	ASCF-H-L1-18-24V	
H-rail Technical data → Internet: nrh					
	To EN 60715, 35 x 7.5 (WxH)	Length: 2 m	35430	NRH-35-2000	
H-rail mounting Technical data → Internet: vame					
	Use the following screws for mounting: Size 10: M4x30 to DIN 912 Size 14: M4x40 to DIN 912 Size 18: DIN 912: M5x50		569998	VAME-T-M4	